



SPECIFICATION FOR LCD MODULE

CUSTOMER: TM Standard LCM

CUSTOMER NO.: -----

PRODUCT NO.: TM9616AGHWGNA

PRODUCT TYPE: Graphic Matrix STN

VERSION: V2.0

- Preliminary specification
- Final specification

CUSTOMER APPROVED	
-------------------	--

PREPARED BY	CHECKED BY	VERIFIED BY QA DEPT.	APPROVED BY
周礼新 9/4-08	陈云康 9/4-08	唐懿峰 9/4-08	徐明华 9/6-08

<p>Tianma Europe GmbH Herrenalber Strasse 22; D-76199 Karlsruhe Phone: +49-(0)721-89311-0; Fax +49-(0)721-89311-20 www.tianma.eu, info@tianma.eu</p>

TABLE OF CONTENTS

1 Description.....	3
2 Features.....	3
3 Absolute maximum ratings.....	4
4 Mechanical Characteristics.....	4
4.1 Mechanical features.....	4
4.2 Mechanical drawing.....	5
5 Circuit.....	6
5.1 Block Diagram.....	6
6 Interface description.....	7
7 Instruction Code & Timing characteristics.....	8
7.1 Command and initial code.....	8
7.2 Interface Timing characteristics.....	9
7.3 Reset Timing.....	10
8 Electrical characteristics.....	10
9 Optical Characteristics.....	11
10 Reliability.....	14
10.1 Content of Reliability Test.....	14
10.2 Inspection of criteria.....	15
11 Package.....	15
12 Quality level.....	16
13 Precautions for Use of LCD Modules.....	16
13.1 Handling Precautions.....	16
13.2 Storage precautions.....	17
13.3 Transportation precautions.....	17
13.4 Soldering.....	17
14. LCD Module Part Numbering System.....	18
Appendix A.....	19
Appendix B.....	21

1 Description

The TM9616AGHWGNA, a graphic LCM unit which consists of 96(segment)×16(common) dots, dot-matrix LCD panel, LCD driver, and a FPC. With an IC of COG type, without a backlight unit.

- ◆ Wide temperature range
- ◆ COG type
- ◆ Without a backlight unit
- ◆ Requirements on environmental protection: RoHS.

2 Features

Item	Contents
LCD type	FSTN
	Negative
LCD Duty	1/17
LCD Bias	1/5
Polarizer	Transmissive
LCD background color	Black
Segment color	White
View direction	6:00 o'clock
Operating temperature	-10°C~60°C
Storage temperature	-20°C~70°C
LCD Controller	ST7579
Technology	COG
Data Transfer	8 Bit parallel

3 Absolute maximum ratings

(VSS=0V, Ta=25°C)

Parameter	Symbol	Min	Max	Unit	Remark
Logic circuit supply voltage	VDD	-0.3	+3.6	V	---
Input voltage of logic control or data pins	V _I	-0.3	VDD+0.3	V	---
LCD driving voltage	XV0/V0	-0.3	+10.5	V	Note [3-2]
Operating temperature range	T _{OP}	-10	+60	°C	Note [3-3]
Storage temperature range	T _{ST}	-20	+70	°C	

Note [3-1]: No parameter is allowed to exceed these maximum ratings.

Note [3-2]: LCD operating voltage is calculated as |XV0/V0|.

Note [3-3]: 95% RH MAX (40 °C ≥ Ta);

Maximum wet-bulb temperature is 39°C or less. (Ta >40 °C) No dew condensation.

Note [3-4]: Only operation is guaranteed at operating temperature. Contrast, response time and another display quality are evaluated at +25°C.

4 Mechanical Characteristics

4.1 Mechanical features

Parameter	Standard Value	Unit
Display type	Graphics Matrix LCM	--
Number of dots	96 × 16	--
View area (W×H)	22.7 × 4.5	mm
Active Area (W×H)	21.1 × 3.5	mm
Dot Size (W×H)	0.2 × 0.2	mm
Dot Pitch (W×H)	0.22 × 0.22	mm
Module size(W×H×D)	25.1 × 10.2 × 1.5 (Without FPC)	mm
Module total weight (approx.)	(TBD)	g

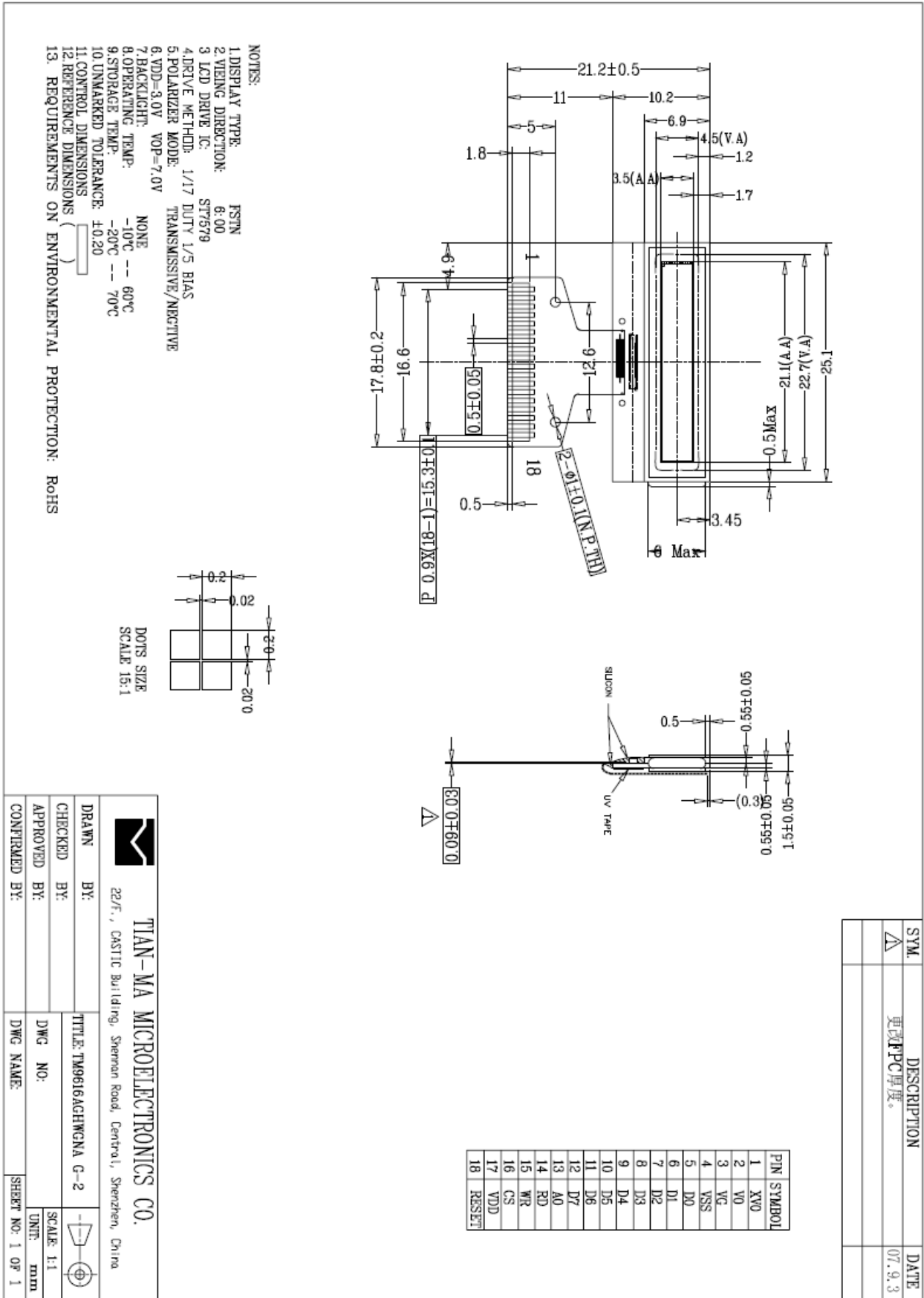
4.2 Mechanical drawing

5 Circuit

5.1 Block Diagram

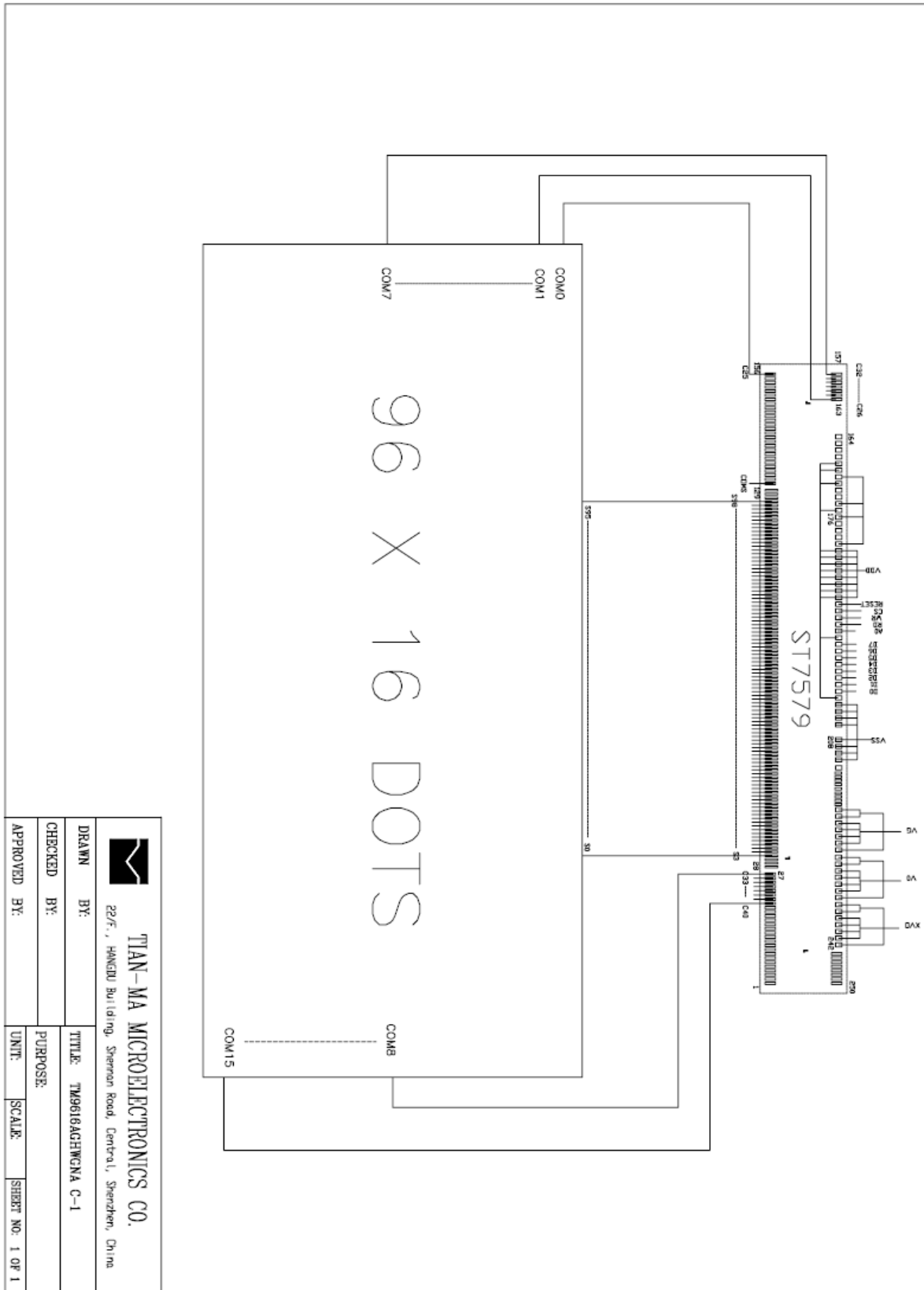

6 Interface description

Pin No.	Symbol	I/O	Description
1	XV0	P	Negative LCD driver supply voltage. Connect a capacitor to V0
2	V0	P	Positive LCD driver supply voltage. Connect a capacitor to XV0
3	VG	P	LCD driving voltage for segment. Connect a capacitor to Ground.
4	VSS	P	Ground
5	D0	I/O	8-bit parallel databus
6	D1	I/O	
7	D2	I/O	
8	D3	I/O	
9	D4	I/O	
10	D5	I/O	
11	D6	I/O	
12	D7	I/O	
13	A0	I	Data/instruction control selection pin. A0=High, it indicates that D[0:7] are data bits. A0=Low, D[0:7] are instruction bits
14	RD	I	Read execution input signal
15	WR	I	Write execution input signal
16	CS	I	Chip selection input signal. Low active
17	VDD	P	Power supply for LCD Driver(Typical value: +3.0V)
18	RESET	I	Reset execution input signal. Low active

7 Instruction Code & Timing characteristics

7.1 Command and initial code

The module TM9616AGHWGNA includes ST7579 as its driver. After reset, we have to use some commands to set up the display. And we may use this when we want to change the display type. We explain some commands below. For more details, please refer to the datasheet of ST7579.

INSTRUCTION	A0	WR (R/W)	COMMAND BYTE								DESCRIPTION
			D7	D6	D5	D4	D3	D2	D1	D0	
H independent instruction											
NOP	0	0	0	0	0	0	0	0	0	0	No operation
Reserved	0	0	0	0	0	0	0	0	0	1	Do not use
Function set	0	0	0	0	1	MX	MY	PD	H1	H0	Power-down; entry mode; Extended instruction control
Read status byte	0	1	PD	0	0	D	E	MX	MY	DO	Read status byte
Read data	1	1	D7	D6	D5	D4	D3	D2	D1	D0	Read data to RAM
Write data	1	0	D7	D6	D5	D4	D3	D2	D1	D0	Write data to RAM

INSTRUCTION	A0	WR (R/W)	COMMAND BYTE								DESCRIPTION
			D7	D6	D5	D4	D3	D2	D1	D0	
H[1:0]=[0:0]											
Reserved	0	0	0	0	0	0	0	0	1	X	Do not use
Set V _{LCD} range	0	0	0	0	0	0	0	1	0	PRS	V _{LCD} range L/H select
END	0	0	0	0	0	0	0	1	1	0	Release read/modify/write
Read/modify/write	0	0	0	0	0	0	0	1	1	1	RAM address at R:+0, W:+1
Display control	0	0	0	0	0	0	1	D	0	E	Sets display configuration
Reserved	0	0	0	0	0	1	0	0	X	X	Do not use
Set Y address of RAM	0	0	0	1	0	0	Y ₃	Y ₂	Y ₁	Y ₀	Sets Y address of RAM 0 ≤ Y ≤ 9
Set X address of RAM	0	0	1	X ₆	X ₅	X ₄	X ₃	X ₂	X ₁	X ₀	Sets X address of RAM 0 ≤ X ≤ 101
H[1:0]=[0:1]											
Reserved	0	0	0	0	0	0	0	0	1	X	Do not use
Display configuration	0	0	0	0	0	0	1	DO	X	X	Top/bottom row mode set data order
Bias system	0	0	0	0	0	1	0	BS ₂	BS ₁	BS ₀	Sets bias system (BSx)
Set Start line S6	0	0	0	0	0	0	0	1	0	S6	Specify the initial display line S6
Set Start line	0	0	0	1	S5	S4	S3	S2	S1	S0	Specify the initial display line to realize vertical scrolling
Set V _{OP}	0	0	1	V _{OP6}	V _{OP5}	V _{OP4}	V _{OP3}	V _{OP2}	V _{OP1}	V _{OP0}	Write V _{OP} to register

INSTRUCTION	A0	WR (R/W)	COMMAND BYTE								DESCRIPTION
			D7	D6	D5	D4	D3	D2	D1	D0	
H[1:0]=[1:0]											
Reserved	0	0	0	0	0	0	0	0	1	X	Do not use
Partial screen mode	0	0	0	0	0	0	0	1	0	PS	Partial screen enable
Partial screen size	0	0	0	0	0	0	1	0	0	WS	Set partial screen size
Display part	0	0	0	0	0	1	0	DP2	DP1	DP0	Set display part for partial screen mode
H[1:0]=[1:1]											
Test command mode	0	0	0	0	0	0	0	0	0	TEN	Test command enable/disable
RESET	0	0	0	0	0	0	0	0	1	1	Software reset
Display control	0	0	0	0	0	0	1	FR2	FR1	FR0	Frame rate control
N line inversion	0	0	0	1	0	NL4	NL3	NL2	NL1	NL0	Sets N line inversion
Booster Efficiency & Booster Stage(2)	0	0	1	0	0	1	BE1	BE0	PC1	PC0	Booster Efficiency Set
Reserved	0	0	1	X	X	X	X	X	X	X	Do not use

7.2 Interface Timing characteristics

Please refer to the datasheet of ST7579 for more details.

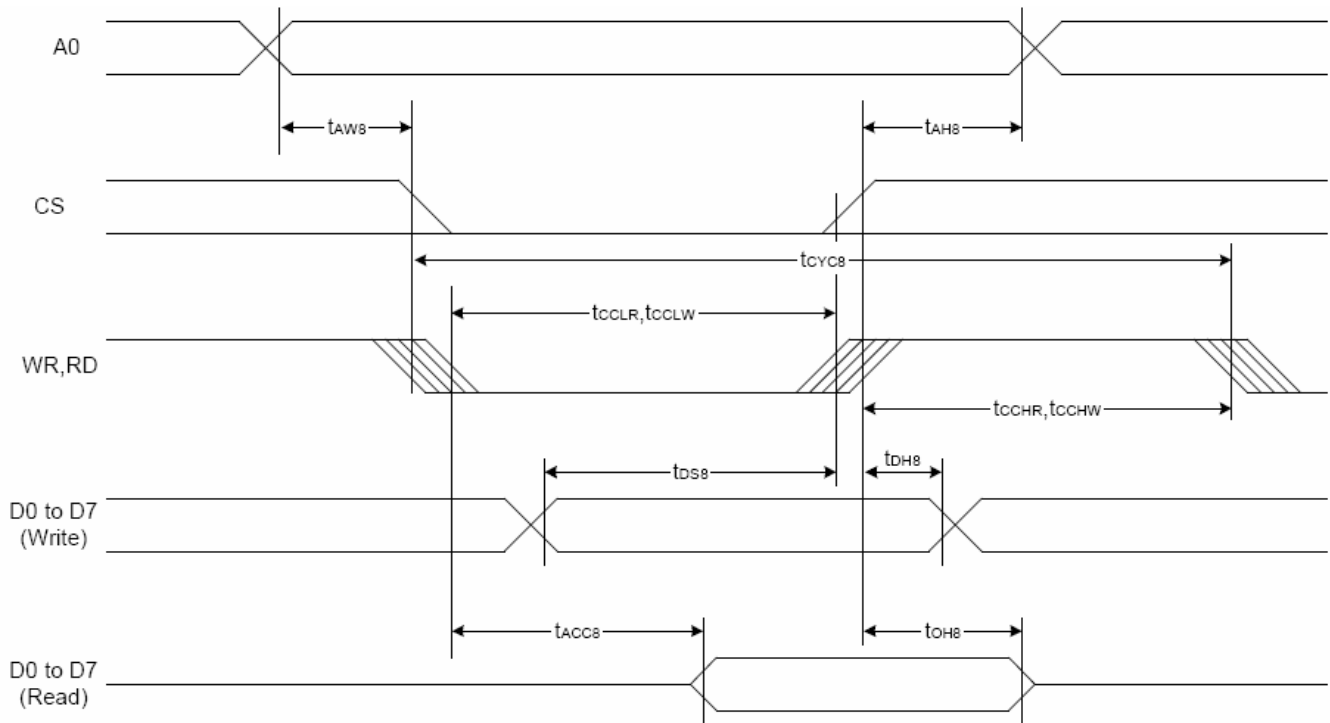

System Bus Read/Write Characteristics (For the 8080 Series MPU)

(VDD=3.0V, Ta=-10°C ~ +60°C)

Item	Signal	Symbol	Condition	Rating		Units
				Min.	Max.	
Address hold time	A0	tAH8		15	—	ns
Address setup time		tAW8		120	—	
System cycle time	WR	tCYC8		450	—	
Enable L pulse width (WRITE)	WR	tCCLW		120	—	
Enable H pulse width (WRITE)		tCCHW		100	—	
Enable L pulse width (READ)	RD	tCCLR		120	—	
Enable H pulse width (READ)		tCCHR		100	—	
WRITE Data setup time	D0 to D7	tDS8		90	—	
WRITE Address hold time		tDH8		15	—	
READ access time		tACC8	CL = 100 pF	—	140	
READ Output disable time		tOH8	CL = 100 pF	10	100	

7.3 Reset Timing

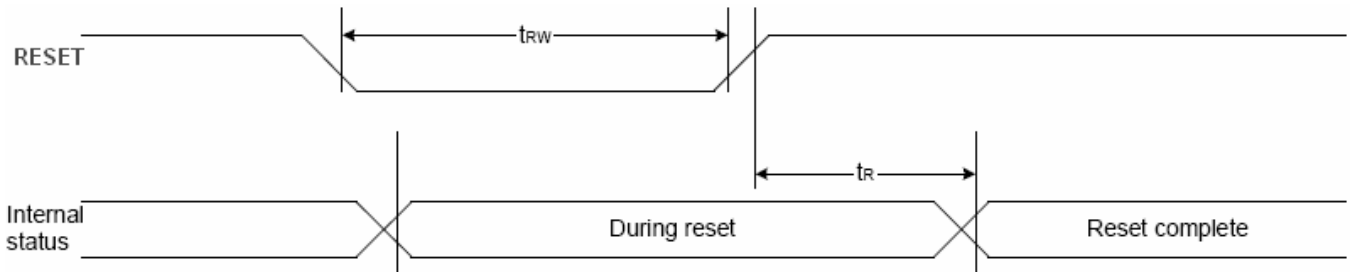

(VDD=3.0V, Ta=-10°C ~ +60°C)

Item	Signal	Symbol	Condition	Rating			Units
				Min.	Typ.	Max.	
Reset time		tR		—	—	2.0	us
Reset "L" pulse width	RESB	tRW		2.0	—	—	us

8 Electrical characteristics

(VSS=0V, Ta=25°C)

Parameter	Symbol	Condition	MIN	TYP	MAX	UNIT
Logic circuit supply voltage	VDD	--	2.4	3.0	3.3	V
Power supply LCD(-)	XV0/V0		6.7	7.0	7.3	
Input voltage for logic circuit	"H" level	V _{IH}	0.8 VDD	VDD	VDD +0.3	
	"L" level	V _{IL}	VSS-0.3	VSS	0.2VDD	
Output voltage for logic circuit	"H" level	V _{OH}	--	VDD	--	
	"L" level	V _{OL}	--	VSS	--	
Logic power supply current (Without backlighting)	I _{DD}	V _{DD} =5.0V	--	(TBD)	--	mA
Used driver IC	ST7579 (COG Type)					

9 Optical Characteristics

(1/16Duty, 1/5Bias, |XV0/V0|=7.0V(Note [9-2]), f=60Hz)

Parameter	Symbol	Ratings			Unit	Measuring Temp.	Remark	
		Min	Type	Max.				
Contrast ratio	Cr ($\theta=0^\circ, \Phi=0^\circ$)	---	5.0	---	---	25°C	Note[9-1,3]	
Response time	Turn on	t _{on}	---	120	---	ms	25°C	Note[9-1,4]
			---	(TBD)	---		0°C	
	Turn off	t _{off}	---	200	---	ms	25°C	
			---	(TBD)	---		0°C	
Viewing angle (Cr≥2)	Up-down	θ_1 ($\Phi=0^\circ$)	---	30	---	deg	25°C	Note[9-1,5]
			---	30	---			
	Left-right	θ_2 ($\theta=0^\circ$)	---	30	---	deg	25°C	
			---	30	---			
Luminance	Y _L ($\theta=0^\circ, \Phi=0^\circ$)	---	---	---	Cd/m ²	25°C	Note[9-1] (I _r =660mA)	
Luminance Uniformity	L _U ($\theta=0^\circ, \Phi=0^\circ$)	70	---	---	%	25°C	Note[9-1,6]	

Note [9-1]: Measuring equipments: DMS-501, PR-705.

Measuring condition:

- After stabilizing and leaving the panel alone at a given temperature for 30 min., the measurement should be executed,
- Measuring surroundings: a stable, windless and dark room,
- Measuring temperature: Ta=25°C,
- 30 min after lighting the back-light.

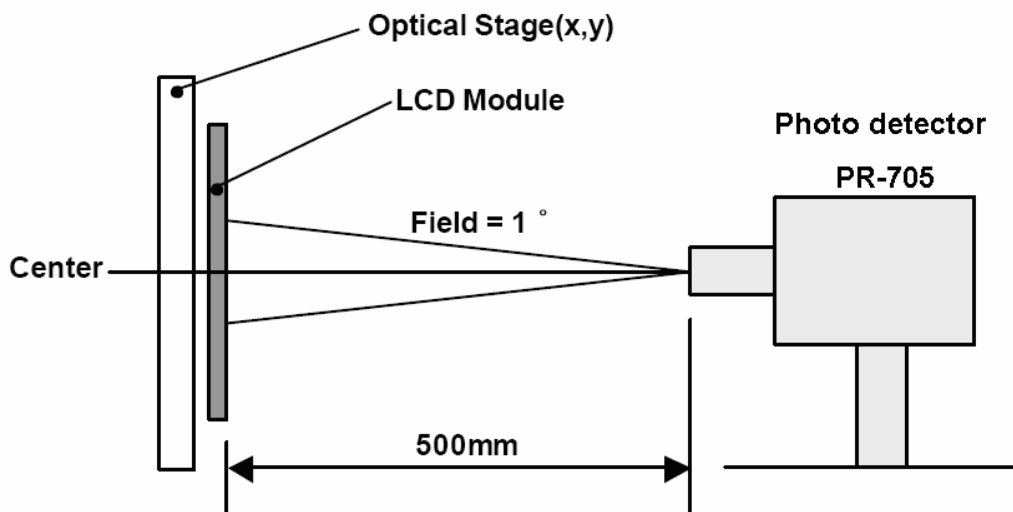

Note [9-2]: The maximum and minimum ratings don't mean the LCD works well in the whole range of V_0 . V_0 must be adjusted to optimize the viewing angle and contrast. Refer to the following definition of drive voltage:

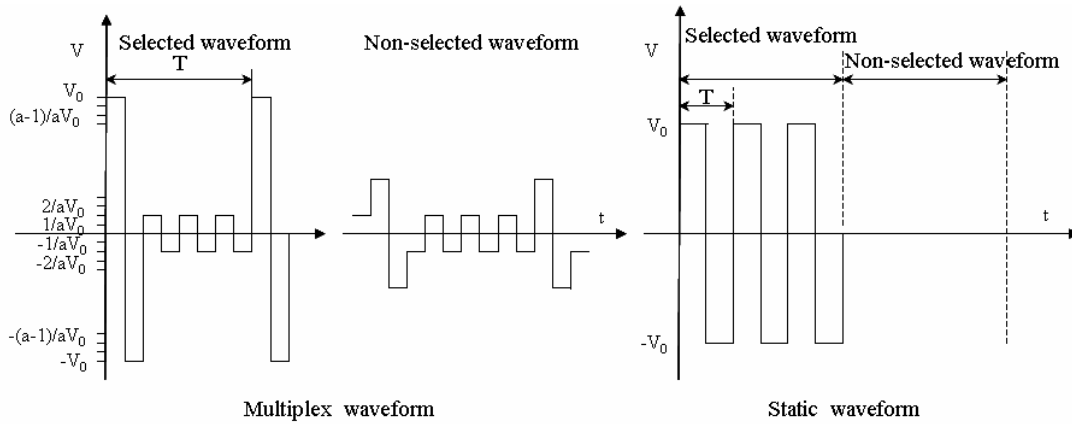

Operating voltage: V_0	Frame frequency: $f=1/T$
Duty: $1/N$	Bias: $1/a$

Note [9-3]: Contrast ratio(CR) is defined as follows:

$$CR = \frac{L_{ON} \text{ (Luminance of the ON segments)}}{L_{OFF} \text{ (Luminance of the OFF segments)}}$$

Note [9-4]: Definition of response time:

Turn on time (rise time): $t_{on} = t_d + t_r$ (The time that the luminance level reaches 90% of the saturation level from 0% when ON signal is applied)

Turn off time (fall time): $t_{off} = t_d + t_r$ (The time that the luminance level reaches 10% of the saturation level from 100% when OFF signal is applied)

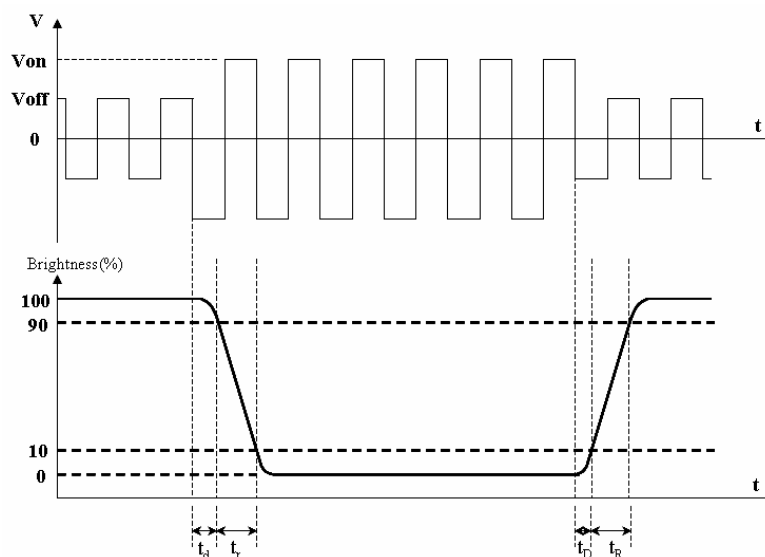

Note [9-5]: Definition of viewing direction

Refer to the picture below marked by θ and Φ

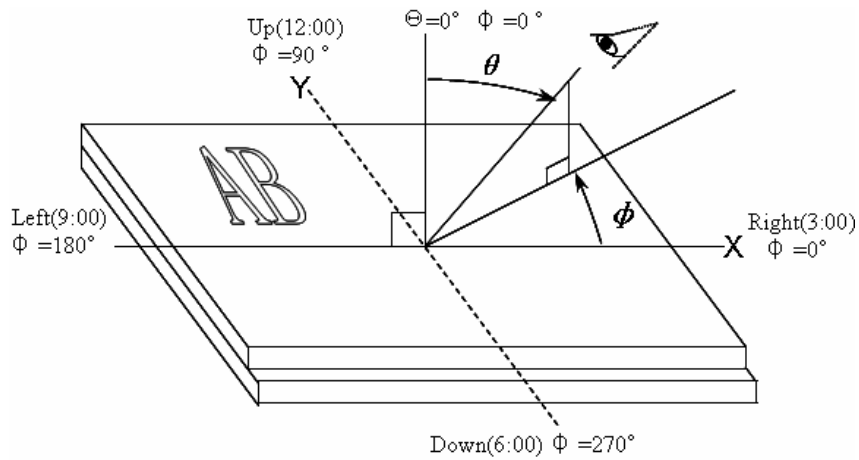

Definition of viewing angle

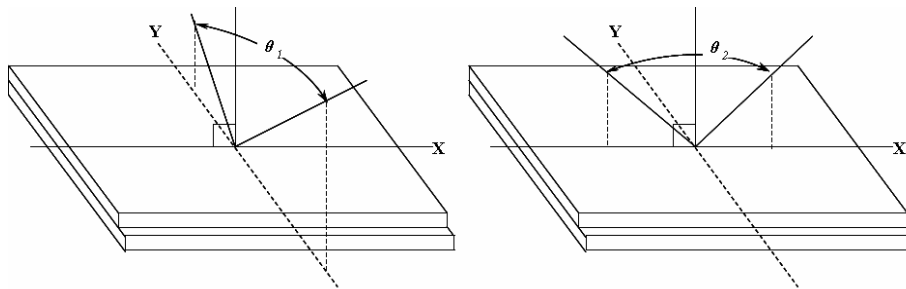

θ_1 ——range of viewing angle from up to down; θ_2 ——range of viewing angle from left to right.

Note [10-6]: The definition of luminance uniformity:

The luminance uniformity is calculated by using following formula.

$$\text{Luminance uniformity (Lu)} = \frac{\text{Minimum luminance from } \square \text{ to } \square}{\text{Maximum luminance from } \square \text{ to } \square}$$

The luminance is measured at near the 9 points shown below.

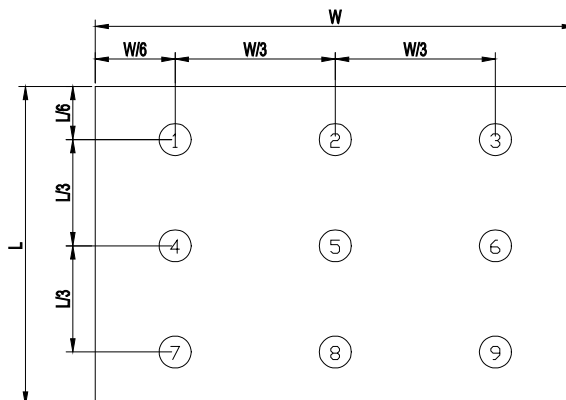

10 Reliability

10.1 Content of Reliability Test

No.	Test Item	Test condition	Remark	Criterion
1	High Temperature Storage	Ta=70°C, 120H		Remark1 Remark2 Remark3 Remark4
2	Low Temperature Storage	Ta=-20°C, 120H	Note[10-1]	
3	High Temperature Operation	Ta=60°C, 120H		
4	Low Temperature Operation	Ta=-10°C, 120H	Note[10-1]	
5	High Temperature & High Humidity Operation	Ta=60°C, 90%RH, 120H	Note[10-1]	
6	Temperature Cycle Test (Non-Operating)	-20 °C↔+25 °C↔+70 °C,100 Cycles 30min 5min 30min	Note[10-1]	
7	Vibration Test	Frequency: 10 ~150 Hz, Stroke: 1.5mm Sweep time: 11 min Test Period: 6 cycles for each direction of X,Y,Z,120 min every direction	Note[10-2]	Remark1 Remark5 Remark6
8	Shock Test	Waveform : Half Sinusoidal Wave Shock Level:50 G, Pulse Width:11 ms, Direction: ±X, ±Y, ±Z, Cycle:3 times	Note[10-2]	

Note [10-1]: No dew condensation to be observed.

Note [10-2]: Vibration test will be conducted to the product itself without putting it in a container.

Note [10-3]: The test sample is inspected after 2 hours or more storing at room temperature and room humidity after each test item is finished.

Note [10-4]:The criteria refer to 10.2.

10.2 Inspection of criteria

Remark NO.	Content
1	Function test is OK. Missing Segment, shorts, unclear segment, non-display, display abnormally, liquid crystal leak are unallowable.
2	After testing, cosmetic defects should not happen, no low temperature bubbles, seal loose and fall, frame rainbow, ACF bubble growing are unallowable in the appearance test.
3	Total current consumption should not be over 10% of initial value.
4	After tests, the contrast ratio must be larger than 70% of its value before.
5	No glass crack, chipped glass, end seal loose frame crack and so on.
6	No structure looseness.

11 Package

TBD

12 Quality level

Examination or Test	At T _a =25°C (Unless otherwise stated)	Inspection				
		Min	Max	Unit	IL	AQL
External Visual Inspection	Under normal illumination and eyesight condition, the distance between eyes and LCD is 25cm.	Refer to appendix A			II	Major 1.0 Minor 2.5
Display Defects	Under normal illumination and eyesight condition, display on inspection.	Refer to appendix B			II	Major 1.0 Minor 2.5
Note: Major defects: Open segment or common, Short, Serious damages, Leakage Miner defects: Others Sampling standard conforms to GB2828						

13 Precautions for Use of LCD Modules

13.1 Handling Precautions

- 13.1.1 The display panel is made of glass. Do not subject it to a mechanical shock by dropping it from a high place, etc.
- 13.1.2 Liquid in LCD is hazardous substance, if the display panel is damaged and the liquid crystal substance inside it leaks out, be sure not to get any in your mouth, if the substance comes into contact with your skin or clothes, thoroughly and promptly wash it off using soap and water.
- 13.1.3 Do not apply excessive force to the display surface or the adjoining areas since this may cause the color tone to vary.
- 13.1.4 Don't touch, push or rub the exposed polarizer covering the display surface of the LCD module with anything harder than an HB pencil lead, the polarizer is soft and easily scratched, handle it carefully.
- 13.1.5 Don't put or attach anything on the display area to avoid leaving any marks on.
- 13.1.6 If the display surface is contaminated or becomes dusty, breathe on the surface and gently wipe it with a soft dry cloth. do not scrub hard to avoid damage the surface. If still not completely clear, moisten cloth with one of the following solvents:
- Isopropyl alcohol
 - Ethyl alcohol
- Solvents other than those mentioned above may damage the polarizer. Especially, do not use the following:
- Water
 - Ketone
 - Aromatic solvents
- 13.1.7 Do not attempt to disassemble the LCD Module.
- 13.1.8 If the logic circuit power is off, do not apply the input signals.
- 13.1.9 Avoid using the same display pattern long time (continuous ON segment).Software must be prepared so that the pattern will be changed

- 13.1.10 To prevent destruction of the elements by static electricity, be careful to maintain an optimum work environment.
- Be sure to ground the body and electric appliances when handling the LCD Modules. It is preferable to use conductive mat on table and wear cotton clothes or conductive processed fiber. Synthetic fiber is not recommended.
 - Tools required for assembly, such as soldering irons, must be properly ground.
 - To reduce the amount of static electricity generated, do not conduct assembly and other work under dry conditions.
 - The LCD Module is coated with a film to protect the display surface. Be careful and slow when peeling off this protective film since static electricity may be generated. It is recommended to use ionic fan or machine when operating. It is recommended to remove the protection foil slowly (> 3 sec.).
 - It is preferable to wear gloves etc, to avoid damaging the LCD. Please do not touch electrodes with bare hands or avoid any other contamination.

13.2 Storage precautions

- 13.2.1 When storing the LCD modules, avoid exposure to direct sunlight or to the light of fluorescent lamps.
- 13.2.2 The LCD modules should be stored under the storage temperature range. If the LCD modules will be stored for a long time, the recommend condition is:
- Temperature : 5°C ~ 40°C
- Relatively humidity: ≤80%
- 13.2.3 The LCD modules should be stored in a clean environment or room, free from acid, alkali and harmful gas.
- 13.2.4 Store the module in anti-static electricity container and without any physical load.

13.3 Transportation precautions

The LCD modules should be no falling and violent shocking during transportation, and also should avoid excessive press, water, damp and sunshine.

13.4 Soldering

- 13.4.1 Use the high quality solders, only solder the I/O terminals.
- 13.4.2 No higher than 280°C and time less than 3-4 second during soldering.
- 13.4.3 Rewiring: no more than 3 times.
- 13.4.4 When you remove connector or cable soldered to I/O terminals, please confirm that solder is fully melted. If you remove by force, electrodes at I/O terminals may be damaged (or stripped off). It is recommended to use solder suction machine.

14. LCD Module Part Numbering System

TM	9616	A	G	H	W	G	N	A
①	②	③	④	⑤	⑥	⑦	⑧	⑨

NO.	Explanation	
①	TIANMA module indicating	
②	Module type: 96 columns × 16 rows	
③	TIANMA module series: A series	
④	LCD type	
	G	Negative, FSTN
⑤	Backlight type	
	H	Transmissive, without LED
⑥	Temperature range	
	W	Wide temperature
⑦	Technology	
	G	COG
⑧	The color of backlight	
	N	Without a backlight unit
⑨	Module type	
	A	Basic function, without the DC/DC and Temperature Compensation circuit

Appendix A
Inspection items and criteria for appearance defects

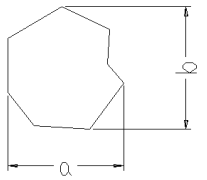
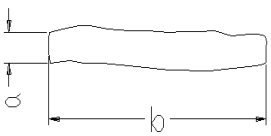
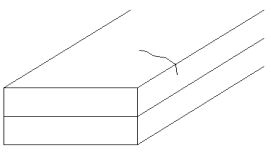
Items	Contents	Criteria	
Protective Glue		No clear defects	
Cover Tape		Covering all of the chip and no clear crimple	
Leakage		Not permitted	
Rainbow		According to the limit specimen	
Polarizer	Wrong polarizer attachment	Not permitted	
	Bubble between polarizer and glass	Not counted	Max. 3 defects allowed
		$\phi < 0.3\text{mm}$	$0.3\text{mm} \leq \phi \leq 0.5\text{mm}$
Scratches of polarizer	According to the limit specimen		
Black spot (in viewing area)		Not counted	Max. 3 spots allowed
		$X < 0.20\text{mm}$	$0.20\text{mm} \leq X \leq 0.5\text{mm}$
		$X = (a+b)/2$	
Black line (in viewing area)		Not counted	Max. 3 lines allowed
		$a < 0.02\text{mm}$	$0.02\text{mm} \leq a \leq 0.05\text{mm}$ $b \leq 2.0\text{mm}$
Progressive cracks		Not permitted	

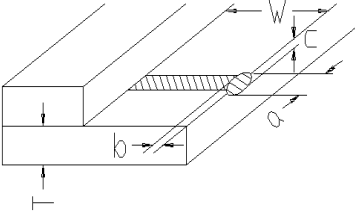
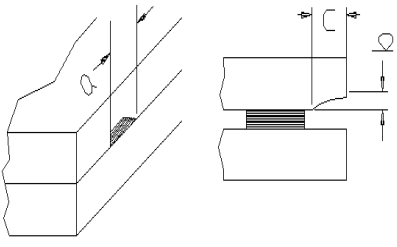
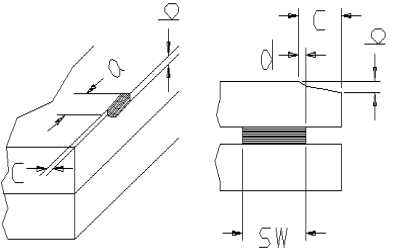
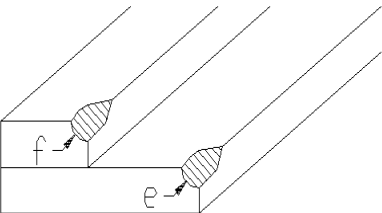
Item	Contents	Criteria							
Glass Cracks	Cracks on pads 	a	b	c	Max. 2 Cracks allowed	Max. 5 cracks allowed			
		$\leq 3\text{mm}$	$\leq W/5$	$\leq T/2$					
		$\leq 2\text{mm}$	$\leq W/5$	$T/2 < C < T$					
	Cracks on contact side 	a	b		Max. 2 cracks allowed				
		$\leq 3\text{mm}$	$\leq T/2$						
		$\leq 2\text{mm}$	$T/2 < b < T$						
		C shall be not reach the seal area							
	Cracks on non-contact side 	a	b		Max. 2 cracks allowed				
		$\leq 3\text{mm}$	$\leq T/2$						
		$\leq 2\text{mm}$	$T/2 < b < T$						
	$C \leq 0.5\text{mm}$								
	$d \leq SW/3$								
Corner cracks 	$e < 2.0\text{mm}^2$ $f < 2.0\text{mm}^2$			Max. 3 cracks allowed					

Appendix B
Inspection items and criteria for display defects

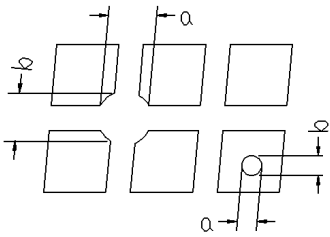
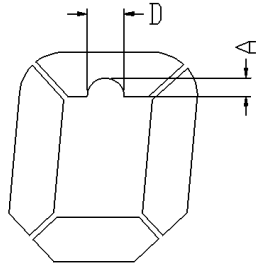
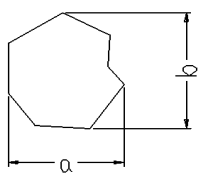
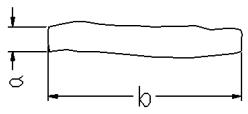
Items	Contents	Criterion		
Open segment or open common		Not permitted		
Short		Not permitted		
Wrong viewing angle		Not permitted		
Contrast ratio uneven		According to the limit specimen		
Crosstalk		According to the limit specimen		
Pin holes and cracks in segment (DOT)		Not counted	Max.3 dots allowed	Max.3 dots allowed
		$X < 0.1\text{mm}$	$0.1\text{mm} \leq X \leq 0.2\text{mm}$	
		$X = (a+b)/2$		
		Not counted	Max.2 dots allowed	
$A < 0.1\text{mm}$		$0.1\text{mm} \leq A \leq 0.2\text{mm}$ $D < 0.25\text{mm}$		
Black spot (in viewing area)		Not counted	Max.3 spots allowed	Max.3 spots (lines) allowed
		$X < 0.1\text{mm}$	$0.1\text{mm} \leq X \leq 0.2\text{mm}$	
		$X = (a+b)/2$		
Black line (in viewing area)		Not counted	Max.3 lines allowed	
		$a < 0.02\text{mm}$	$0.02\text{mm} \leq a \leq 0.05\text{mm}$ $b \leq 0.5\text{mm}$	

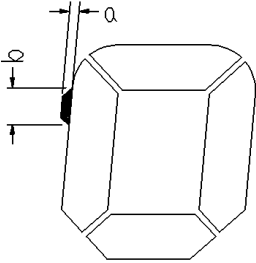
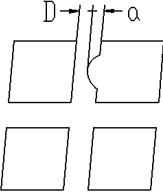
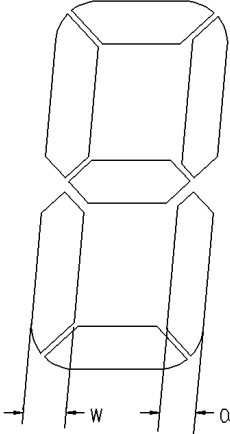
Items	Content	Criterion		
Transformation of segment		Not counted	Max. 2 defects allowed	Max.3 defects allowed
		$x < 0.1\text{mm}$	$0.1\text{mm} \leq x \leq 0.2\text{mm}$	
		$x = (a+b)/2$		
		Not counted	Max. 1 defects allowed	
		$a < 0.1\text{mm}$	$0.1\text{mm} \leq a \leq 0.2\text{mm}$ $D > 0$	
		Max.2 defects allowed $0.8W \leq a \leq 1.2W$ $a = \text{measured value of width}$ $W = \text{nominal value of width}$		