

Supply Voltage: 0.9 to 3.6 V

- One-cell mode supports 0.9–1.8 V operation
- Two-cell mode supports 1.8–3.6 V operation
- Built-in dc-dc converter with 1.8–3.3 V output (65 mW max) for use in one-cell mode; can supply external devices
- Typical sleep mode current < 0.1 μ A; retains state and RAM-contents over full supply range; fast wakeup
- 2 built-in brown-out detectors cover sleep and active modes

10-Bit Analog to Digital Converter

- Up to 300 ksp/s
- Up to 23 external inputs
- External pin or internal VREF (no external capacitor required)
- Built-in temperature sensor
- External conversion start input option
- Autonomous Burst Mode with 16-bit automatic averaging accumulator

Two Comparators

- Programmable hysteresis and response time
- Configurable as interrupt or reset source
- Low current (< 0.5 μ A)
- Up to 23 Capacitive Touch Sense inputs

Memory

- 4352 bytes internal data RAM (256 + 4K)
- 64 kB bytes Flash; In-system programmable in 1024-byte sectors; Full read/write/erase functionality over the entire supply range
- External memory interface (multiplexed address/data)

On-Chip Debug

- On-chip debug circuitry facilitates full speed, non-intrusive in-system debug (no emulator required)

High-Speed 8051 μ C Core

- Pipe-lined instruction architecture; executes 70% of instructions in 1 or 2 system clocks
- 25 MIPS peak throughput with 25 MHz clock
- Expanded interrupt handler

Digital Peripherals

- 24 port I/O; All 5 V tolerant with programmable drive strength
- Hardware enhanced UART, SPI and SMBus™ serial ports available concurrently
- Low power 32-bit smaRTClock (0.5 μ A) operates down to 0.9V
- Four general purpose 16-bit counter/timers
- 16-bit programmable counter array (PCA) with six capture/compare modules and watchdog timer:
 - 8, 9, 10, 11, or 16-bit PWM
 - Rising/falling edge capture
 - Frequency output
 - Software timer

Clock Sources

- Precision internal oscillators: 24.5 MHz with \pm 2% accuracy supports UART operation; spread-spectrum mode for reduced EMI
- Low power internal oscillator: 20 MHz
- External oscillator: Crystal, RC, C, CMOS clock
- smaRTClock oscillator: 32.768 kHz crystal or self-oscillate
- Can switch between clock sources on-the-fly; useful in power saving modes

Ultra-Small Package Options

- 32-pin QFN (5x5 mm)
- 32-pin LQFP (7x7 mm)

Temperature Range: –40 to +85 °C

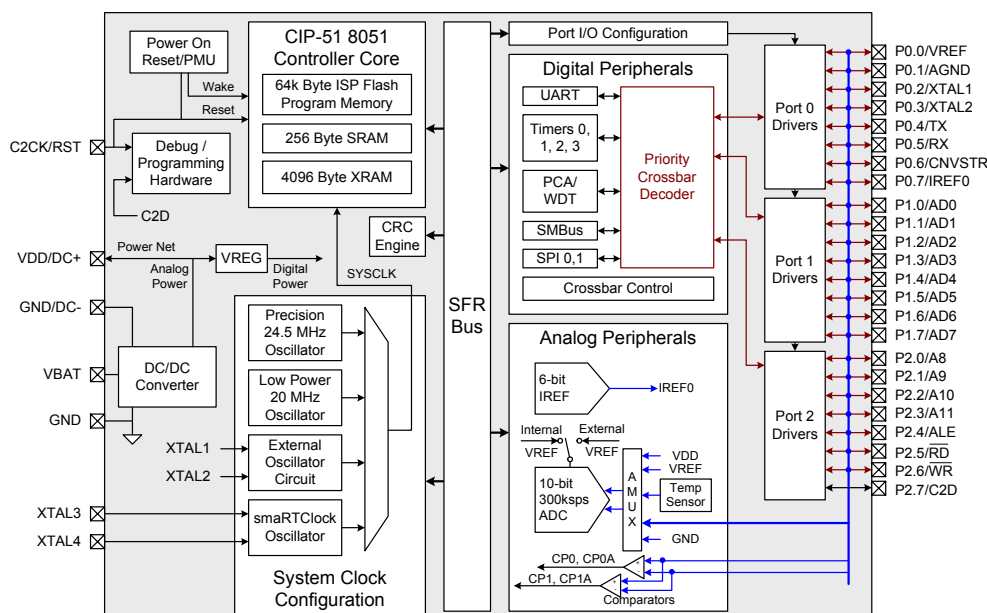

Selected Electrical Specifications

(At 25 C°)

Parameter	Conditions	Min	Typ	Max	Units
Supply Input Voltage two-cell mode one-cell mode	DC-DC converter disabled	1.8	—	3.6	V
	DC-DC converter enabled	0.9	—	1.8	V
DC-DC Boost Converter Output Power (V _{OUT} = 1.8–3.3 V)	Includes on and off-chip current	—	—	65	mW
Supply Current with CPU Active	VDD = 1.8–3.6 V Clock = 24.5 MHz (±2% internal precision oscillator)	—	4.1	—	mA
Supply Current (shutdown) (V _{BAT} = 1.8 V)	Sleep mode; smartClock off	—	50	—	nA
	Sleep mode; smartClock running	—	0.6	—	µA
Clock Frequency Range		DC	—	25	MHz
Wakeup Time	two-cell mode	—	2	—	µs
	one-cell mode	—	10	—	µs
Internal Oscillator					
Frequency	Precision oscillator	24	24.5	25	MHz
	Low power oscillator	18	20	22	MHz
A/D Converter					
Resolution				10	bits
Throughput Rate				300	ksp/s

Package Information: 32-Pin QFN

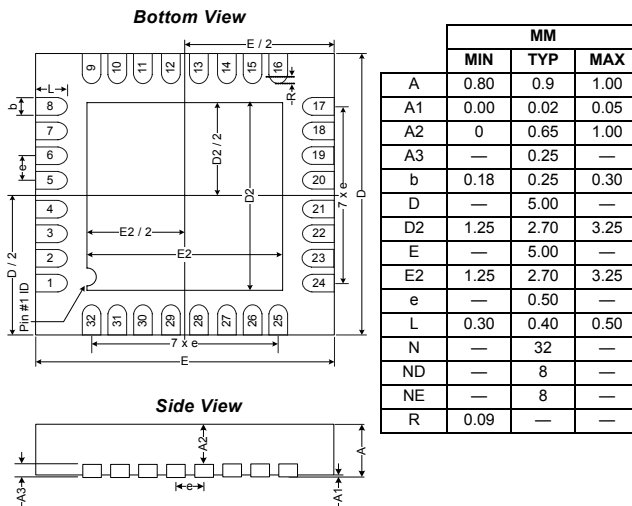

Package Information: 32-Pin LQFP

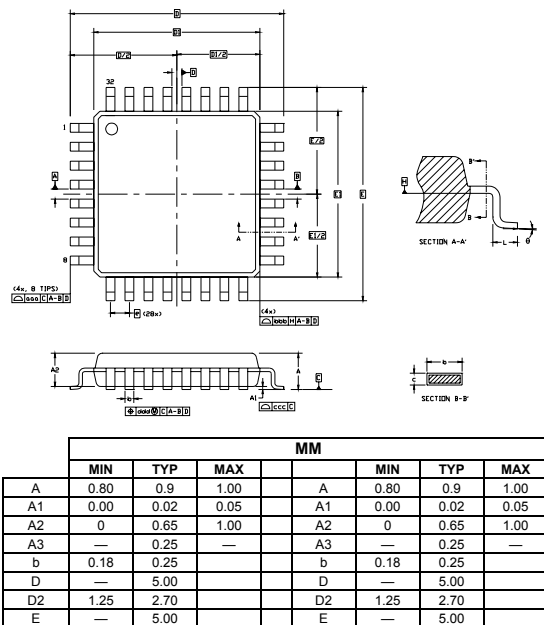

C8051F9xx Product Family

Device Part #	Package	Flash Size	RAM Size
C8051F930-GQ	32-pin LQFP	64 kB	4 kB
C8051F930-GM	32-pin QFN	64 kB	4 kB
C8051F931-GM	24-pin QFN	64 kB	4 kB
C8051F920-GQ	32-pin LQFP	32 kB	4 kB
C8051F920-GM	32-pin QFN	32 kB	4 kB
C8051F921-GM	24-pin QFN	32 kB	4 kB