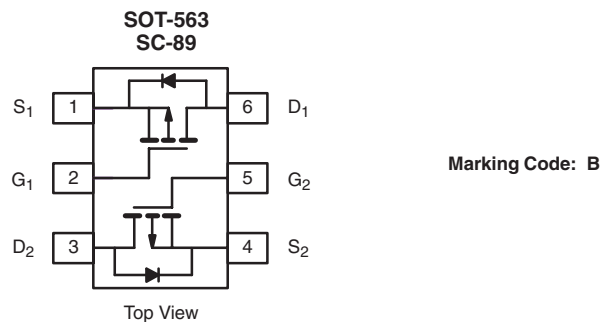

Dual P-Channel 20-V (D-S) MOSFET

PRODUCT SUMMARY		
V_{DS} (V)	$R_{DS(on)}$ (Ω)	I_D (mA)
- 20	1.2 at $V_{GS} = - 4.5$ V	- 350
	1.6 at $V_{GS} = - 2.5$ V	- 300
	2.7 at $V_{GS} = - 1.8$ V	- 150

FEATURES

- Halogen-free Option Available
- TrenchFET® Power MOSFET: 1.8 V Rated
- Very Small Footprint
- High-Side Switching
- Low On-Resistance: 1.2 Ω
- Low Threshold: 0.8 V (typ.)
- Fast Switching Speed: 14 ns
- 1.8 V Operation
- Gate-Source ESD Protected: 2000 V

RoHS
COMPLIANT

Ordering Information: Si1023X-T1-E3 (Lead (Pb)-free)
Si1023X-T1-GE3 (Lead (Pb)-free and Halogen-free)

BENEFITS

- Ease in Driving Switches
- Low Offset (Error) Voltage
- Low-Voltage Operation
- High-Speed Circuits
- Low Battery Voltage Operation

APPLICATIONS

- Drivers: Relays, Solenoids, Lamps, Hammers, Displays, Memories
- Battery Operated Systems
- Power Supply Converter Circuits
- Load/Power Switching Cell Phones, Pagers

ABSOLUTE MAXIMUM RATINGS $T_A = 25$ °C, unless otherwise noted				
Parameter	Symbol	5 s	Steady State	Unit
Drain-Source Voltage	V_{DS}	- 20		V
Gate-Source Voltage	V_{GS}	± 6		
Continuous Drain Current ($T_J = 150$ °C) ^a	I_D	$T_A = 25$ °C	- 390	- 370
		$T_A = 85$ °C	- 280	- 265
Pulsed Drain Current ^b	I_{DM}	- 650		mA
Continuous Source Current (Diode Conduction) ^a	I_S	- 450	- 380	
Maximum Power Dissipation ^a	P_D	$T_A = 25$ °C	280	250
		$T_A = 85$ °C	145	130
Operating Junction and Storage Temperature Range	T_J, T_{stg}	- 55 to 150		°C
Gate-Source ESD Rating (HBM, Method 3015)	ESD	2000		V

Notes:

- a. Surface Mounted on FR4 board.
b. Pulse width limited by maximum junction temperature.

SPECIFICATIONS $T_J = 25\text{ }^\circ\text{C}$, unless otherwise noted						
Parameter	Symbol	Test Conditions	Min.	Typ.	Max.	Unit
Static						
Gate Threshold Voltage	$V_{GS(th)}$	$V_{DS} = V_{GS}$, $I_D = -250\text{ }\mu\text{A}$	-0.45			V
Gate-Body Leakage	I_{GSS}	$V_{DS} = 0\text{ V}$, $V_{GS} = \pm 4.5\text{ V}$		± 1	± 2	μA
Zero Gate Voltage Drain Current	I_{DSS}	$V_{DS} = -16\text{ V}$, $V_{GS} = 0\text{ V}$		-0.3	-100	nA
		$V_{DS} = -16\text{ V}$, $V_{GS} = 0\text{ V}$, $T_J = 85\text{ }^\circ\text{C}$			-5	μA
On-State Drain Current ^a	$I_{D(on)}$	$V_{DS} = -5\text{ V}$, $V_{GS} = -4.5\text{ V}$	-700			mA
Drain-Source On-State Resistance ^a	$R_{DS(on)}$	$V_{GS} = -4.5\text{ V}$, $I_D = -350\text{ mA}$		0.8	1.2	Ω
		$V_{GS} = -2.5\text{ V}$, $I_D = -300\text{ mA}$		1.2	1.6	
		$V_{GS} = -1.8\text{ V}$, $I_D = -150\text{ mA}$		1.8	2.7	
Forward Transconductance ^a	g_{fs}	$V_{DS} = -10\text{ V}$, $I_D = -250\text{ mA}$		0.4		S
Diode Forward Voltage ^a	V_{SD}	$I_S = -150\text{ mA}$, $V_{GS} = 0\text{ V}$		-0.8	-1.2	V
Dynamic^b						
Total Gate Charge	Q_g	$V_{DS} = -10\text{ V}$, $V_{GS} = -4.5\text{ V}$, $I_D = -250\text{ mA}$		1500		μC
Gate-Source Charge	Q_{gs}			150		
Gate-Drain Charge	Q_{gd}			450		
Turn-On Time	$t_{d(on)}$	$V_{DD} = -10\text{ V}$, $R_L = 47\text{ }\Omega$ $I_D \cong -200\text{ mA}$, $V_{GEN} = -4.5\text{ V}$, $R_G = 10\text{ }\Omega$		14		ns
Turn-Off Time	$t_{d(off)}$			46		

Notes:

- a. Pulse test; pulse width $\leq 300\text{ }\mu\text{s}$, duty cycle $\leq 2\%$.
 b. Guaranteed by design, not subject to production testing.

Stresses beyond those listed under "Absolute Maximum Ratings" may cause permanent damage to the device. These are stress ratings only, and functional operation of the device at these or any other conditions beyond those indicated in the operational sections of the specifications is not implied. Exposure to absolute maximum rating conditions for extended periods may affect device reliability.

TYPICAL CHARACTERISTICS $T_A = 25\text{ }^\circ\text{C}$, unless otherwise noted

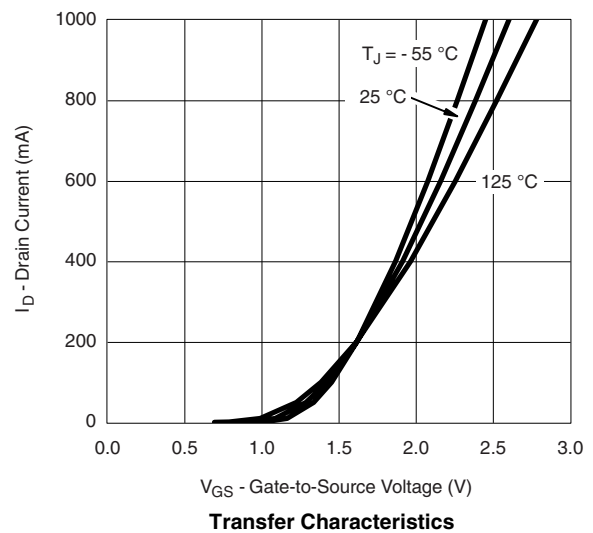
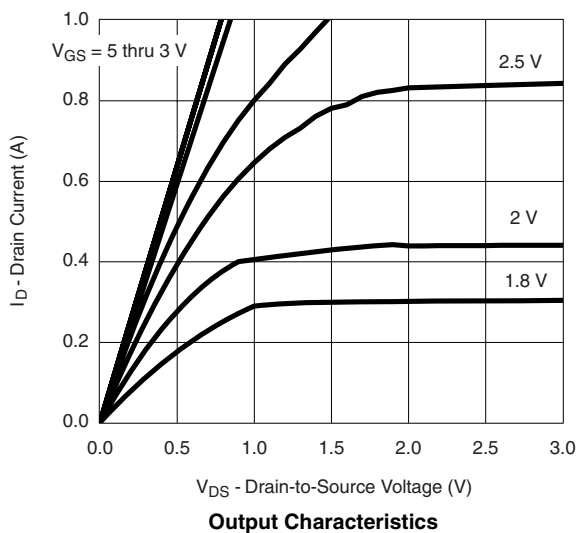

TYPICAL CHARACTERISTICS $T_A = 25\text{ }^\circ\text{C}$, unless otherwise noted

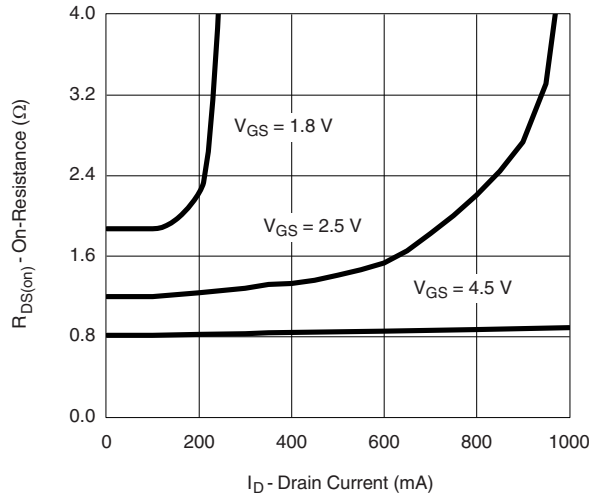

On-Resistance vs. Drain Current

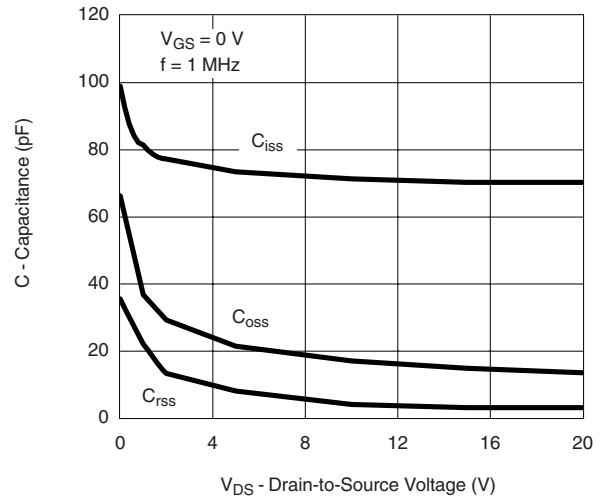

Capacitance

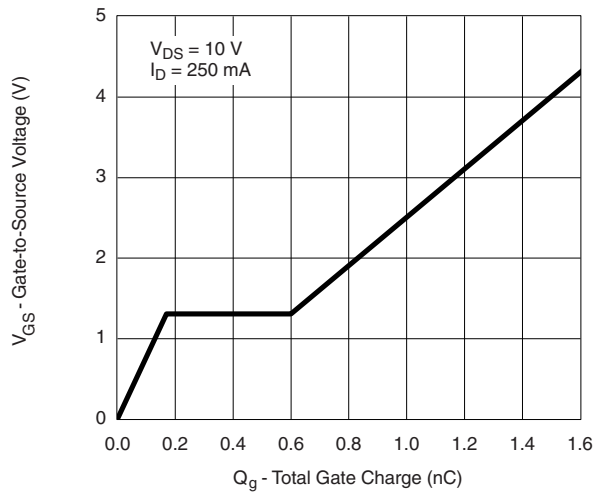

Gate Charge

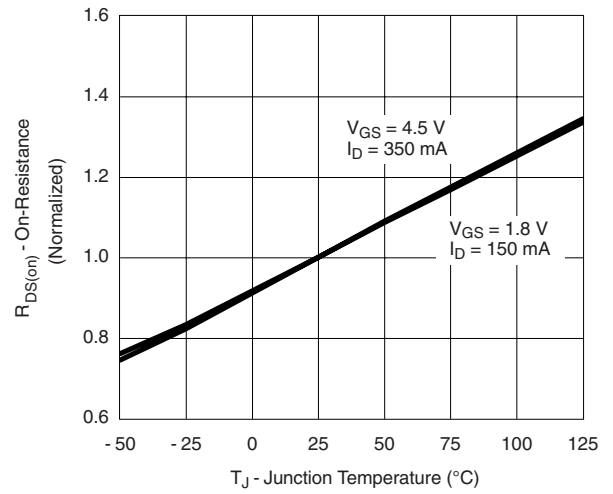

On-Resistance vs. Junction Temperature

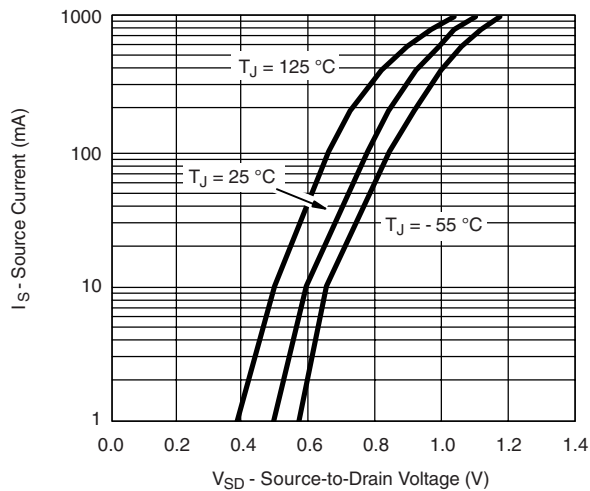

Source-Drain Diode Forward Voltage

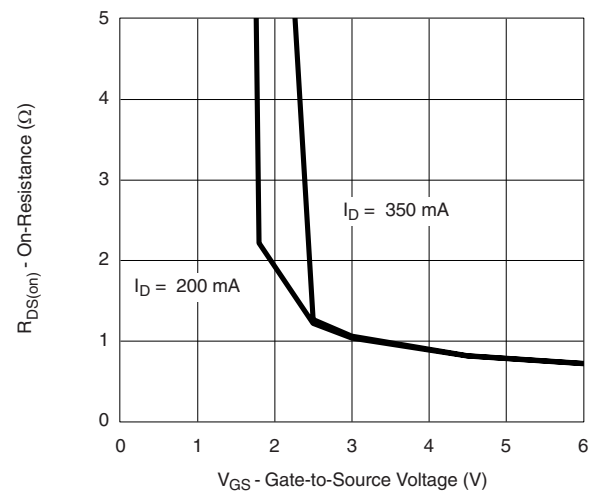

On-Resistance vs. Gate-to-Source Voltage

TYPICAL CHARACTERISTICS $T_A = 25\text{ }^\circ\text{C}$, unless otherwise noted

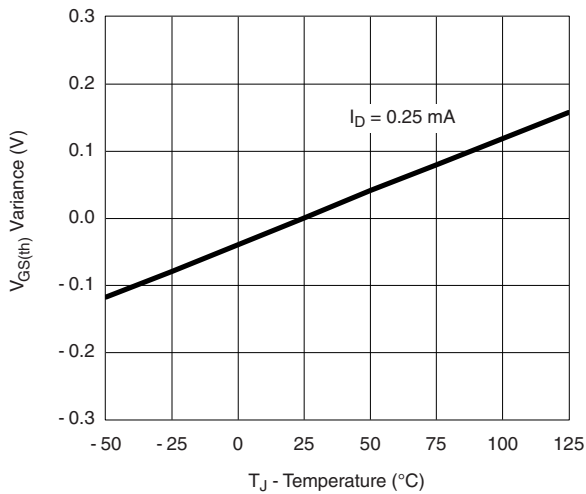

Threshold Voltage Variance vs. Temperature

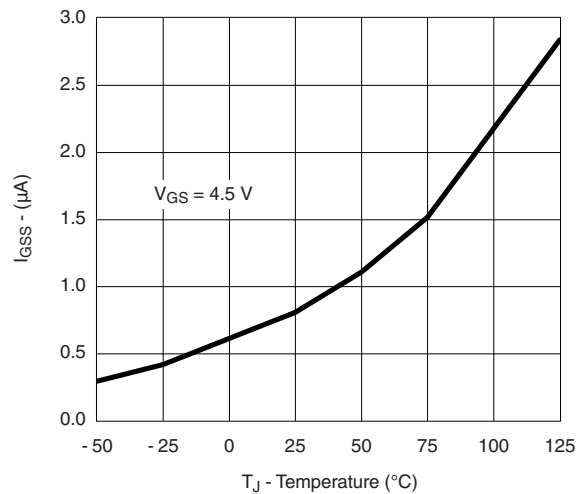

I_{GSS} vs. Temperature

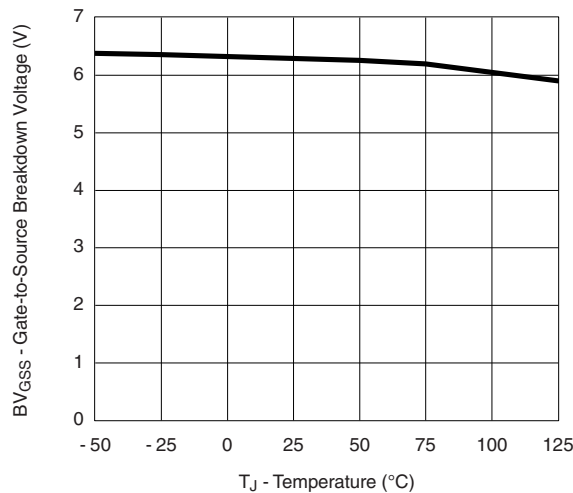

BV_{GSS} vs. Temperature

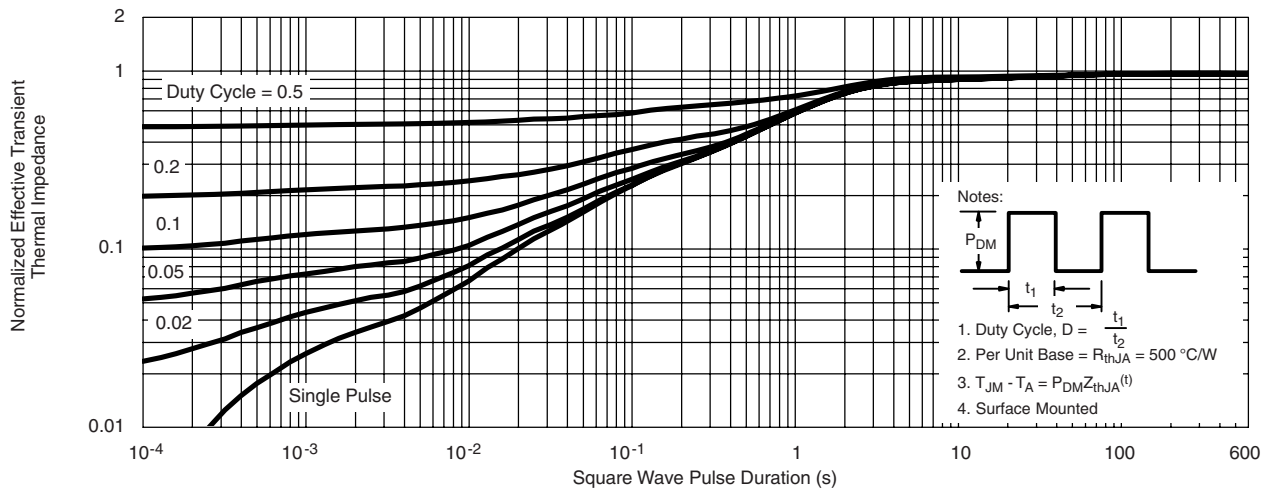

Normalized Thermal Transient Impedance, Junction-to-Ambient

Vishay Siliconix maintains worldwide manufacturing capability. Products may be manufactured at one of several qualified locations. Reliability data for Silicon Technology and Package Reliability represent a composite of all qualified locations. For related documents such as package/tape drawings, part marking, and reliability data, see <http://www.vishay.com/ppg?71169>.



Notice

Specifications of the products displayed herein are subject to change without notice. Vishay Intertechnology, Inc., or anyone on its behalf, assumes no responsibility or liability for any errors or inaccuracies.

Information contained herein is intended to provide a product description only. No license, express or implied, by estoppel or otherwise, to any intellectual property rights is granted by this document. Except as provided in Vishay's terms and conditions of sale for such products, Vishay assumes no liability whatsoever, and disclaims any express or implied warranty, relating to sale and/or use of Vishay products including liability or warranties relating to fitness for a particular purpose, merchantability, or infringement of any patent, copyright, or other intellectual property right.

The products shown herein are not designed for use in medical, life-saving, or life-sustaining applications. Customers using or selling these products for use in such applications do so at their own risk and agree to fully indemnify Vishay for any damages resulting from such improper use or sale.