



Single

Dual

APPLICATIONS

Wireless Network
Telecom/Datacom
Industry Control System
Distributed Power Architectures
Semiconductor Equipment

FEATURES

- 100 WATTS MAXIMUM OUTPUT POWER
- SINGLE : OUTPUT CURRENT UP TO 25A
DUAL : TOTAL OUTPUT POWER UP TO 100W
- COMPACT 2.40 X 2.28 X 0.50 INCH PACKAGE
- HIGH EFFICIENCY UP TO 90%
- INPUT RANGE FROM 36VDC TO 75VDC
- FIXED SWITCHING FREQUENCY(300KHz)
- HALT TESTED
- INDUSTRY STANDARD FOOTPRINT
- ADJUSTABLE OUTPUT VOLTAGE
- INPUT TO OUTPUT ISOLATION (BASIC INSULATION)
- CE MARK MEETS 2006/95/EC, 93/68/EEC AND 2004/108/EC
- SINGLE :UL60950-1, EN60950-1 AND IEC60950-1 LICENSED
- DUAL:DESIGN MEET UL60950-1, EN60950-1 AND IEC60950-1
- ISO9001 CERTIFIED MANUFACTURING FACILITIES
- COMPLIANT TO RoHS EU DIRECTIVE 2002/95/EC

OPTIONS

Remote On/Off, Pin length

DESCRIPTION

HEC100-SERIES DC/DC converters provide up to 100 watts of output power in an industry standard half-brick package and footprint. All models feature a wide input range, trimmable output voltage and a 25A current rating.

TECHNICAL SPECIFICATION All specifications are typical at nominal input, full load and 25°C otherwise noted

OUTPUT SPECIFICATIONS			
Output power	Total output power	100 Watts max.	
Voltage accuracy	Full load and nominal Vin	± 1.5%	
	Single	± 1.0%	
Minimum load		0%	
Voltage adjustability	Single (Note 5)	+ 10% , -20%	
	Dual for Each output	± 10%	
Line regulation	LL to HL at FL	See table	
Load regulation	Single(No Load to Full Load)	See table	
	Dual(No Load to Full Load)		
Remote sense (Note 5)	Single	10% of Vout	
Ripple and noise 20MHz bandwidth (Note 6)		100mVp-p	
Temperature coefficient		±0.02% / °C, max.	
Transient response recovery time	25% load step change	200µS	
Over voltage protection threshold	Single (Hiccup)	115% ~ 130% of Vout	
	Dual		
	2.5V	3.0V	
	3.3V	3.9V	
	5V	6.2V	
Over current protection threshold	Single	110% ~ 140% of Iout Rated	
	Dual	110% ~ 120% of Iout Rated	
Short circuit protection		Hiccup, automatics recovery	
GENERAL SPECIFICATIONS			
Efficiency		See table	
Isolation voltage	Input to Output	1600 VDC, min.	
	Input to Case	1000 VDC, min.	
	Output to Case	1000 VDC, min.	
Isolation resistance	Single	10 ⁷ ohms,min.	
	Dual	10 ⁹ ohms,min.	
Isolation capacitance	Single	2500pF,max.	
	Dual	1500pF,max.	
Switching frequency		300KHz,typ.	
Approvals and standard	Single	IEC60950-1, UL60950-1, EN60950-1	
Design meets standard	Dual	IEC60950-1, UL60950-1, EN60950-1	
Case material	Dual	Non-conductive black plastic	
Base material		Aluminum base-plate	
Potting material	Dual	Silicon (UL94-V0)	
Weight	Single	65g (2.29oz)	
	Dual	105g (3.70oz)	
MTBF (Note 1)	BELLCORE TR-NWT-000332	Single	2.000 x 10 ⁶ hrs
		Dual	1.004 x 10 ⁶ hrs
	MIL-HDBK-217F	Single	2.144 x 10 ⁵ hrs
		Dual	7.740 x 10 ⁴ hrs

INPUT SPECIFICATIONS		
Input voltage range		36 – 75VDC
Input filter		L-C type
Input surge voltage	100mS max. (Single)	100VDC
Start up time	Nominal Vin and constant resistive load	Single, Dual Power up 25mS typ.
	Single Remote ON/OFF	25mS typ.
UVLO Start-up voltage	Single	34VDC
	Dual	35VDC
UVLO Shutdown voltage	Single	32VDC
	Dual	33VDC
OVLO start-up voltage	Dual	76.5V typ.
OVLO shutdown voltage	Dual	78.5V typ.
Input reflected ripple current	Single	20mA p-p
Remote ON/OFF (Note 7)		
Single—		
(Negative logic)	ON=Short or 0V < Vr < 1.2V, I _{IN} =1mA max.	
	OFF=Open or 3V < Vr < 15V, I _{IN} =50µA max.	
(Positive logic)	ON=Open or 3V < Vr < 15V, I _{IN} =50µA max.	
	OFF=Short or 0V < Vr < 1.2V, I _{IN} =1mA max.	
Dual—		
(Positive logic)	ON=Open or 3V < Vr < +Vin	
	OFF=Short or Vr < 1.2V	
(Negative logic)	ON= Short or Vr < 1.2V	
	OFF=Open or 3V < Vr < +Vin	
Input current of remote control pin	Nominal Vin	-0.5mA ~ 0.5mA
Remote off state input current	Nominal Vin	20mA
ENVIRONMENTAL SPECIFICATIONS		
Operating base-plate temperature range (Note 8)		-40°C to +100°C (with derating)
Over temperature protection	Single	110°C
	Dual for base plate	105°C
Humidity max, Non-condensing		95%
Storage temperature range		-55°C to +125°C
Thermal shock		MIL-STD-810F
Vibration		MIL-STD-810F
EMC CHARACTERISTICS		
EMI (Note 9)	EN55022	Class A
Radiated immunity	EN61000-4-3	10 V/m Perf. Criteria A
Fast transient (Note 10)	EN61000-4-4	± 2KV Perf. Criteria B
Surge (Note 10)	EN61000-4-5	± 1KV Perf. Criteria B
Conducted immunity	EN61000-4-6	10 Vr.m.s Perf. Criteria A



Model Number	Input Range	Output Voltage	Output Current		Line Regulation	Load Regulation	Input Current		Eff ⁽⁴⁾ (%)
			Min. load	Full load			No load ⁽³⁾	Full load ⁽²⁾	
HEC100-48S1P8	36 – 75 VDC	1.8 VDC	0mA	25 A	4 mV	6 mV	110mA	1.172 A	85
HEC100-48S2P5	36 – 75 VDC	2.5 VDC	0mA	25 A	5 mV	8 mV	80mA	1.588 A	87
HEC100-48S3P3	36 – 75 VDC	3.3 VDC	0mA	25 A	7 mV	10 mV	100mA	2.046 A	89
HEC100-48S05	36 – 75 VDC	5.0 VDC	0mA	20 A	10 mV	15 mV	100mA	2.480 A	90
HEC100-48S15	36 – 75 VDC	15 VDC	0mA	6.66 A	30 mV	45 mV	200mA	2.507 A	90

Model Number	Input Range	Output Voltage		Output Current		Line Regulation		Load Regulation		Input Current		Eff ⁽⁴⁾ (%)
		V1	V2	I 1	I 2	V1	V2	V1	V2	No load ⁽³⁾	Full load ⁽²⁾	
HEC100-48D3305	36 – 75 VDC	5 VDC	3.3 VDC	20 A	25 A	25mV	16.5mV	25mV	16.5mV	200mA	2.48A	88
HEC100-48D2505	36 – 75 VDC	5 VDC	2.5 VDC	20 A	25 A	25mV	12.5mV	25mV	12.5mV	200mA	2.6A	85
HEC100-48D2533	36 – 75 VDC	3.3 VDC	2.5 VDC	25 A	25 A	16.5mV	12.5mV	16.5mV	12.5mV	190mA	2.59A	85

- Note
- BELLCORE TR-NWT-000332. Case 1: 50% Stress, Temperature at 40°C.
MIL-HDBK-217F Notice2 @Ta=25 °C, Full load(Ground, Benign, controlled environment).
 - Maximum value at nominal input voltage and full load.
 - Typical value at nominal input voltage and no load.
 - Typical value at nominal input voltage and full load.
The dual efficiency test condition: HEC100-48D3305 @ 5V/12A and 3.3V/12A
HEC100-48D2505 @ 5V/12A and 2.5V/16A
HEC100-48D2533 @ 3.3V/18A and 2.5V/16A
 - Maximum output deviation is 10% inclusive of remote sense. If remote sense is not being used, the +sense should be connected to its corresponding +OUTPUT and likewise the -sense should be connected to its corresponding -OUTPUT.
 - Single : Measured with a 1μF M/C and a 10μF T/C.
Dual : Measured without any external filter.
 - The negative / positive logic and pin length (DIM) are optional. The pin voltage is referenced to -Vin.
Single : Please see single output product options table.
Dual : Please see dual output product options table.
 - Heat sink is optional and P/N: 7G-0021A-F, 7G-0022A-F, 7G-0023A-F, 7G-0024A-F.
 - The HEC100 meets EN55022 class A and class B only with external components connected to the input pins to the converter.
 - An external input filter capacitor is required if the module has to meet EN61000-4-4, EN61000-4-5.
The filter capacitor Power Mate suggest: Nippon chemi-con KY series, 220μF /100V, ESR 48mΩ.
 - BASEPLATE GROUNDING : Base-plate should be grounded at one of four screw bolts prior to operation.
 - The converter is provided by basic insulation.



Single Output :

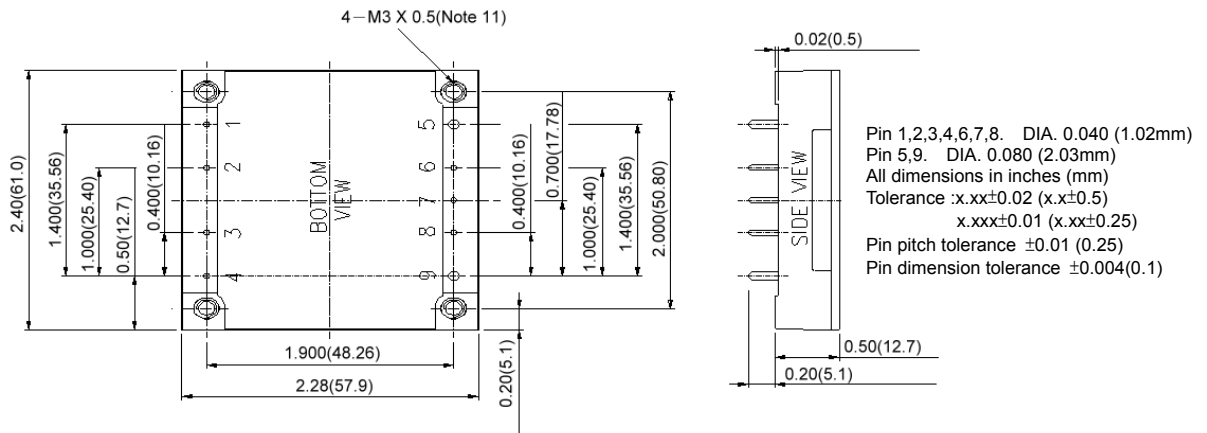

EXTERNAL OUTPUT

Output can be externally trimmed by using the method shown below.

TRIM UP TRIM DOWN

PIN CONNECTION		
PIN	Define	Diameter
1	- INPUT	0.04 Inches
2	CASE	0.04 Inches
3	CTRL	0.04 Inches
4	+ INPUT	0.04 Inches
5	- OUTPUT	0.08 Inches
6	- SENSE	0.04 Inches
7	TRIM	0.04 Inches
8	+ SENSE	0.04 Inches
9	+ OUTPUT	0.08 Inches

PRODUCT OPTIONS TABLE	
Option	Suffix
Negative remote ON/OFF logic, 0.20" pin length (standard)	-
Negative remote ON/OFF logic, 0.145" pin length	-L
Negative remote ON/OFF logic, 0.11" pin length	-K
Positive remote ON/OFF logic, 0.20" pin length	-P
Positive remote ON/OFF logic, 0.145" pin length	-S
Positive remote ON/OFF logic, 0.11" pin length	-M

Example : HEC100-48S3P3-P

Dual Output :

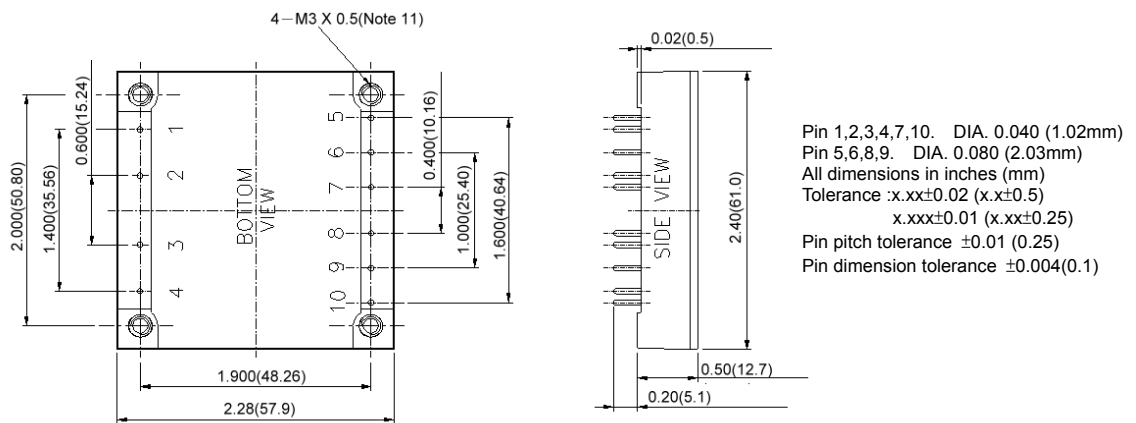

EXTERNAL OUTPUT TRIMMING

Output can be externally trimmed by using the method shown below.
() for V2 output trim

TRIM UP TRIM DOWN

PIN CONNECTION		
PIN	Define	Diameter
1	- INPUT	0.04 Inches
2	CASE	0.04 Inches
3	CTRL	0.04 Inches
4	+ INPUT	0.04 Inches
5	+ V 2	0.08 Inches
6	- V 2 (COM)	0.08 Inches
7	V2 TRIM	0.04 Inches
8	+ V 1	0.08 Inches
9	- V 1 (COM)	0.08 Inches
10	V1 TRIM	0.04 Inches

PRODUCT OPTIONS TABLE	
Option	Suffix
Positive remote ON/OFF logic, PIN 5,6,8,9 DIM 0.08"	-
Positive remote ON/OFF logic, PIN 5,6,8,9 DIM 0.04"	-Y
Negative remote ON/OFF logic, PIN 5,6,8,9 DIM 0.08"	-N
Negative remote ON/OFF logic, PIN 5,6,8,9 DIM 0.08"	-Z

Example : HEC100-48D3305-N

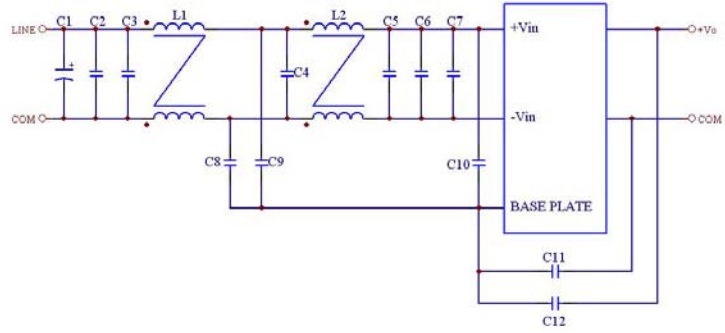
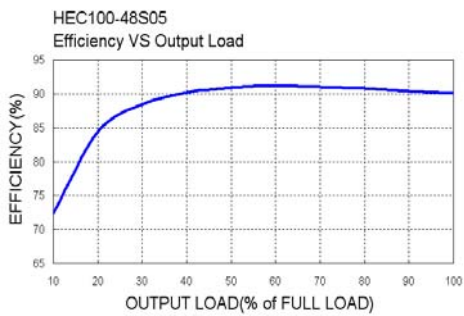
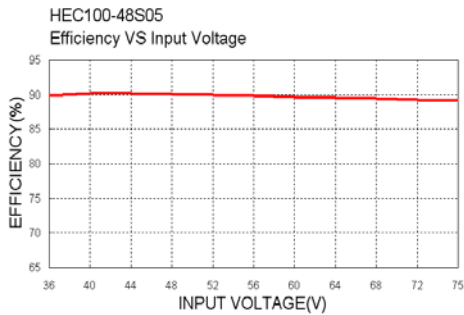
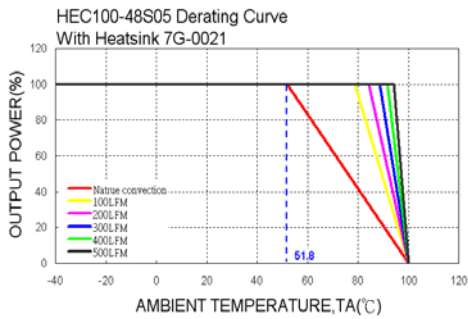
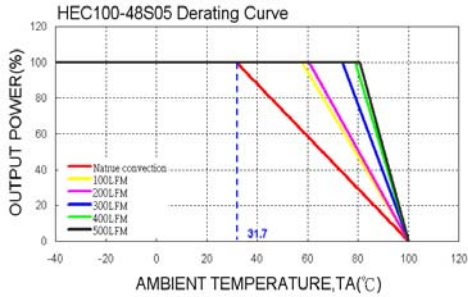

Recommended Filter for EN55022 Class B Compliance

The components used in the above figure, together with the manufacturers' part numbers for these components, are as follows:

	C1	C2	C3	C4	C5
HEC100-xxx	220μF/100V	2.2μF /100V	2.2μF /100V	2.2μF /100V	100μF/100V
	C6	C7	C8	C9	C10
	2.2μF /100V	2.2μF /100V	1.5nF /3KV	1.5nF /3KV	1.5nF /3KV
	C11	C12	L1	L2	
	1.5nF /3KV	1.5nF /3KV	1400.4μH	304.98μH	

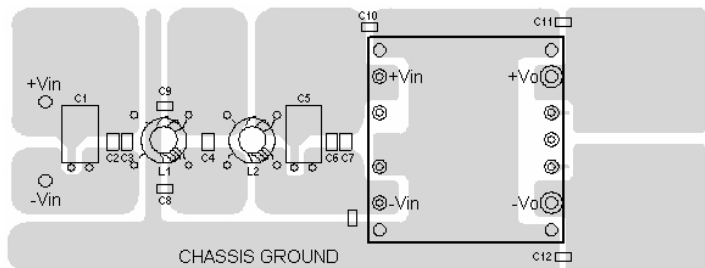

Recommended EN55022 Class B Filter Circuit Layout