



FEATURES

- 30 WATTS MAXIMUM OUTPUT POWER
- OUTPUT CURRENT UP TO 8A
- STANDARD 2.0 X 1.6 X 0.4 INCH PACKAGE
- HIGH EFFICIENCY UP TO 88%
- 4:1 WIDE INPUT VOLTAGE RANGE
- SIX-SIDED CONTINUOUS SHIELD
- FIXED SWITCHING FREQUENCY
- OFFER SINGLE AND DUAL OUTPUT
- CE MARK MEETS 2006/95/EC, 93/68/EEC AND 2004/108/EC
- UL60950-1, EN60950-1 AND IEC60950-1 LICENSED
- ISO9001 CERTIFIED MANUFACTURING FACILITIES
- COMPLIANT TO RoHS EU DIRECTIVE 2002/95/EC

APPLICATIONS

Wireless Network
Telecom/Datacom
Industry Control System
Measurement Equipment
Semiconductor Equipment

OPTIONS

Negative logic Remote On/Off

DESCRIPTION

The FEC30W series offer 30 watts of output power from a 2.0 x 1.6 x 0.4 inch package. The FEC30W series with 4:1 wide input voltage of 10-40VDC and 18-75VDC and features 1600VDC of isolation, short-circuit and over-voltage protection.

TECHNICAL SPECIFICATION

All specifications are typical at nominal input, full load and 25°C otherwise noted

OUTPUT SPECIFICATIONS		
Output power		30 Watts max.
Voltage accuracy	Full load and nominal Vin	± 1%
Minimum load		See Table
Voltage adjustability		± 10%
Line regulation	LL to HL at Full Load	± 0.5%
Load regulation	No Load to Full Load	± 0.5%
	Single Dual	± 1%
Cross regulation (Dual)	Asymmetrical load 25% / 100% FL	± 5%
Ripple and noise	20MHz bandwidth (Measured with a 0.1µF/50V MLCC)	See table
Temperature coefficient		± 0.02% / °C, max.
Transient response recovery time	25% load step change	250µS
Over voltage protection Zener diode clamp	1.5V output	3.9V
	1.8V output	3.9V
	2.5V output	3.9V
	3.3V output	3.9V
	5V output	6.2V
	12V output 15V output	15V 18V
Over load protection	% of FL at nominal input	150% max.
Short circuit protection		Hiccup, automatics recovery
GENERAL SPECIFICATIONS		
Efficiency		See table
Isolation voltage	Input to Output	1600VDC, min.
	Input (Output) to Case	1600VDC, min.
Isolation resistance		10 ⁹ ohms, min.
Isolation capacitance		1000pF, max.
Switching frequency		300KHz, typ.
Approvals and standard		IEC60950-1, UL60950-1, EN60950-1
Case material		Nickel-coated copper
Base material		FR4 PCB
Potting material		Epoxy (UL94-V0)
Dimensions		2.00 X 1.60 X 0.40 Inch (50.8 X 40.6 X 10.2 mm)
Weight		48g (1.69oz)
MTBF (Note 1)	BELLCORE TR-NWT-000332	1.315 x 10 ⁵ hrs
	MIL-HDBK-217F	3.456 x 10 ⁵ hrs

INPUT SPECIFICATIONS			
Input voltage range	24V nominal input	10 – 40VDC	
	48V nominal input	18 – 75VDC	
Input filter		L-C type	
Input surge voltage 100mS max.	24V input	50VDC	
	48V input	100VDC	
Input reflected ripple current	Nominal Vin and full load	20mA _{p-p}	
Start up time	Nominal Vin and constant resistive load	10mS typ.	
	Power up Remote ON/OFF	10mS typ.	
Start-up voltage	24V input	10VDC	
	48V input	18VDC	
Shutdown voltage	24V input	8VDC	
	48V input	16VDC	
Remote ON/OFF (Note 6) (Positive logic)(Standard)	DC-DC ON	Open or 3V < Vr < 12V	
	DC-DC OFF	Short or 0V < Vr < 1.2V	
	(Negative logic)(Option)	DC-DC ON	Short or 0V < Vr < 1.2V
		DC-DC OFF	Open or 3V < Vr < 12V
Input current of remote control pin	Nominal Vin	-0.5mA ~ +0.5mA	
Remote off state input current	Nominal Vin	3mA	
ENVIRONMENTAL SPECIFICATIONS			
Operating ambient temperature		-40°C ~ +85°C (with derating)	
Maximum case temperature		100°C	
Over temperature protection		115°C, typ.	
Storage temperature range		-55°C ~ +105°C	
Thermal impedance (Note 7)	Nature convection	10°C/Watt	
	Nature convection with heat-sink	8.24°C/Watt	
Thermal shock		MIL-STD-810F	
Vibration		MIL-STD-810F	
Relative humidity		5% to 95% RH	
EMC CHARACTERISTICS			
EMI (Note 8)	EN55022	Class A	
ESD	EN61000-4-2	Air ± 8KV	
		Contact ± 6KV	
Radiated immunity	EN61000-4-3	10 V/m Perf. Criteria A	
Fast transient (Note 9)	EN61000-4-4	± 2KV Perf. Criteria A	
Surge (Note 9)	EN61000-4-5	± 1KV Perf. Criteria B	
Conducted immunity	EN61000-4-6	10 Vr.m.s Perf. Criteria A	



Model Number	Input Range	Output Voltage	Output Current		Output (4) Ripple & Noise	Input Current		Eff (4) (%)	Capacitor (5) Load max
			Min. load	Full load		No load (3)	Full load (2)		
FEC30-24S1P5W	10 – 40 VDC	1.5 VDC	0mA	8000mA	60mVp-p	35mA	658mA	80	65000µF
FEC30-24S1P8W	10 – 40 VDC	1.8 VDC	0mA	8000mA	60mVp-p	35mA	759mA	83	65000µF
FEC30-24S2P5W	10 – 40 VDC	2.5 VDC	0mA	8000mA	60mVp-p	40mA	1029mA	85	33000µF
FEC30-24S3P3W	10 – 40 VDC	3.3 VDC	0mA	6000mA	60mVp-p	50mA	994mA	87	19500µF
FEC30-24S05W	10 – 40 VDC	5 VDC	0mA	6000mA	75mVp-p	65mA	1506mA	87	10200µF
FEC30-24S12W	10 – 40 VDC	12 VDC	0mA	2500mA	100mVp-p	65mA	1506mA	87	3300µF
FEC30-24S15W	10 – 40 VDC	15 VDC	0mA	2000mA	100mVp-p	70mA	1488mA	88	1100µF
FEC30-24D12W	10 – 40 VDC	±12VDC	0mA	±1250mA	100mVp-p	30mA	1563mA	84	±1000µF
FEC30-24D15W	10 – 40 VDC	±15VDC	0mA	±1000mA	100mVp-p	35mA	1543mA	85	±680µF
FEC30-48S1P5W	18 – 75 VDC	1.5 VDC	0mA	8000mA	60mVp-p	20mA	329mA	80	65000µF
FEC30-48S1P8W	18 – 75 VDC	1.8 VDC	0mA	8000mA	60mVp-p	20mA	380mA	83	65000µF
FEC30-48S2P5W	18 – 75 VDC	2.5 VDC	0mA	8000mA	60mVp-p	25mA	508mA	86	33000µF
FEC30-48S3P3W	18 – 75 VDC	3.3 VDC	0mA	6000mA	60mVp-p	30mA	497mA	87	19500µF
FEC30-48S05W	18 – 75 VDC	5 VDC	0mA	6000mA	75mVp-p	30mA	744mA	88	10200µF
FEC30-48S12W	18 – 75 VDC	12 VDC	0mA	2500mA	100mVp-p	35mA	753mA	87	3300µF
FEC30-48S15W	18 – 75 VDC	15 VDC	0mA	2000mA	100mVp-p	45mA	744mA	88	1100µF
FEC30-48D12W	18 – 75 VDC	±12VDC	0mA	±1250mA	100mVp-p	25mA	772mA	85	±1000µF
FEC30-48D15W	18 – 75 VDC	±15VDC	0mA	±1000mA	100mVp-p	25mA	762mA	86	±680µF

Note

- BELLCORE TR-NWT-000332. Case 1: 50% Stress, Temperature at 40°C. MIL-HDBK-217F Notice2 @ Ta=25 °C, Full load(Ground, Benign, controlled environment).
- Maximum value at nominal input voltage and full load.
- Typical value at nominal input voltage and no load.
- Typical value at nominal input voltage and full load.
- Test by minimum Vin and constant resistive load.
- The ON/OFF control pin voltage is referenced to -Vin. To order negative logic ON-OFF control add the suffix-N (Ex: FEC30-24S05W-N).
- Heat sink is optional and P/N: 7G-0011C-F.
- The FEC30W series can meet EN55022 Class A with parallel an external capacitor to the input pins. Recommend: 24Vin : 6.8µF/50V 1812 MLCC . 48Vin : 2.2µF/100V*2 PCS 1812 MLCC.
- An external input filter capacitor is required if the module has to meet EN61000-4-4, EN61000-4-5. The filter capacitor Power Mate suggest: Nippon chemi-con KY series, 220 µF/100V, ESR 48mΩ .

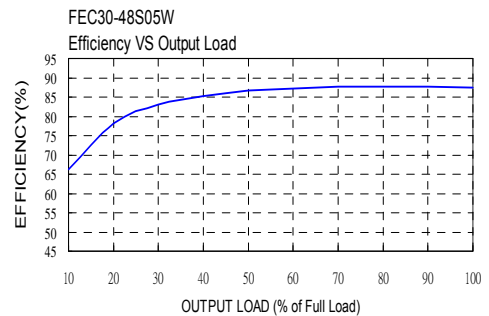
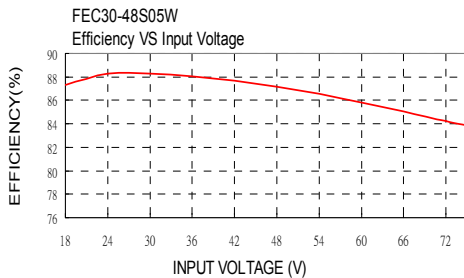
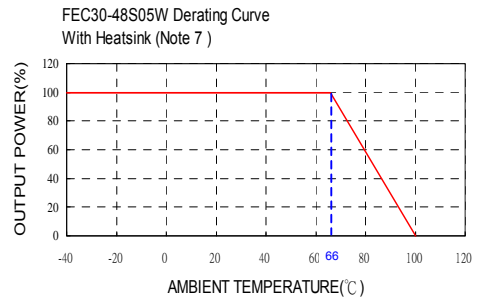
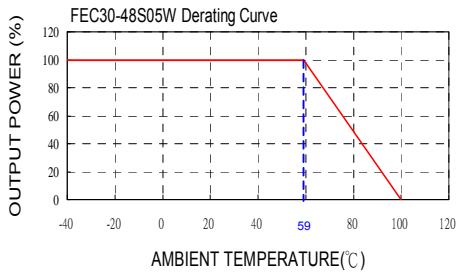

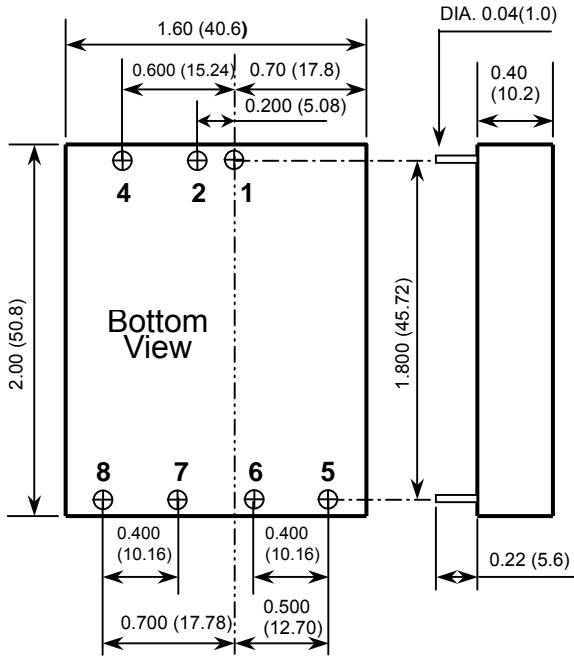

- All dimensions in Inches (mm)
Tolerance: X.XX±0.02 (X.X±0.5)
X.XXX±0.01 (X.XX±0.25)
- Pin pitch tolerance ±0.01(0.25)
- Pin dimension tolerance ±0.004 (0.1)

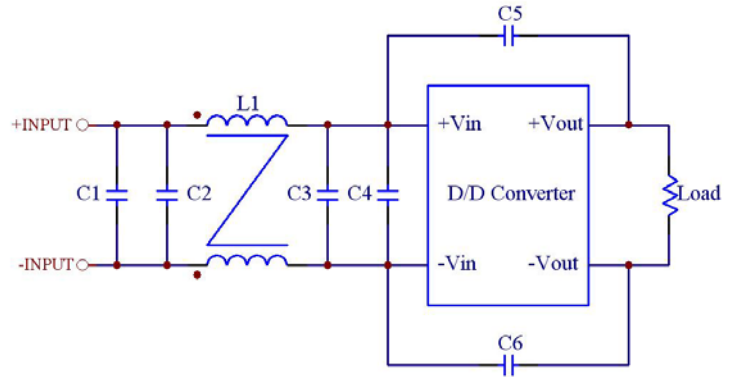

Recommended Filter for EN55022 Class B Compliance

The components used in the above figure, together with the manufacturers' part numbers for these components, are as follows:

	C1	C2	C3	C4	C5 & C6	L1
FEC30-24xxxW	6.8µF/50V 1812 MLCC	N/A	6.8µF/50V 1812 MLCC	N/A	1000pF/2KV MLCC	450µH Common Choke PMT-048
FEC30-48xxxW	2.2µF/100V 1812 MLCC	2.2µF/100V 1812 MLCC	2.2µF/100V 1812 MLCC	2.2µF/100V 1812 MLCC	1000pF/2KV MLCC	450µH Common Choke PMT-048

PIN CONNECTION		
PIN	SINGLE	DUAL
1	+ INPUT	+ INPUT
2	- INPUT	- INPUT
4	CTRL	CTRL
5	NO PIN	+ OUTPUT
6	+ OUTPUT	COMMON
7	- OUTPUT	- OUTPUT
8	TRIM	TRIM

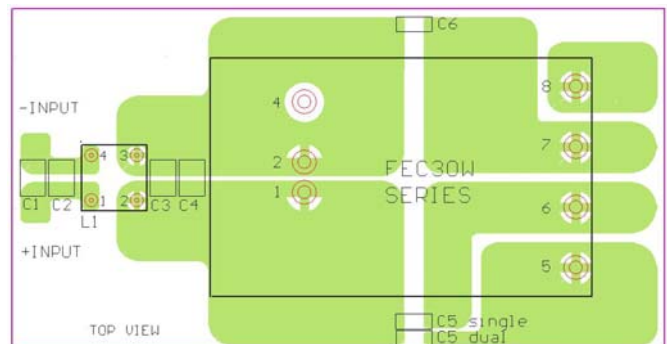
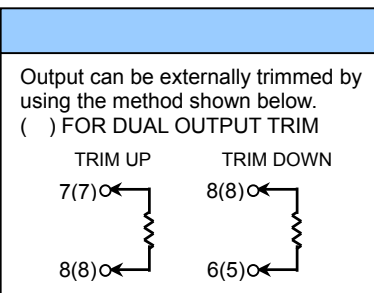

Recommended EN55022 Class B Filter Circuit Layout