

8-Mbit (1M x 8) Static RAM

Features

- Very high speed: 45 ns
 - Wide voltage range: 4.5V – 5.5V
- Ultra low active power
 - Typical active current: 1.8 mA @ f = 1 MHz
 - Typical active current: 18 mA @ f = f_{max}
- Ultra low standby power
 - Typical standby current: 2 μA
 - Maximum standby current: 8 μA
- Easy memory expansion with \overline{CE}_1 , CE₂ and \overline{OE} features
- Automatic power down when deselected
- CMOS for optimum speed and power
- Offered in Pb-free 44-Pin TSOP II package

Functional Description

The CY62158E MoBL[®] is a high performance CMOS static RAM organized as 1024K words by 8 bits. This device features advanced circuit design to provide ultra low active current. This

is ideal for providing More Battery Life™ (MoBL[®]) in portable applications such as cellular telephones. The device also has an automatic power down feature that significantly reduces power consumption. Placing the device into standby mode reduces power consumption significantly when deselected (\overline{CE}_1 HIGH or CE₂ LOW).

To write to the device, take Chip Enables (\overline{CE}_1 LOW and CE₂ HIGH) and Write Enable (\overline{WE}) input LOW. Data on the eight IO pins (IO₀ through IO₇) is then written into the location specified on the address pins (A₀ through A₁₉).

To read from the device, take Chip Enables (\overline{CE}_1 LOW and CE₂ HIGH) and \overline{OE} LOW while forcing the \overline{WE} HIGH. Under these conditions, the contents of the memory location specified by the address pins appear on the IO pins.

The eight input and output pins (IO₀ through IO₇) are placed in a high impedance state when the device is deselected (\overline{CE}_1 HIGH or CE₂ LOW), the outputs are disabled (\overline{OE} HIGH), or a write operation is in progress (CE₁ LOW and CE₂ HIGH and \overline{WE} LOW). See the Truth Table on page 8 for a complete description of read and write modes.

For best practice recommendations, refer to the Cypress application note [AN1064, SRAM System Guidelines](#).

Logic Block Diagram

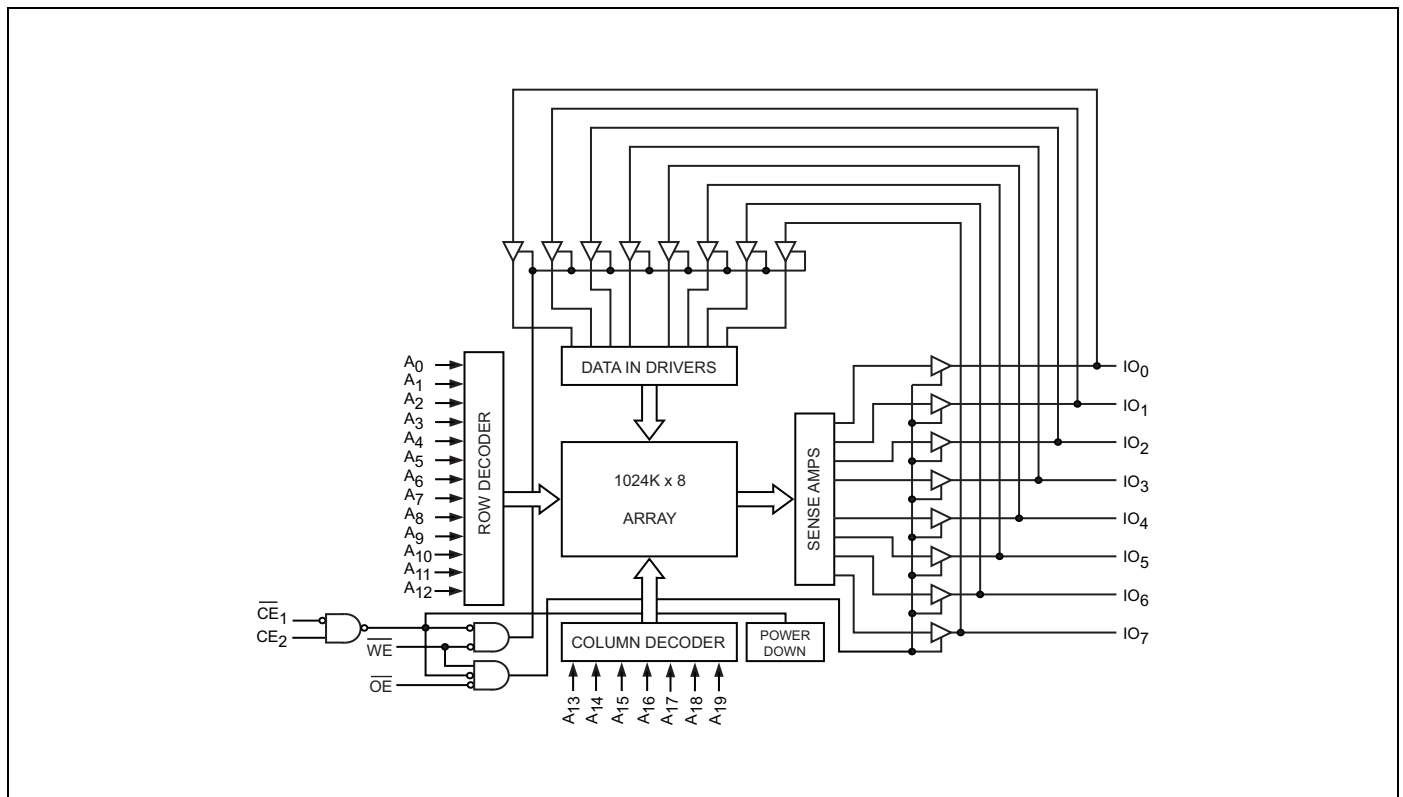

Pin Configuration

Figure 1. 44-Pin TSOP II (Top View) [1]

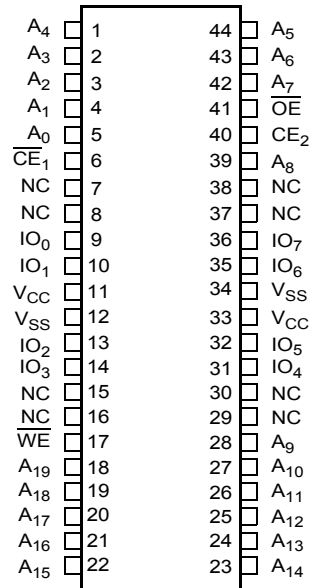

Product Portfolio

Product	V _{CC} Range (V)			Speed (ns)	Power Dissipation					
					Operating I _{CC} (mA)				Standby I _{SB2} (µA)	
					f = 1 MHz		f = f _{max}			
Min	Typ [2]	Max	Typ [2]	Max	Typ [2]	Max	Typ [2]	Max		
CY62158ELL-45	4.5	5.0	5.5	45	1.8	3	18	25	2	8

Notes

1. NC pins are not connected on the die.
2. Typical values are included for reference only and are not guaranteed or tested. Typical values are measured at V_{CC} = V_{CC(typ)}, T_A = 25°C.

Maximum Ratings

Exceeding the maximum ratings may impair the useful life of the device. These user guidelines are not tested.

Storage Temperature -65°C to +150°C

Ambient Temperature with Power Applied -55°C to +125°C

Supply Voltage to Ground Potential -0.5V to $V_{CC(max)}$ + 0.5V

DC Voltage Applied to Outputs in High-Z State^[3, 4] -0.5V to $V_{CC(max)}$ + 0.5V

DC Input Voltage^[3, 4] -0.5V to $V_{CC(max)}$ + 0.5V

Output Current into Outputs (LOW)..... 20 mA

Static Discharge Voltage..... >2001V (MIL-STD-883, Method 3015)

Latch up Current..... >200 mA

Operating Range

Device	Range	Ambient Temperature	V_{CC} ^[5]
CY62158ELL	Industrial	-40°C to +85°C	4.5V – 5.5V

Electrical Characteristics

Over the Operating Range

Parameter	Description	Test Conditions	-45			Unit
			Min	Typ ^[2]	Max	
V_{OH}	Output HIGH Voltage	$I_{OH} = -1$ mA	2.4			V
V_{OL}	Output LOW Voltage	$I_{OL} = 2.1$ mA			0.4	V
V_{IH}	Input HIGH Voltage	$V_{CC} = 4.5V$ to 5.5V	2.2		$V_{CC} + 0.5V$	V
V_{IL}	Input LOW Voltage	$V_{CC} = 4.5V$ to 5.5V	-0.5		0.8	V
I_{IX}	Input Leakage Current	$GND \leq V_I \leq V_{CC}$	-1		+1	μ A
I_{OZ}	Output Leakage Current	$GND \leq V_O \leq V_{CC}$, Output Disabled	-1		+1	μ A
I_{CC}	V_{CC} Operating Supply Current	$f = f_{MAX} = 1/t_{RC}$		18	25	mA
		$f = 1$ MHz		1.8	3	mA
I_{SB1}	Automatic CE Power down Current — CMOS Inputs	$CE_1 \geq V_{CC} - 0.2V$, $CE_2 \leq 0.2V$		2	8	μ A
		$V_{IN} \geq V_{CC} - 0.2V$, $V_{IN} \leq 0.2V$ $f = f_{MAX}$ (Address and Data Only), $f = 0$ (OE, and WE), $V_{CC} = V_{CCmax}$				
I_{SB2} ^[6]	Automatic CE Power-down Current — CMOS Inputs	$CE_1 \geq V_{CC} - 0.2V$ or $CE_2 \leq 0.2V$, $V_{IN} \geq V_{CC} - 0.2V$ or $V_{IN} \leq 0.2V$, $f = 0$, $V_{CC} = V_{CCmax}$		2	8	μ A

Capacitance

Tested initially and after any design or process changes that may affect these parameters.

Parameter	Description	Test Conditions	Max	Unit
C_{IN}	Input Capacitance	$T_A = 25^\circ C$, $f = 1$ MHz,	10	pF
C_{OUT}	Output Capacitance	$V_{CC} = V_{CC(typ)}$	10	pF

Thermal Resistance

Tested initially and after any design or process changes that may affect these parameters.

Parameter	Description	Test Conditions	TSOP II	Unit
Θ_{JA}	Thermal Resistance (Junction to Ambient)	Still Air, soldered on a 3 × 4.5 inch, two-layer printed circuit board	75.13	$^\circ C/W$
Θ_{JC}	Thermal Resistance (Junction to Case)		8.95	$^\circ C/W$

Notes

- $V_{IL}(min) = -2.0V$ for pulse durations less than 20 ns.
- $V_{IH}(max) = V_{CC} + 0.75V$ for pulse durations less than 20 ns.
- Full Device AC operation assumes a 100 μ s ramp time from 0 to $V_{CC}(min)$ and 200 μ s wait time after V_{CC} stabilization.
- Only chip enables (CE_1 and CE_2), must be tied to CMOS levels to meet the I_{SB2} / I_{CCDR} spec. Other inputs can be left floating.

AC Test Loads and Waveforms

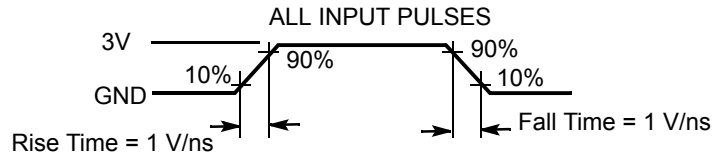
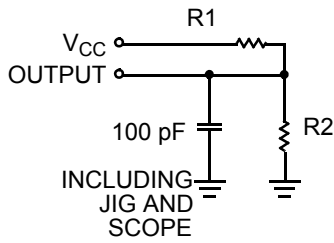

Equivalent to: THÉVENIN EQUIVALENT



Parameters	5.0V	Unit
R1	1838	Ω
R2	994	Ω
R _{TH}	645	Ω
V _{TH}	1.75	V

Data Retention Characteristics

Over the Operating Range

Parameter	Description	Conditions	Min	Typ ^[2]	Max	Unit
V _{DR}	V _{CC} for Data Retention		2			V
I _{CCDR} ^[6]	Data Retention Current	V _{CC} = V _{DR} CE ₁ ≥ V _{CC} - 0.2V, CE ₂ ≤ 0.2V, V _{IN} ≥ V _{CC} - 0.2V or V _{IN} ≤ 0.2V			8	μ A
t _{CDR} ^[7]	Chip Deselect to Data Retention Time		0			ns
t _R ^[8]	Operation Recovery Time		t _{RC}			ns

Data Retention Waveform

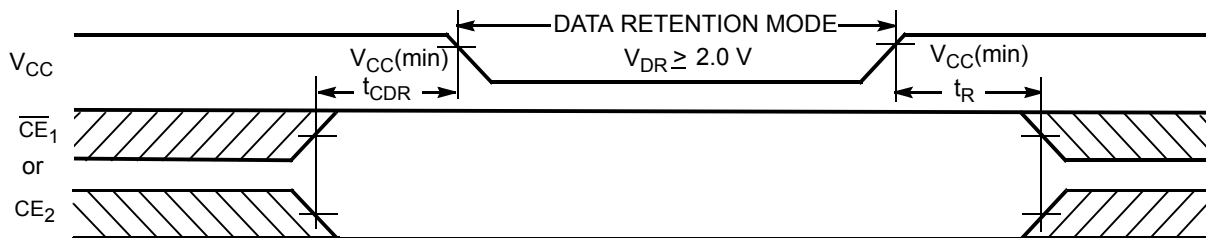

Notes

- 7. Tested initially and after any design or process changes that may affect these parameters.
- 8. Full device operation requires linear V_{CC} ramp from V_{DR} to V_{CC}(min) ≥ 100 μ s or stable at V_{CC}(min) ≥ 100 μ s.

Switching Characteristics

Over the Operating Range ^[9]

Parameter	Description	45 ns		Unit
		Min	Max	
Read Cycle				
t_{RC}	Read Cycle Time	45		ns
t_{AA}	Address to Data Valid		45	ns
t_{OHA}	Data Hold from Address Change	10		ns
t_{ACE}	\overline{CE}_1 LOW and CE_2 HIGH to Data Valid		45	ns
t_{DOE}	\overline{OE} LOW to Data Valid		22	ns
t_{LZOE}	\overline{OE} LOW to Low Z ^[10]	5		ns
t_{HZOE}	\overline{OE} HIGH to High Z ^[10, 11]		18	ns
t_{LZCE}	\overline{CE}_1 LOW and CE_2 HIGH to Low Z ^[10]	10		ns
t_{HZCE}	\overline{CE}_1 HIGH or CE_2 LOW to High Z ^[10, 11]		18	ns
t_{PU}	\overline{CE}_1 LOW and CE_2 HIGH to Power Up	0		ns
t_{PD}	\overline{CE}_1 HIGH or CE_2 LOW to Power Down		45	ns
Write Cycle ^[12]				
t_{WC}	Write Cycle Time	45		ns
t_{SCE}	\overline{CE}_1 LOW and CE_2 HIGH to Write End	35		ns
t_{AW}	Address Setup to Write End	35		ns
t_{HA}	Address Hold from Write End	0		ns
t_{SA}	Address Setup to Write Start	0		ns
t_{PWE}	\overline{WE} Pulse Width	35		ns
t_{SD}	Data Setup to Write End	25		ns
t_{HD}	Data Hold from Write End	0		ns
t_{HZWE}	\overline{WE} LOW to High Z ^[10, 11]		18	ns
t_{LZWE}	\overline{WE} HIGH to Low Z ^[10]	10		ns

Notes

9. Test conditions for all parameters other than tri-state parameters assume signal transition time of 3 ns or less (1V/ns), timing reference levels of $V_{CC(typ)}/2$, input pulse levels of 0 to $V_{CC(typ)}$, and output loading of the specified I_{OL}/I_{OH} as shown in "AC Test Loads and Waveforms" on page 4.
10. At any given temperature and voltage condition, t_{HZCE} is less than t_{LZCE} , t_{HZOE} is less than t_{LZOE} , and t_{HZWE} is less than t_{LZWE} for any given device.
11. t_{HZOE} , t_{HZCE} , and t_{HZWE} transitions are measured when the outputs enter a high impedance state.
12. The internal write time of the memory is defined by the overlap of \overline{WE} , $\overline{CE}_1 = V_{L}$, and $CE_2 = V_{H}$. All signals must be ACTIVE to initiate a write and any of these signals can terminate a write by going INACTIVE. The data input setup and hold timing should be referenced to the edge of the signal that terminates the write.

Switching Waveforms

Figure 2 shows address transition controlled read cycle waveforms.^[13, 14]

Figure 2. Read Cycle No. 1

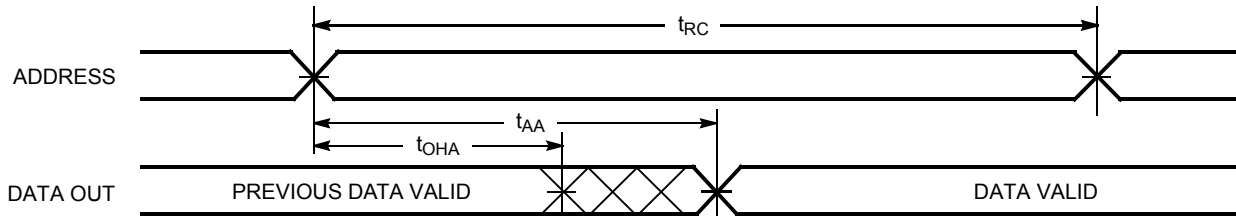
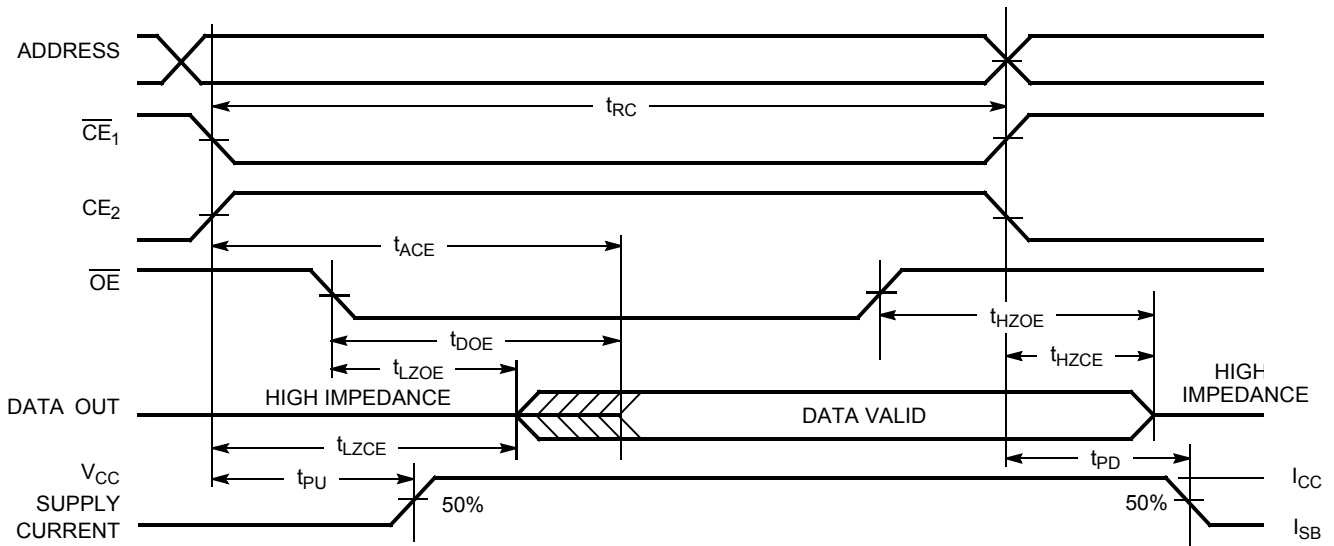

Figure 3 shows \overline{OE} controlled read cycle waveforms.^[14, 15]

Figure 3. Read Cycle No. 2



Notes

13. Device is continuously selected. \overline{OE} , $\overline{CE}_1 = V_{IL}$. $CE_2 = V_{IH}$.
14. WE is HIGH for read cycle.
15. Address valid before or similar to \overline{CE}_1 transition LOW and CE_2 transition HIGH.

Switching Waveforms (continued)

Figure 4 shows \overline{WE} controlled write cycle waveforms.^[12, 16, 17]

Figure 4. Write Cycle No. 1

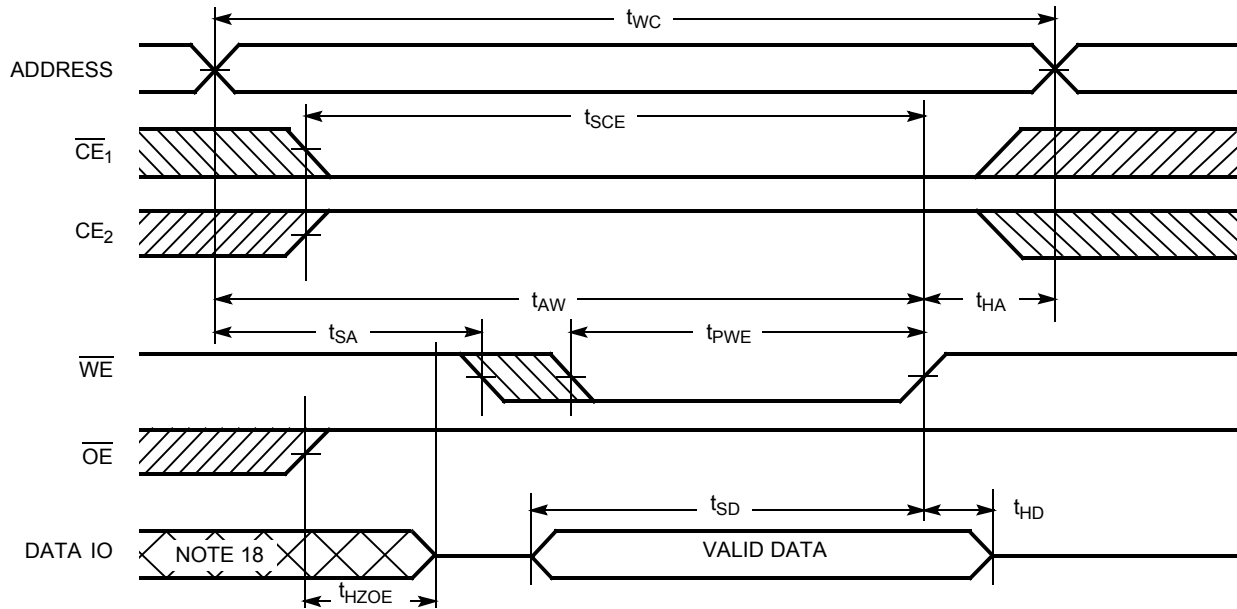
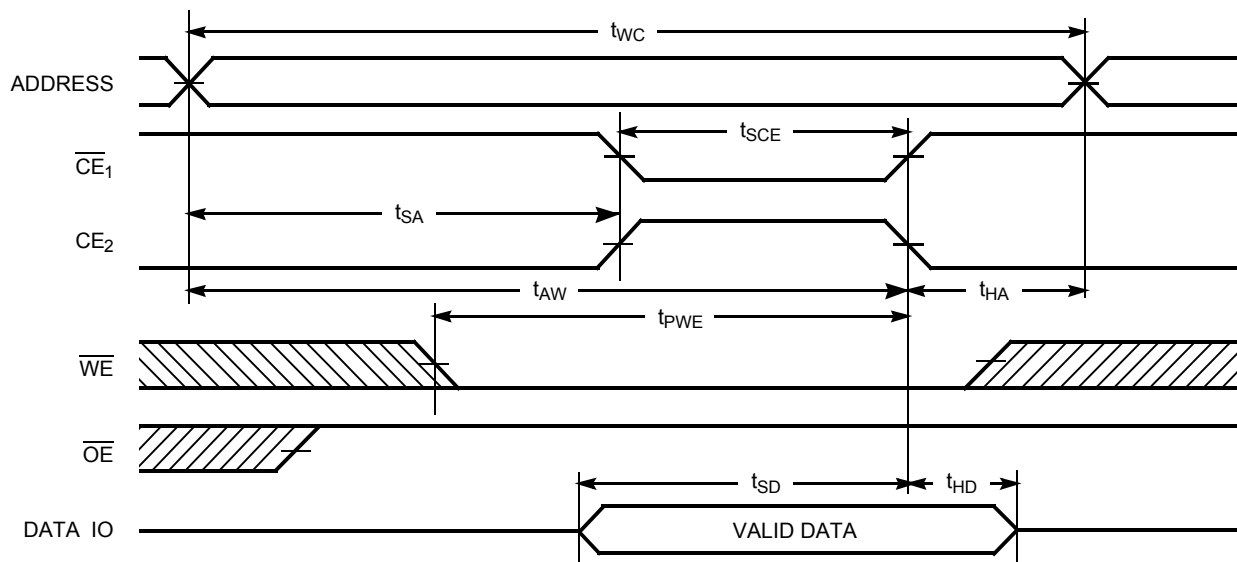

Figure 5 shows \overline{CE}_1 or CE_2 controlled write cycle waveforms.^[12, 16, 17]

Figure 5. Write Cycle No. 2



Notes

- 16. Data IO is high impedance if $\overline{OE} = V_{IH}$.
- 17. If \overline{CE}_1 goes HIGH or CE_2 goes LOW simultaneously with \overline{WE} HIGH, the output remains in high impedance state.
- 18. During this period, the IOs are in output state. Do not apply input signals.

Switching Waveforms (continued)

Figure 6 shows \overline{WE} controlled, \overline{OE} LOW write cycle waveforms.^[17]

Figure 6. Write Cycle No. 3

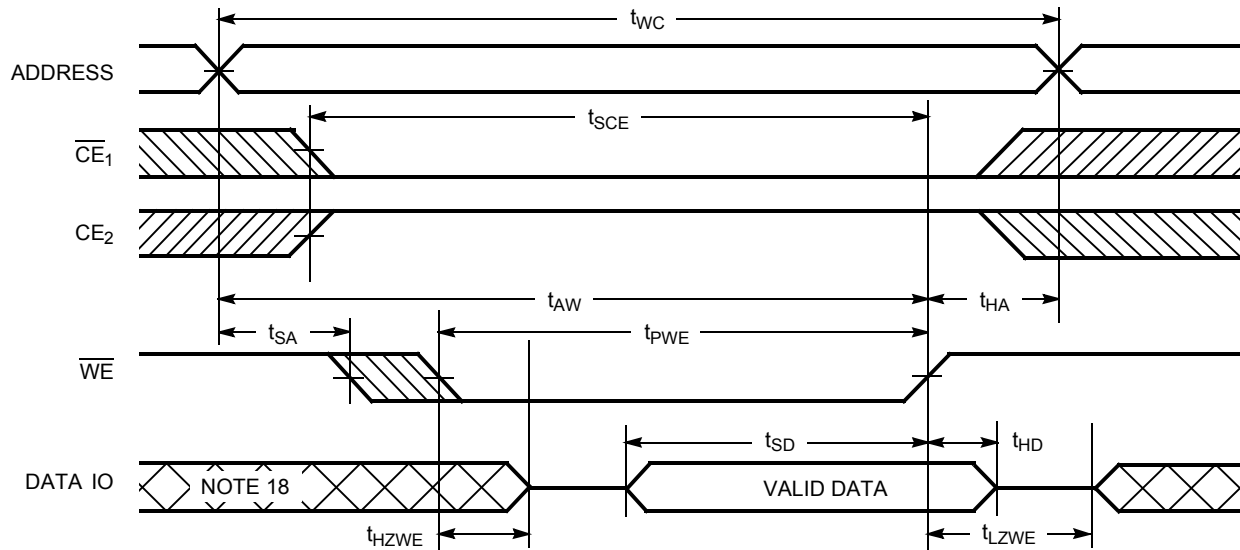

Truth Table

\overline{CE}_1	\overline{CE}_2	\overline{WE}	\overline{OE}	Inputs/Outputs	Mode	Power
H	X	X	X	High Z	Deselect/Power Down	Standby (I_{SB})
X	L	X	X	High Z	Deselect/Power Down	Standby (I_{SB})
L	H	H	L	Data Out	Read	Active (I_{CC})
L	H	H	H	High Z	Output Disabled	Active (I_{CC})
L	H	L	X	Data in	Write	Active (I_{CC})

Ordering Information

Speed (ns)	Ordering Code	Package Diagram	Package Type	Operating Range
45	CY62158ELL-45ZSXI	51-85087	48-Pin TSOP II (Pb-free)	Industrial

Package Diagrams

Figure 7. 44-Pin TSOP II, 51-85087

DIMENSION IN MM (INCH)
MAX
MIN

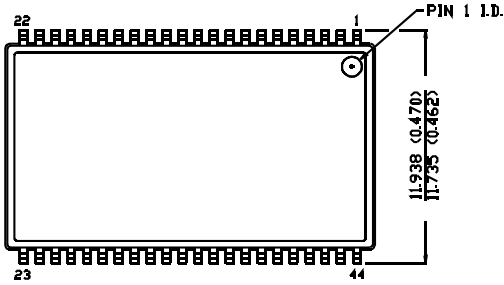

TOP VIEW

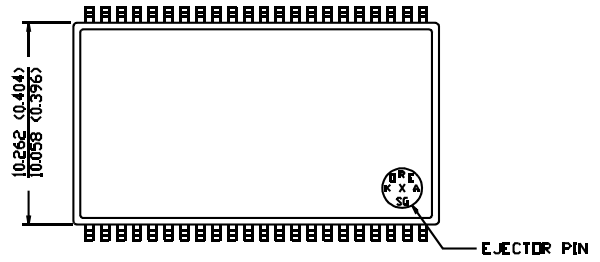

BOTTOM VIEW

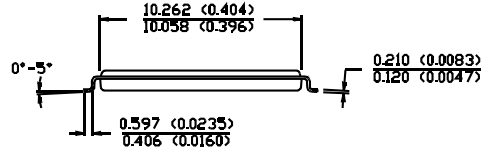
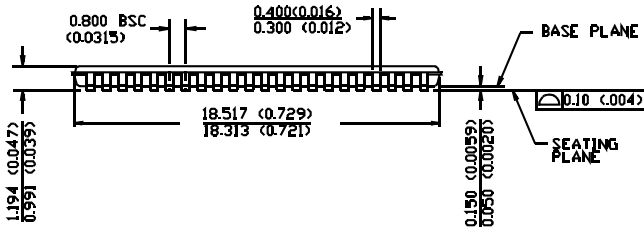

51-85087-A

Document History Page

Document Title: CY62158E MoBL® 8-Mbit (1M x 8) Static RAM Document Number: 38-05684				
REV.	ECN NO.	Issue Date	Orig. of Change	Description of Change
**	270350	See ECN	PCI	New Data Sheet
*A	291271	See ECN	SYT	Converted from Advance Information to Preliminary Changed input pulse level from V_{CC} to 3V in the AC Test Loads and Waveforms Modified footnote #9 to include timing reference level of 1.5V and input pulse level of 3V
*B	1462592	See ECN	VKN/AESA	Converted from preliminary to final Removed 35 ns speed bin Removed "L" parts Removed 48-Ball VFPGA package Changed $I_{CC(max)}$ spec from 2.3 mA to 3 mA at $f=1$ MHz Changed $I_{CC(typ)}$ spec from 16 mA to 18 mA at $f=f_{MAX}$ Changed $I_{CC(max)}$ spec from 28 mA to 25 mA at $f=f_{MAX}$ Changed $I_{SB1(typ)}$ and $I_{SB2(typ)}$ spec from 0.9 μA to 2 μA Changed $I_{SB1(max)}$ and $I_{SB2(max)}$ spec from 4.5 μA to 8 μA Changed $I_{CCDR(max)}$ spec from 4.5 μA to 8 μA Changed t_{LZOE} spec from 3 ns to 5 ns Changed t_{LZCE} spec from 6 ns to 10 ns Changed t_{HZCE} spec from 22 ns to 18 ns Changed t_{PWE} spec from 30 ns to 35 ns Changed t_{SD} spec from 22 ns to 25 ns Changed t_{LZWE} spec from 6 ns to 10 ns Added footnote# 6 related to I_{SB2} and I_{CCDR} Updated Ordering information table

© Cypress Semiconductor Corporation, 2004-2007. The information contained herein is subject to change without notice. Cypress Semiconductor Corporation assumes no responsibility for the use of any circuitry other than circuitry embodied in a Cypress product. Nor does it convey or imply any license under patent or other rights. Cypress products are not warranted nor intended to be used for medical, life support, life saving, critical control or safety applications, unless pursuant to an express written agreement with Cypress. Furthermore, Cypress does not authorize its products for use as critical components in life-support systems where a malfunction or failure may reasonably be expected to result in significant injury to the user. The inclusion of Cypress products in life-support systems application implies that the manufacturer assumes all risk of such use and in doing so indemnifies Cypress against all charges.

Any Source Code (software and/or firmware) is owned by Cypress Semiconductor Corporation (Cypress) and is protected by and subject to worldwide patent protection (United States and foreign), United States copyright laws and international treaty provisions. Cypress hereby grants to licensee a personal, non-exclusive, non-transferable license to copy, use, modify, create derivative works of, and compile the Cypress Source Code and derivative works for the sole purpose of creating custom software and or firmware in support of licensee product to be used only in conjunction with a Cypress integrated circuit as specified in the applicable agreement. Any reproduction, modification, translation, compilation, or representation of this Source Code except as specified above is prohibited without the express written permission of Cypress.

Disclaimer: CYPRESS MAKES NO WARRANTY OF ANY KIND, EXPRESS OR IMPLIED, WITH REGARD TO THIS MATERIAL, INCLUDING, BUT NOT LIMITED TO, THE IMPLIED WARRANTIES OF MERCHANTABILITY AND FITNESS FOR A PARTICULAR PURPOSE. Cypress reserves the right to make changes without further notice to the materials described herein. Cypress does not assume any liability arising out of the application or use of any product or circuit described herein. Cypress does not authorize its products for use as critical components in life-support systems where a malfunction or failure may reasonably be expected to result in significant injury to the user. The inclusion of Cypress' product in a life-support systems application implies that the manufacturer assumes all risk of such use and in doing so indemnifies Cypress against all charges.

Use may be limited by and subject to the applicable Cypress software license agreement.