

## FEATURES

- Low Supply Current...20  $\mu$ A Typ
- Single Power Supply
- Rail-to-Rail Common-Mode Input Voltage Range
- Push-Pull Output Circuit
- Low Input-Bias Current

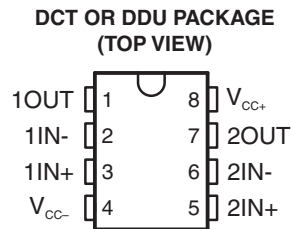

## APPLICATIONS

- Battery Packs for Sensing Battery Voltage
- MP3 Players, Digital Cameras, PMPs
- Cellular Phones, PDAs, Notebook Computers
- Test Equipment
- General-Purpose Low-Voltage Applications

## DESCRIPTION/ORDERING INFORMATION

The TLV7256 is a CMOS-type general-purpose dual comparator capable of single power-supply operation and using lower supply currents than the conventional bipolar comparators. Its push-pull output can connect directly to local ICs such as TTL and CMOS circuits.

### ORDERING INFORMATION<sup>(1)</sup>

$T_A$	PACKAGE <sup>(2)</sup>		ORDERABLE PART NUMBER	TOP-SIDE MARKING
-40°C to 85°C	SSOP – DCT	Reel of 3000	TLV7256IDCTR	PREVIEW
		Reel of 250	TLV7256IDCTT	
	VSSOP – DDU	Reel of 3000	TLV7256IDDUR	YAUA

- (1) For the most current package and ordering information, see the Package Option Addendum at the end of this document, or see the TI web site at [www.ti.com](http://www.ti.com).  
 (2) Package drawings, standard packing quantities, thermal data, symbolization, and PCB design guidelines are available at [www.ti.com/sc/package](http://www.ti.com/sc/package).

## Typical Application Circuit

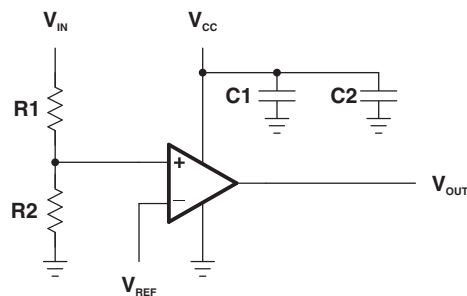

Figure 1. Threshold Detector



Please be aware that an important notice concerning availability, standard warranty, and use in critical applications of Texas Instruments semiconductor products and disclaimers thereto appears at the end of this data sheet.

# TLV7256 DUAL COMPARATOR

SLCS147A–OCTOBER 2006–REVISED JANUARY 2007

## Absolute Maximum Ratings<sup>(1)</sup>

over operating free-air temperature range (unless otherwise noted)

		MIN	MAX	UNIT
V <sub>CC</sub>	Supply voltage	1.5	7	V
V <sub>ID</sub>	Differential input voltage			V
V <sub>I</sub>	Input voltage	V <sub>CC-</sub>	V <sub>CC+</sub>	V
I <sub>O</sub>	Output current		±35	mA
θ <sub>JA</sub>	Thermal resistance, junction to ambient <sup>(2)</sup>	DCT package	220	°C/W
		DDU package	227	
P <sub>D</sub>	Power dissipation	DCT package	250	mW
		DDU package	200	
T <sub>A</sub>	Operating free-air temperature range	–40	85	°C
T <sub>stg</sub>	Storage temperature range	–55	125	°C

(1) Stresses beyond those listed under *absolute maximum ratings* may cause permanent damage to the device. These are stress ratings only, and functional operation of the device at these or any other conditions beyond those indicated under *recommended operating conditions* is not implied. Exposure to absolute-maximum-rated conditions for extended periods may affect device reliability.

(2) Package thermal impedance is calculated according to JESD 51-7.

## Recommended Operating Conditions

		MIN	MAX	UNIT
V <sub>CC</sub>	Supply voltage	1.8	5	V
T <sub>A</sub>	Operating free-air temperature	–40	85	°C

**Electrical Characteristics**
 $V_{CC+} = 5\text{ V}$ ,  $V_{CC-} = \text{GND}$ ,  $T_A = 25^\circ\text{C}$  (unless otherwise noted)

PARAMETER		TEST CONDITIONS	$T_A$	MIN	TYP	MAX	UNIT	
$V_{IO}$	Input offset voltage		25°C		±2	±7	mV	
			–40°C to 85°C			±8		
$I_{IO}$	Input offset current		25°C		2		pA	
$I_I$	Input bias current		25°C		4		pA	
$V_{CM}$	Common-mode input voltage		25°C	0		$V_{CC}$	V	
CMRR	Common-mode rejection ratio	$\Delta V_{CM} = 5\text{ V}$	25°C	48	65		dB	
		$0 \leq V_{CM} \leq 5\text{ V}$	–40°C to 85°C	48				
$I_{CC}$	Supply current	Output = High, $V_{IN} = 5\text{ V}$	25°C		37	51	$\mu\text{A}$	
		Output = Low, $V_{IN} = 5\text{ V}$			40	60		
		Output = High, $V_{IN} = 5\text{ V}$	–40°C to 85°C			61		
		Output = Low, $V_{IN} = 5\text{ V}$				70		
		Output = High, $V_{IN} = 2.5\text{ V}$	25°C		20	32		
		Output = Low, $V_{IN} = 2.5\text{ V}$			26	42		
		Output = High, $V_{IN} = 2.5\text{ V}$	–40°C to 85°C			40		
		Output = Low, $V_{IN} = 2.5\text{ V}$				53		
$A_{VD}$	Voltage gain	$V_D = 3\text{ V}$ , $1\text{ V} \leq V_{OUT} \leq 4\text{ V}$	25°C		88		dB	
$I_{sink}$	Sink current	$V_{OL} = 0.5\text{ V}$	25°C	25	33		mA	
			–40°C to 85°C		20			
$I_{source}$	Source current	$V_{OH} = 4.5\text{ V}$	25°C	30	35		mA	
			–40°C to 85°C		25			
$V_{OL}$	Low-level output voltage	$I_{sink} = 5\text{ mA}$	25°C		0.07	0.12	V	
			–40°C to 85°C			0.20		
$V_{OH}$	High-level output voltage	$I_{source} = 5\text{ mA}$	25°C	4.9	4.93		V	
			–40°C to 85°C		4.85			

# TLV7256 DUAL COMPARATOR

SLCS147A–OCTOBER 2006–REVISED JANUARY 2007

## Electrical Characteristics

$V_{CC+} = 2.7\text{ V}$ ,  $V_{CC-} = \text{GND}$ ,  $T_A = 25^\circ\text{C}$  (unless otherwise noted)

PARAMETER		TEST CONDITIONS	$T_A$	MIN	TYP	MAX	UNIT	
$V_{IO}$	Input offset voltage		25°C		±2	±8	mV	
			–40°C to 85°C			±9		
$I_{IO}$	Input offset current		25°C		2		pA	
$I_I$	Input bias current		25°C		4		pA	
$V_{CM}$	Common-mode input voltage		25°C	0		$V_{CC}$	V	
CMRR	Common-mode rejection ratio	$\Delta V_{CM} = 2.7\text{ V}$	25°C	42	57		dB	
		$0 \leq V_{CM} \leq 2.7\text{ V}$	–40°C to 85°C	42				
$I_{CC}$	Supply current	Output = High, $V_{IN} = 2.7\text{ V}$	25°C		30	55	$\mu\text{A}$	
		Output = Low, $V_{IN} = 2.7\text{ V}$			36	55		
		Output = High, $V_{IN} = 2.7\text{ V}$	–40°C to 85°C			65		
		Output = Low, $V_{IN} = 2.7\text{ V}$				65		
		Output = High, $V_{IN} = 1.35\text{ V}$	25°C		30	48		
		Output = Low, $V_{IN} = 1.35\text{ V}$			35	55		
		Output = High, $V_{IN} = 1.35\text{ V}$	–40°C to 85°C			55		
		Output = Low, $V_{IN} = 1.35\text{ V}$				65		
$A_{VD}$	Voltage gain	$V_D = 1.7\text{ V}$ , $0.5\text{ V} \leq V_{OUT} \leq 2.2\text{ V}$	25°C		88		dB	
$I_{sink}$	Sink current	$V_{OL} = 0.5\text{ V}$	25°C	13	18		mA	
			–40°C to 85°C		11			
$I_{source}$	Source current	$V_{OH} = 2.2\text{ V}$	25°C	15	20		mA	
			–40°C to 85°C		13			
$V_{OL}$	Low-level output voltage	$I_{sink} = 5\text{ mA}$	25°C		0.11	0.16	V	
			–40°C to 85°C			0.19		
$V_{OH}$	High-level output voltage	$I_{source} = 5\text{ mA}$	25°C	2.54	2.60		V	
			–40°C to 85°C		2.45			

## Electrical Characteristics

$V_{CC+} = 1.8\text{ V}$ ,  $V_{CC-} = \text{GND}$ ,  $T_A = 25^\circ\text{C}$  (unless otherwise noted)

PARAMETER		TEST CONDITIONS	$T_A$	MIN	TYP	MAX	UNIT	
$V_{IO}$	Input offset voltage		25°C		±2	±8	mV	
			-40°C to 85°C			±9		
$I_{IO}$	Input offset current		25°C		2		pA	
$I_I$	Input bias current		25°C		4		pA	
$V_{CM}$	Common-mode input voltage		25°C	0		$V_{CC} - 0.3$	V	
CMRR	Common-mode rejection ratio	$\Delta V_{CM} = 5\text{ V}$	25°C	40	55		dB	
		$0 \leq V_{CM} \leq 5\text{ V}$	-40°C to 85°C	40				
$I_{CC}$	Supply current	Output = High, $V_{IN} = 1.8\text{ V}$	25°C		30	55	$\mu\text{A}$	
		Output = Low, $V_{IN} = 1.8\text{ V}$			33	47		
		Output = High, $V_{IN} = 1.8\text{ V}$	-40°C to 85°C			60		
		Output = Low, $V_{IN} = 1.8\text{ V}$				51		
		Output = High, $V_{IN} = 0.9\text{ V}$	25°C		20	32		
		Output = Low, $V_{IN} = 0.9\text{ V}$			25	37		
		Output = High, $V_{IN} = 0.9\text{ V}$	-40°C to 85°C			34		
		Output = Low, $V_{IN} = 0.9\text{ V}$				40		
$A_{VD}$	Voltage gain	$V_D = 1.1\text{ V}$ , $0.4\text{ V} \leq V_{OUT} \leq 1.5\text{ V}$	25°C		88		dB	
$I_{sink}$	Sink current	$V_{OL} = 0.5\text{ V}$	25°C	6	9		mA	
			-40°C to 85°C	5				
$I_{source}$	Source current	$V_{OH} = 2.2\text{ V}$	25°C	5	9		mA	
			-40°C to 85°C	4				
$V_{OL}$	Low-level output voltage	$I_{sink} = 5\text{ mA}$	25°C		0.2	0.34	V	
			-40°C to 85°C			0.39		
$V_{OH}$	High-level output voltage	$I_{source} = 5\text{ mA}$	25°C	1.3	1.6		V	
			-40°C to 85°C	1.2				

**Switching Characteristics**

$V_{CC+} = 5\text{ V}$ ,  $V_{CC-} = \text{GND}$ ,  $T_A = 25^\circ\text{C}$  (unless otherwise noted)

PARAMETER		TEST CONDITIONS	TYP	UNIT
$t_{PLH}$	Propagation delay time (turn on)	Overdrive = 100 mV	680	ns
		TTL step input	500	
$t_{PHL}$	Propagation delay time (turn off)	Overdrive = 100 mV	250	ns
		TTL step input	380	
$t_{TLH}$	Response time	Overdrive = 100 mV	60	ns
$t_{THL}$			8	

**Switching Characteristics**

$V_{CC+} = 3\text{ V}$ ,  $V_{CC-} = \text{GND}$ ,  $T_A = 25^\circ\text{C}$  (unless otherwise noted)

PARAMETER		TEST CONDITIONS	TYP	UNIT
$t_{PLH}$	Propagation delay time (turn on)	Overdrive = 100 mV	550	ns
$t_{PHL}$	Propagation delay time (turn off)	Overdrive = 100 mV	250	ns
$t_{TLH}$	Response time	Overdrive = 100 mV	30	ns
$t_{THL}$			8	

**TYPICAL CHARACTERISTICS**

**SUPPLY CURRENT  
VS  
FREQUENCY  
 $V_{CC} = 5\text{ V}$**

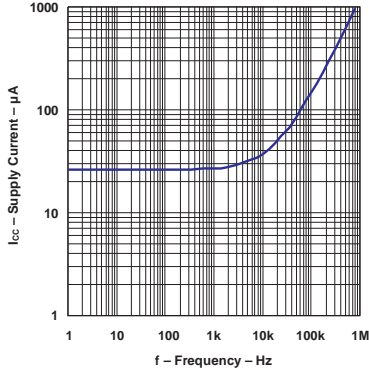

**SUPPLY CURRENT  
VS  
FREQUENCY  
 $V_{CC} = 2.7\text{ V}$**

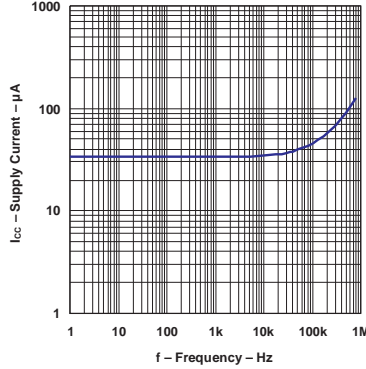

**SUPPLY CURRENT  
VS  
FREQUENCY  
 $V_{CC} = 1.8\text{ V}$**

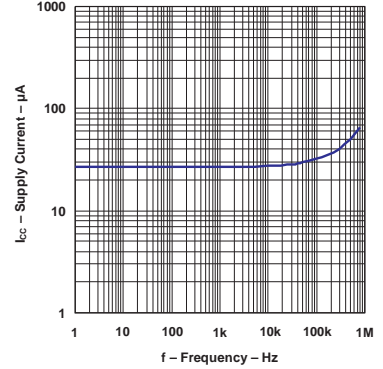

**SUPPLY CURRENT  
VS  
COMMON-MODE VOLTAGE  
 $V_{CC} = \pm 2.5\text{ V}$**

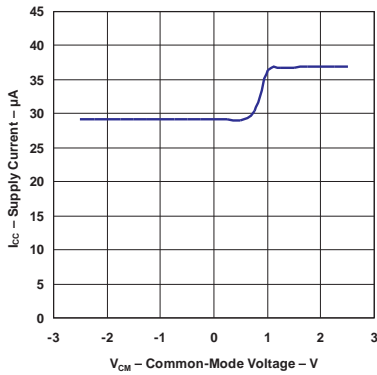

**SUPPLY CURRENT  
VS  
COMMON-MODE VOLTAGE  
 $V_{CC} = \pm 1.35\text{ V}$**

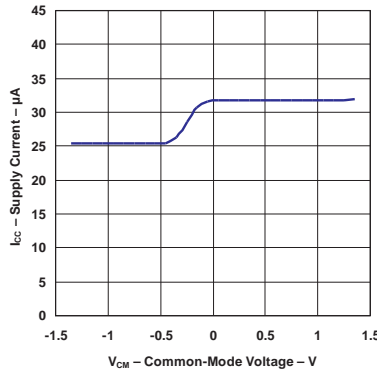

**SUPPLY CURRENT  
VS  
COMMON-MODE VOLTAGE  
 $V_{CC} = \pm 0.9\text{ V}$**

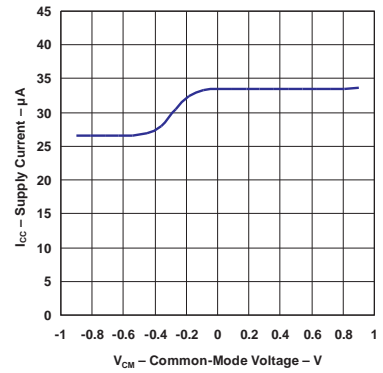

**PROPAGATION DELAY TIME,  
HIGH TO LOW  
 $V_{CC} = 5\text{ V}$**

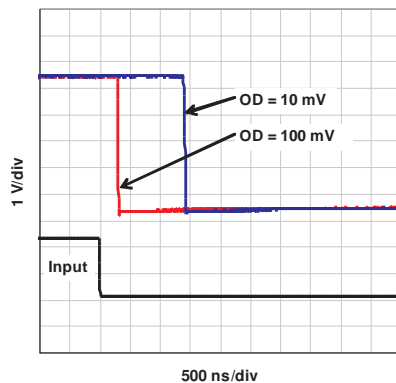

**PROPAGATION DELAY TIME,  
HIGH TO LOW  
 $V_{CC} = 2.7\text{ V}$**

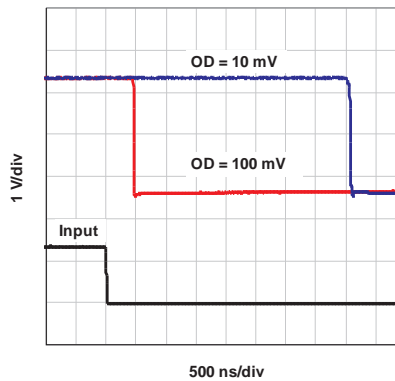

**PROPAGATION DELAY TIME,  
HIGH TO LOW  
 $V_{CC} = 1.8\text{ V}$**

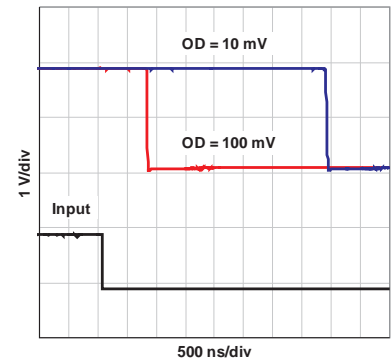

## TYPICAL CHARACTERISTICS (continued)

PROPAGATION DELAY TIME,  
LOW TO HIGH  
 $V_{CC} = 5\text{ V}$

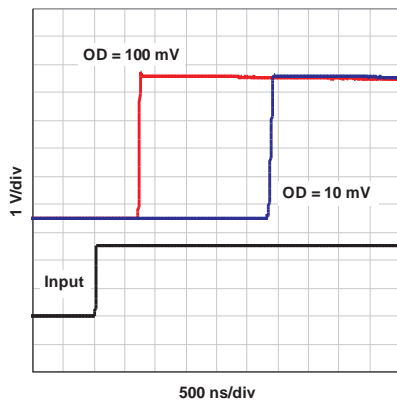

PROPAGATION DELAY TIME,  
LOW TO HIGH  
 $V_{CC} = 2.7\text{ V}$

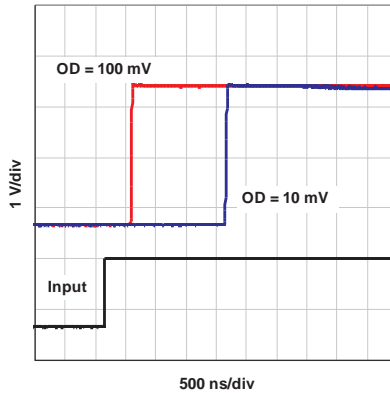

PROPAGATION DELAY TIME,  
LOW TO HIGH  
 $V_{CC} = 1.8\text{ V}$

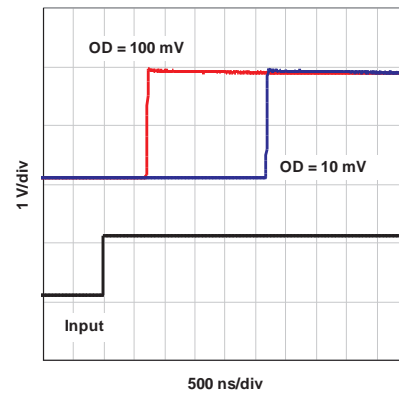



**PACKAGING INFORMATION**

Orderable Device	Status (1)	Package Type	Package Drawing	Pins	Package Qty	Eco Plan (2)	Lead/Ball Finish	MSL Peak Temp (3)	Op Temp (°C)	Top-Side Markings (4)	Samples
TLV7256IDDUR	ACTIVE	VSSOP	DDU	8	3000	Green (RoHS & no Sb/Br)	CU NIPDAU	Level-1-260C-UNLIM	-40 to 85	YAUA	<a href="#">Samples</a>
TLV7256IDDURG4	ACTIVE	VSSOP	DDU	8	3000	Green (RoHS & no Sb/Br)	CU NIPDAU	Level-1-260C-UNLIM	-40 to 85	YAUA	<a href="#">Samples</a>

(1) The marketing status values are defined as follows:

**ACTIVE:** Product device recommended for new designs.

**LIFEBUY:** TI has announced that the device will be discontinued, and a lifetime-buy period is in effect.

**NRND:** Not recommended for new designs. Device is in production to support existing customers, but TI does not recommend using this part in a new design.

**PREVIEW:** Device has been announced but is not in production. Samples may or may not be available.

**OBSOLETE:** TI has discontinued the production of the device.

(2) Eco Plan - The planned eco-friendly classification: Pb-Free (RoHS), Pb-Free (RoHS Exempt), or Green (RoHS & no Sb/Br) - please check <http://www.ti.com/productcontent> for the latest availability information and additional product content details.

**TBD:** The Pb-Free/Green conversion plan has not been defined.

**Pb-Free (RoHS):** TI's terms "Lead-Free" or "Pb-Free" mean semiconductor products that are compatible with the current RoHS requirements for all 6 substances, including the requirement that lead not exceed 0.1% by weight in homogeneous materials. Where designed to be soldered at high temperatures, TI Pb-Free products are suitable for use in specified lead-free processes.

**Pb-Free (RoHS Exempt):** This component has a RoHS exemption for either 1) lead-based flip-chip solder bumps used between the die and package, or 2) lead-based die adhesive used between the die and leadframe. The component is otherwise considered Pb-Free (RoHS compatible) as defined above.

**Green (RoHS & no Sb/Br):** TI defines "Green" to mean Pb-Free (RoHS compatible), and free of Bromine (Br) and Antimony (Sb) based flame retardants (Br or Sb do not exceed 0.1% by weight in homogeneous material)

(3) MSL, Peak Temp. -- The Moisture Sensitivity Level rating according to the JEDEC industry standard classifications, and peak solder temperature.

(4) Multiple Top-Side Markings will be inside parentheses. Only one Top-Side Marking contained in parentheses and separated by a "~" will appear on a device. If a line is indented then it is a continuation of the previous line and the two combined represent the entire Top-Side Marking for that device.

**Important Information and Disclaimer:** The information provided on this page represents TI's knowledge and belief as of the date that it is provided. TI bases its knowledge and belief on information provided by third parties, and makes no representation or warranty as to the accuracy of such information. Efforts are underway to better integrate information from third parties. TI has taken and continues to take reasonable steps to provide representative and accurate information but may not have conducted destructive testing or chemical analysis on incoming materials and chemicals. TI and TI suppliers consider certain information to be proprietary, and thus CAS numbers and other limited information may not be available for release.

In no event shall TI's liability arising out of such information exceed the total purchase price of the TI part(s) at issue in this document sold by TI to Customer on an annual basis.

**TAPE AND REEL INFORMATION**

**QUADRANT ASSIGNMENTS FOR PIN 1 ORIENTATION IN TAPE**

\*All dimensions are nominal

Device	Package Type	Package Drawing	Pins	SPQ	Reel Diameter (mm)	Reel Width W1 (mm)	A0 (mm)	B0 (mm)	K0 (mm)	P1 (mm)	W (mm)	Pin1 Quadrant
TLV7256IDDUR	VSSOP	DDU	8	3000	180.0	8.4	2.25	3.35	1.05	4.0	8.0	Q3

TAPE AND REEL BOX DIMENSIONS



\*All dimensions are nominal

Device	Package Type	Package Drawing	Pins	SPQ	Length (mm)	Width (mm)	Height (mm)
TLV7256IDDUR	VSSOP	DDU	8	3000	202.0	201.0	28.0

DDU (R-PDSO-G8)

PLASTIC SMALL-OUTLINE PACKAGE

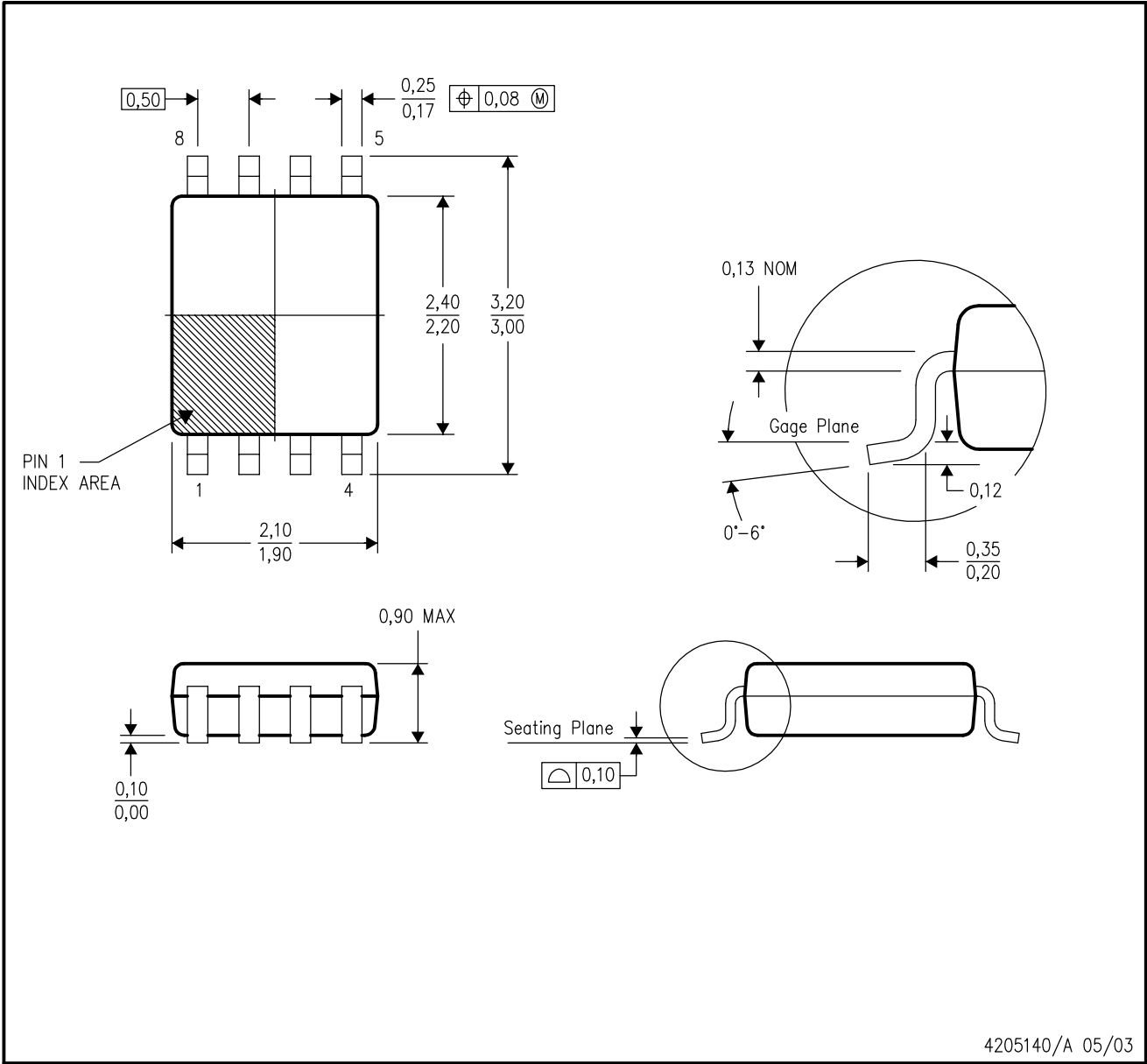

- NOTES:
- A. All linear dimensions are in millimeters.
  - B. This drawing is subject to change without notice.
  - C. Body dimensions do not include mold flash or protrusion.
  - D. Falls within JEDEC MO-187 variation CA.

DDU (S-PDSO-G8)

PLASTIC SMALL OUTLINE PACKAGE (DIE UP)

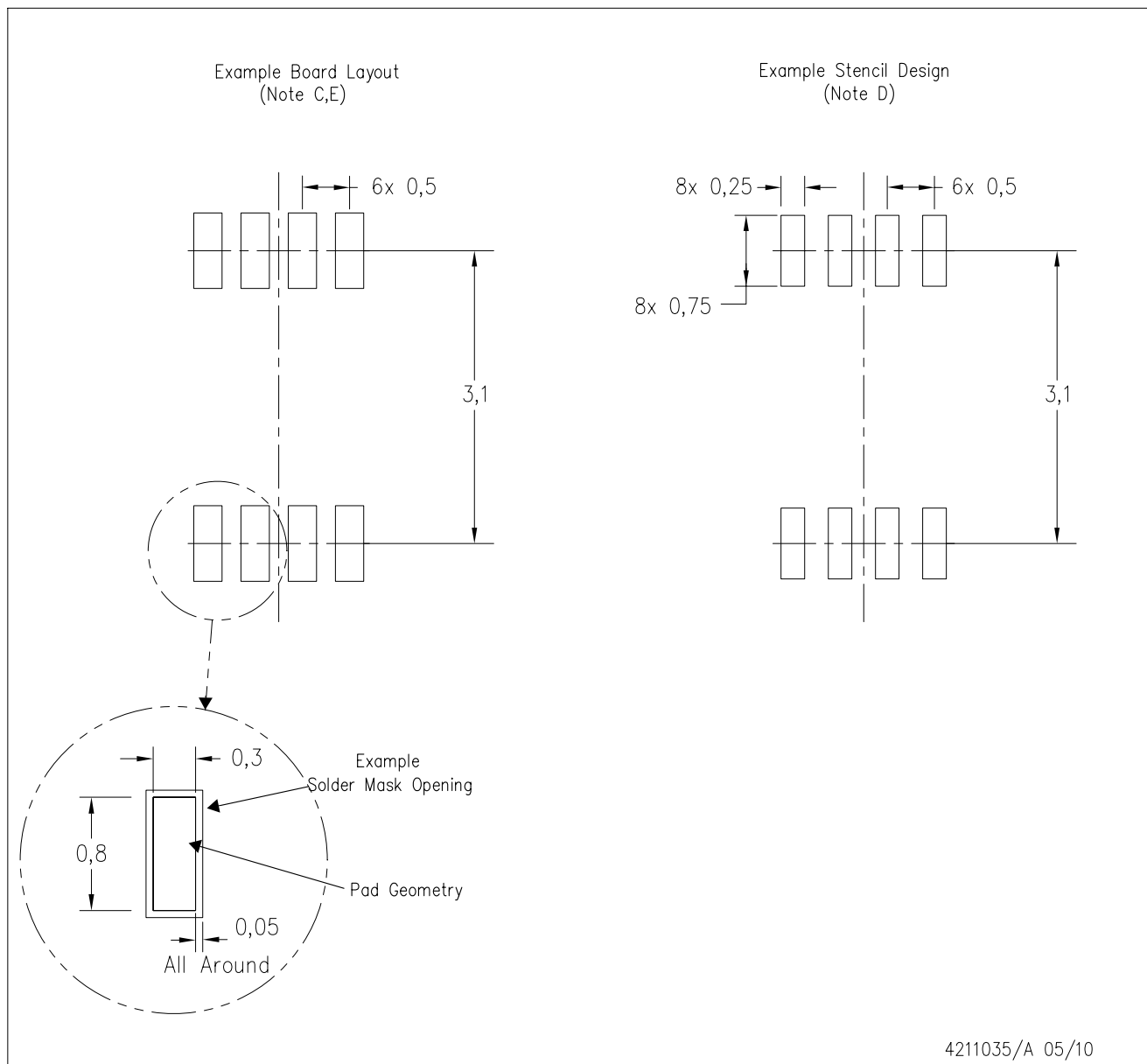

- NOTES:
- All linear dimensions are in millimeters.
  - This drawing is subject to change without notice.
  - Publication IPC-7351 is recommended for alternate designs.
  - Laser cutting apertures with trapezoidal walls and also rounding corners will offer better paste release. Customers should contact their board assembly site for stencil design recommendations. Refer to IPC-7525.
  - Customers should contact their board fabrication site for solder mask tolerances between and around signal pads.

## IMPORTANT NOTICE

Texas Instruments Incorporated and its subsidiaries (TI) reserve the right to make corrections, enhancements, improvements and other changes to its semiconductor products and services per JESD46, latest issue, and to discontinue any product or service per JESD48, latest issue. Buyers should obtain the latest relevant information before placing orders and should verify that such information is current and complete. All semiconductor products (also referred to herein as "components") are sold subject to TI's terms and conditions of sale supplied at the time of order acknowledgment.

TI warrants performance of its components to the specifications applicable at the time of sale, in accordance with the warranty in TI's terms and conditions of sale of semiconductor products. Testing and other quality control techniques are used to the extent TI deems necessary to support this warranty. Except where mandated by applicable law, testing of all parameters of each component is not necessarily performed.

TI assumes no liability for applications assistance or the design of Buyers' products. Buyers are responsible for their products and applications using TI components. To minimize the risks associated with Buyers' products and applications, Buyers should provide adequate design and operating safeguards.

TI does not warrant or represent that any license, either express or implied, is granted under any patent right, copyright, mask work right, or other intellectual property right relating to any combination, machine, or process in which TI components or services are used. Information published by TI regarding third-party products or services does not constitute a license to use such products or services or a warranty or endorsement thereof. Use of such information may require a license from a third party under the patents or other intellectual property of the third party, or a license from TI under the patents or other intellectual property of TI.

Reproduction of significant portions of TI information in TI data books or data sheets is permissible only if reproduction is without alteration and is accompanied by all associated warranties, conditions, limitations, and notices. TI is not responsible or liable for such altered documentation. Information of third parties may be subject to additional restrictions.

Resale of TI components or services with statements different from or beyond the parameters stated by TI for that component or service voids all express and any implied warranties for the associated TI component or service and is an unfair and deceptive business practice. TI is not responsible or liable for any such statements.

Buyer acknowledges and agrees that it is solely responsible for compliance with all legal, regulatory and safety-related requirements concerning its products, and any use of TI components in its applications, notwithstanding any applications-related information or support that may be provided by TI. Buyer represents and agrees that it has all the necessary expertise to create and implement safeguards which anticipate dangerous consequences of failures, monitor failures and their consequences, lessen the likelihood of failures that might cause harm and take appropriate remedial actions. Buyer will fully indemnify TI and its representatives against any damages arising out of the use of any TI components in safety-critical applications.

In some cases, TI components may be promoted specifically to facilitate safety-related applications. With such components, TI's goal is to help enable customers to design and create their own end-product solutions that meet applicable functional safety standards and requirements. Nonetheless, such components are subject to these terms.

No TI components are authorized for use in FDA Class III (or similar life-critical medical equipment) unless authorized officers of the parties have executed a special agreement specifically governing such use.

Only those TI components which TI has specifically designated as military grade or "enhanced plastic" are designed and intended for use in military/aerospace applications or environments. Buyer acknowledges and agrees that any military or aerospace use of TI components which have **not** been so designated is solely at the Buyer's risk, and that Buyer is solely responsible for compliance with all legal and regulatory requirements in connection with such use.

TI has specifically designated certain components as meeting ISO/TS16949 requirements, mainly for automotive use. In any case of use of non-designated products, TI will not be responsible for any failure to meet ISO/TS16949.

### Products

Audio	<a href="http://www.ti.com/audio">www.ti.com/audio</a>
Amplifiers	<a href="http://amplifier.ti.com">amplifier.ti.com</a>
Data Converters	<a href="http://dataconverter.ti.com">dataconverter.ti.com</a>
DLP® Products	<a href="http://www.dlp.com">www.dlp.com</a>
DSP	<a href="http://dsp.ti.com">dsp.ti.com</a>
Clocks and Timers	<a href="http://www.ti.com/clocks">www.ti.com/clocks</a>
Interface	<a href="http://interface.ti.com">interface.ti.com</a>
Logic	<a href="http://logic.ti.com">logic.ti.com</a>
Power Mgmt	<a href="http://power.ti.com">power.ti.com</a>
Microcontrollers	<a href="http://microcontroller.ti.com">microcontroller.ti.com</a>
RFID	<a href="http://www.ti-rfid.com">www.ti-rfid.com</a>
OMAP Applications Processors	<a href="http://www.ti.com/omap">www.ti.com/omap</a>
Wireless Connectivity	<a href="http://www.ti.com/wirelessconnectivity">www.ti.com/wirelessconnectivity</a>

### Applications

Automotive and Transportation	<a href="http://www.ti.com/automotive">www.ti.com/automotive</a>
Communications and Telecom	<a href="http://www.ti.com/communications">www.ti.com/communications</a>
Computers and Peripherals	<a href="http://www.ti.com/computers">www.ti.com/computers</a>
Consumer Electronics	<a href="http://www.ti.com/consumer-apps">www.ti.com/consumer-apps</a>
Energy and Lighting	<a href="http://www.ti.com/energy">www.ti.com/energy</a>
Industrial	<a href="http://www.ti.com/industrial">www.ti.com/industrial</a>
Medical	<a href="http://www.ti.com/medical">www.ti.com/medical</a>
Security	<a href="http://www.ti.com/security">www.ti.com/security</a>
Space, Avionics and Defense	<a href="http://www.ti.com/space-avionics-defense">www.ti.com/space-avionics-defense</a>
Video and Imaging	<a href="http://www.ti.com/video">www.ti.com/video</a>

### TI E2E Community

[e2e.ti.com](http://e2e.ti.com)