

DESIGNED FOR ACCURACY, BUILT FOR TRUST

VS1000 – DATASHEET

Single axis analog accelerometer

A new reference for low to medium frequency MEMS sensing

The new Colibrys VS1000 offers the best performance stability with shock resistance, as well as the lowest non-linearity and noise in the marketplace. Each product is fully tested and qualified to the highest Colibrys standards. It embeds a self-test function for your confidence at all time.



Functional Block Diagram

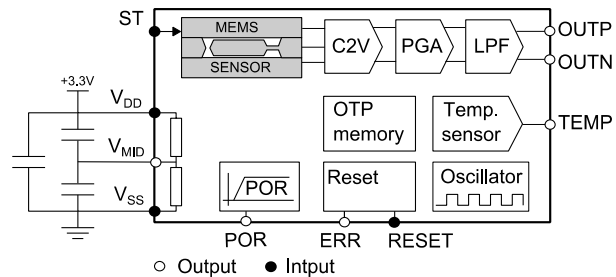

Key features

Parameter, typical values	VS1002	VS1005	VS1010	VS1030	VS1050	VS1100	VS1200	Unit
Full-scale acceleration	± 2	± 5	± 10	± 30	± 50	± 100	± 200	g
Frequency response (±5 %)	250	700	1'000	1'500	1'500	1'500	1'500	Hz
Non-linearity (full scale)	0.1	0.1	0.1	0.1	0.1	0.1	0.1	%
Noise (in band)	7	17	34	85	150	334	670	µg/√Hz
Scale factor (nominal)	1'350	540	270	90	54	27	13.5	mV/g
Scale factor temperature coefficient	120	120	120	120	120	120	120	ppm/°C
Bias temperature coefficient	±0.2	±0.5	±1	±3	±5	±10	±20	mg/°C
Shock Survivability	6'000	6'000	6'000	6'000	6'000	6'000	6'000	g

VS1002, VS1005, VS1010, VS1100 values to be confirmed as well as date of availability

Featured Applications (non-exhaustive)

Railway technology

- Active suspension system
- Active tilting system
- Bogie security monitoring
- Preventive maintenance
- Rolling stock fatigue analysis
- Track monitoring system
- Track geometry measuring system
- Vibration monitoring system

Testing

- Automotive testing (ride quality / durability, vehicle dynamics, ride & NVH, head rest vibration)
- Aero flight testing
- Aircraft carrier landing drop testing
- Down borehole testing
- Flutter testing
- Structure health testing (building, bridge, dam, nuclear plant)
- Wind tunnel

Process control

- Data loggers
- Drilling
- Early earthquake warning system
- MEMS inertial navigation system
- Structural Health Monitoring (SHM)
- Vibration monitoring (overload, vibration and shock)
- Wind turbine (monitor the gearbox and equipment)

Specifications

VS1030.A

All values are specified at ambient temperature (20°C) and at 3.3 V supply voltage V_{DD} , unless otherwise stated. Acceleration values are defined for differential signal (OUTP-OUTN).

Parameter	Comments	Min	Typ.	Max	Unit
Accelerometer					
Full scale		±30			g
Non linearity	% of full scale, under vibrations		0.1	0.3	%
Frequency response	±5%	1500			Hz
Noise	in band		85		µg/√Hz
Resonance frequency			4.2		kHz
Bias					
Calibration		-100		100	mg
Temperature coefficient	Measured at 3 temperatures [-40°C,+20°C,+85°C]	-3		3	mg/°C
Scale factor					
Calibration		88.5	90	91.5	mV/g
Temperature coefficient	Measured at 3 temperatures [-40°C,+20°C,+85°C]	-20	120	220	ppm/°C
Self-test					
Frequency	Square wave output	22	24.4	26.8	Hz
Duty cycle			50		%
Amplitude			0.5		g
Input threshold voltage	active high	80			% V_{DD}
Temperature sensor					
Output voltage @20°C		1.20	1.23	1.26	V
Sensitivity			-4.0		mV/°C
Output current load				10	µA
Output capacitive load				10	pF
Reset					
Input threshold voltage	active low			20	% V_{DD}
Power supply (V_{DD})					
Input voltage		3.2	3.3	3.4	V
Operating current consumption			3	4	mA
Startup time	Sensor operational, delay once POR triggered		40		µs
Accelerometer outputs					
Output voltages	OutP, OutN over full scale	0.15		3.15	V
Differential output	Over full scale		±2.7		V
Resistive load		1000			kΩ
Capacitive load				100	pF

Table 1: VS1030 specifications

VS1050.A

All values are specified at ambient temperature (20°C) and at 3.3 V supply voltage V_{DD} , unless otherwise stated. Acceleration values are defined for differential signal (OUTP-OUTN).

Parameter	Comments	Min	Typ.	Max	Unit
Accelerometer					
Full scale		±50			g
Non linearity	% of full scale, under vibrations		0.1	0.3	%
Frequency response	±5%	1500			Hz
Noise	in band		150		µg/√Hz
Resonance frequency			5.8		kHz
Bias					
Calibration		-170		170	mg
Temperature coefficient	Measured at 3 temperatures [-40°C,+20°C,+85°C]	-5		5	mg/°C
Scale factor					
Calibration		53	54	55	mV/g
Temperature coefficient	Measured at 3 temperatures [-40°C,+20°C,+85°C]	-20	120	220	ppm/°C
Self-test					
Frequency	Square wave output	22	24.4	26.8	Hz
Duty cycle			50		%
Amplitude			0.5		g
Input threshold voltage	active high	80			% V_{DD}
Temperature sensor					
Output voltage @20°C		1.20	1.23	1.26	V
Sensitivity			-4.0		mV/°C
Output current load				10	µA
Output capacitive load				10	pF
Reset					
Input threshold voltage	active low			20	% V_{DD}
Power supply (V_{DD})					
Input voltage		3.2	3.3	3.4	V
Operating current consumption			3	4	mA
Startup time	Sensor operational, delay once POR triggered		40		µs
Accelerometer outputs					
Output voltages	OutP, OutN over full scale	0.14		3.16	V
Differential output	Over full scale		±2.7		V
Resistive load		1000			kΩ
Capacitive load				100	pF

Table 2: VS1050 Specifications

VS1200.A

All values are specified at ambient temperature (20°C) and at 3.3 V supply voltage V_{DD} , unless otherwise stated. Acceleration values are defined for differential signal (OUTP-OUTN) and are validated at maximum $\pm 100g$ range.

Parameter	Comments	Min	Typ.	Max	Unit
Accelerometer					
Full scale		± 200			g
Non linearity	% of full scale, under vibrations		0.1	0.3	%
Frequency response	$\pm 5\%$	1500			Hz
Noise	in band		670		$\mu g/\sqrt{Hz}$
Resonance frequency			11		kHz
Bias					
Calibration		-700		700	mg
Temperature coefficient	Measured at 3 temperatures [-40°C,+20°C,+85°C]	-20		20	mg/°C
Scale factor					
Calibration		13.0	13.5	14.0	mV/g
Temperature coefficient	Measured at 3 temperatures [-40°C,+20°C,+85°C]	-20	120	220	ppm/°C
Self-test					
Frequency	Square wave output	22	24.4	26.8	Hz
Duty cycle			50		%
Amplitude			0.5		g
Input threshold voltage	active high	80			% V_{DD}
Temperature sensor					
Output voltage @20°C		1.20	1.23	1.26	V
Sensitivity			-4.0		mV/°C
Output current load				10	μA
Output capacitive load				10	pF
Reset					
Input threshold voltage	active low			20	% V_{DD}
Power supply (V_{DD})					
Input voltage		3.2	3.3	3.4	V
Operating current consumption			3	4	mA
Startup time	Sensor operational, delay once POR triggered		40		μs
Accelerometer outputs					
Output voltages	OutP, OutN over full scale	0.10		3.20	V
Differential output	Over full scale		± 2.7		V
Resistive load		1000			k Ω
Capacitive load				100	pF

Table 3: VS1200 Specifications

Absolute maximum ratings

Absolute maximum ratings are stress ratings. Stresses in excess of these ratings can cause permanent damage to the device. Exposure of the device to the absolute maximum ratings for an extended period may degrade the device and affect its reliability.

Parameter	Comments	Min	Typ	Max	Unit
Supply voltage V_{DD}		-0.3		3.9	V
Voltage at any PIN		-0.3		$V_{DD} + 0.3$	V
Operational temperature	Minimum guaranteed			-55	°C
	Maximum guaranteed	+125			°C
Multiple Shock	Functional operation after 500 shocks (0.5ms / half-sine / any axis)			1'500	g
Shock Survivability	Single shock (non-repetitive) 0.15ms half-sine, in one direction (HA, PA or IA axes)			6'000	g
ESD stress	HBM model	-1		1	kV

Table 4: Absolute maximum ratings

Handling precautions

The VS1000 is packaged in a hermetic ceramic housing to protect the sensor from the ambient environment. However, poor handling of the product can induce damage to the hermetic seal or to the ceramic package made of brittle material (alumina). It can also induce internal damage to the MEMS accelerometer that may not be visible and cause electrical failure or reliability issues. Handle the component with caution: shocks, such as dropping the accelerometer on hard surface, may damage the product.

The component is susceptible to damage due to electrostatic discharge (ESD). Therefore, suitable precautions shall be employed during all phases of manufacturing, testing, packaging, shipment and handling. Accelerometer will be supplied in antistatic bag with ESD warning label and they should be left in this packaging until use. The following guidelines are recommended:

- Always manipulate the devices in an ESD-controlled environment
- Always store the devices in a shielded environment that protects against ESD damage (at minimum an ESD-safe tray and an antistatic bag)
- Always wear a wrist strap when handling the devices and use ESD-safe gloves



This product can be damaged by electrostatic discharge (ESD). Handle with appropriate precautions.

SMD

The VS1000 is RoHS-compliant, suitable for lead-free soldering and SMD mounting. It must be tightly fixed to the PCB, using the bottom of the housing as the reference plane to ensure an input axis alignment. The stresses induced by soldering of the LCC package are of special concern for MEMS transducers, especially for high-end capacitive sensors like the VS1000 accelerometers. In order to obtain good stress homogeneity and the best long-term stability, all metal pads of the accelerometer must be soldered to the PCB. See the Colibrys application note "LCC soldering conditions" available on our web site.



Note: Ultrasonic cleaning must be avoided in order to avoid damage to the MEMS accelerometer

Pin description

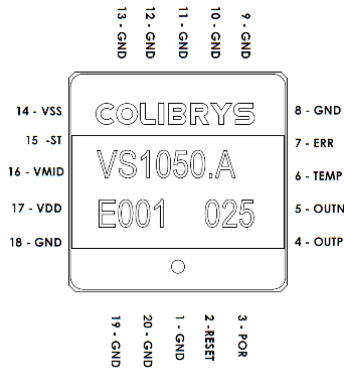

Figure 1: Pinout top view

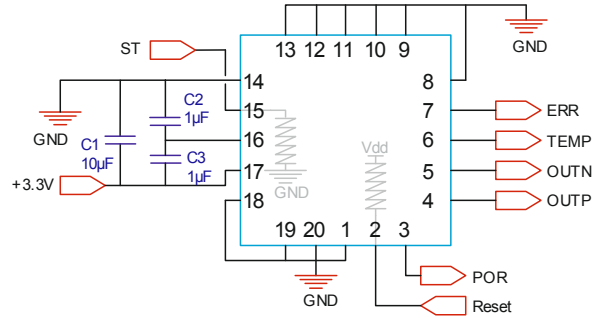

Figure 2: Proximity circuit & pull-up/down

The device pin layout is given in Figure 1 and a description of each pin given in the Table 5. The capacitors C1 (10 µF), C2 (1 µF) and C3 (1 µF) are shown in Figure 2 and must be placed as close as possible to the VS1000 package and are used as decoupling capacitors and for a proper sensor startup. COG or X7R capacitors @ 5 % are recommended.

Pin Nb.	Pin name	Type	Description
2	RESET	DI, PU	System reset signal, active low
3	POR	DO	Power On Reset
4	OUTP	AO	Differential output positive signal
5	OUTN	AO	Differential output negative signal
6	TEMP	AO	Temperature analogue output
7	ERR	DO	Error signal (flag)
14	V _{SS} (0 V)	PWR	Connect to ground plane
15	ST	DI, PD	Self-test activation, active high
16	V _{MID}	AO	Internal ASIC reference voltage. For decoupling capacitors only
17	V _{DD} (3.3 V)	PWR	Analogue power supply
1,8,9,10,11,12,13,18,19,20	GND	GND	Must be connected to ground plane (GND)

PWR, power / AO, analog output / AI, analog input / DO, digital output / DI, digital input / PD, internal pull down / PU, internal pull up

Table 5: VS1000 pinout description

POR (Power-On-Reset) function

The POR block continuously monitors the power supply during startup as well as normal operation. It ensures a proper startup of the sensor and acts as a brownout protection in case of a drop in supply voltage.

During sensor power on, the POR signal stays low until the supply voltage reaches the POR threshold voltage (V_{TH}) and begins the startup sequence (see Figure 3). In case of a supply voltage drop, the POR signal will stay low until the supply voltage exceeds V_{TH} and is followed by a new startup sequence. The ERR signal is high (equal to V_{DD}) until the startup sequence is complete.

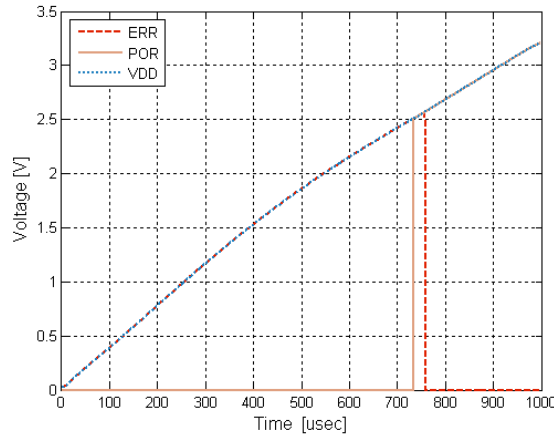

Figure 3: Typical sensor power sequence using the recommended circuit

External Reset

An external reset can be activated by the user through the RESET input pin. During a reset phase, the accelerometer outputs (OUTP & OUTN) are forced to $V_{DD} / 2$ and the error signal (ERR) is activated (high), see Figure 4.

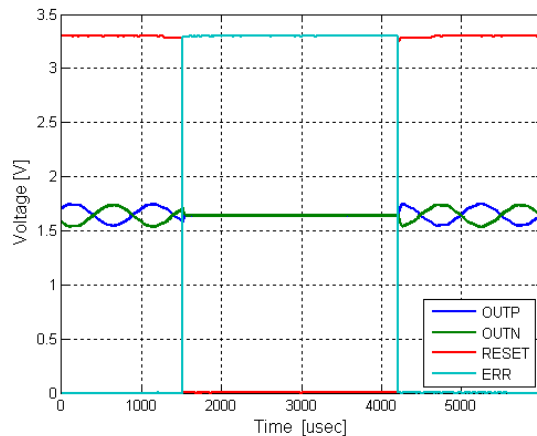

Figure 4: Typical sensor reset sequence with external reset

Built-in self-Test function

The built-in Self-Test mode generates a square wave signal on the device outputs (OUTP & OUTN) and can be used for device failure detection (see Figure 5).

When activated, it induces an alternating electrostatic force on the mechanical sensing element and emulates an input acceleration at a defined frequency. This electrostatic force is in addition to any inertial acceleration acting on the sensor during self-test; therefore it is recommended to use the self-test function under quiescent conditions.

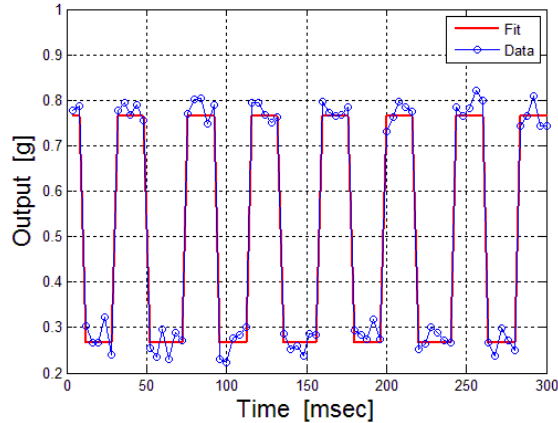

Figure 5: Built-in Self-test signal on the differential acceleration output (frequency: 24 Hz / amplitude 0.5 g)

Overload and error function

The device continuously monitors the validity of the accelerometer output signals. If an error occurs, the ERR pin goes high and informs the user that the output signals are not valid. An error can be raised in the following cases:

- Out of tolerance power supply (POR low), such as during power on
- During external reset phase (user activation of the reset)
- Temperature overload (if temperature is higher than the specification)
- Under high acceleration overload (e.g. high shock)

Upon a high-amplitude shock, the internal overload circuit resets the electronics and initiates a new startup of the readout electronics. This sequence is repeated until the acceleration input signal returns to normal operation range. This behavior is illustrated on the Figure 6 with a large shock of amplitude 1’500 g and 500 μs duration.

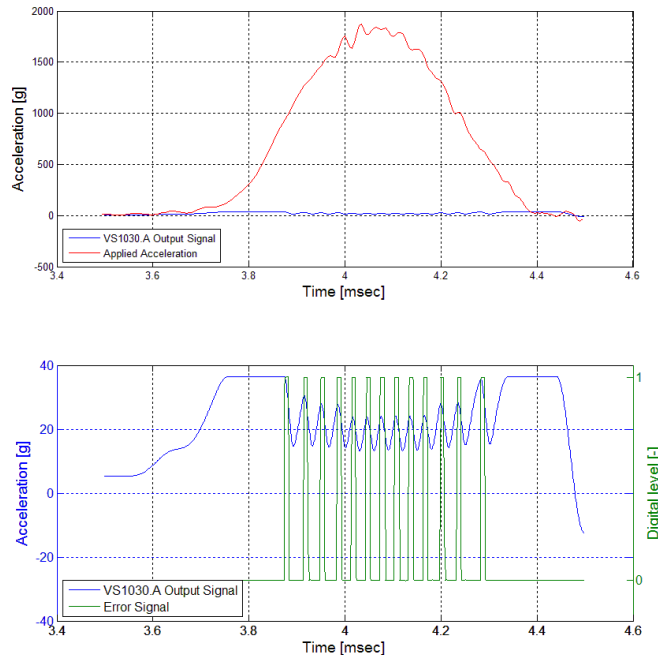

Figure 6: Accelerometer submitted to a 1’500 g / 0.5 ms shock. The overload protection is active during the shock and the sensor is fully operational once the acceleration is within the operating range.

Dimensions

The packaging is a standard LCC ceramic housing with a total of 20 pins

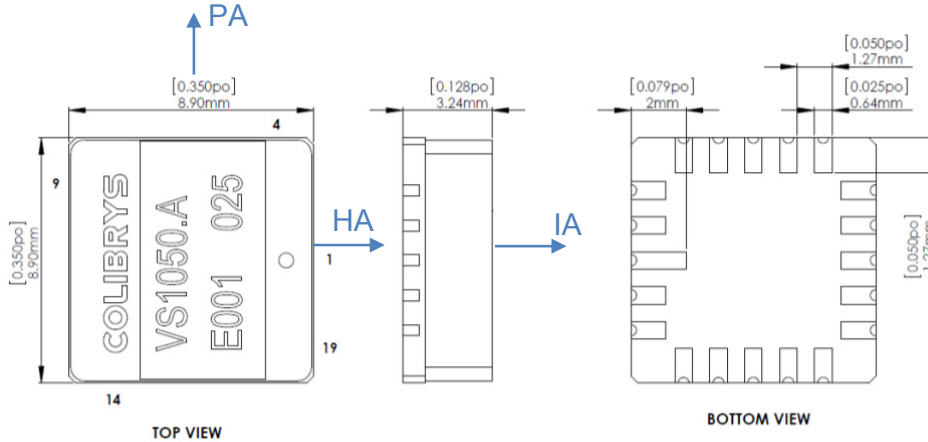

Figure 7: Package mechanical dimension

Parameter	Comments	Min	Typ	Max	Unit
Lead finishing	Au plating	0.5		1.5	µm
	Ni plating	1.27	4	8.89	µm
	W (tungsten)	10		15	µm
Hermeticity	According to MIL-STD-833-G			5·10 ⁻⁸	atm·cm ³ /s
Weight				1.5	grams
Size	X		8.9	9.2	mm
	Y		8.9	9.2	mm
	Z		3.23	3.5	mm
Packaging	RoHS compliant part. Nonmagnetic, LCC, 20 pin housing.				
Proximity effect	The sensor is sensitive to external parasitic capacitance. Moving metallic objects with large mass or parasitic effect in close proximity of the accelerometer (mm range) must be avoided to insure best product performances. A ground plane below the accelerometer is recommended as a shielding.				
Reference plane for axis alignment	LCC must be tightly fixed to the PCB, using the bottom of the housing as the reference plane for axis alignment. Using the lid as reference plane or for assembly may affect specifications and product reliability (i.e. axis alignment and/or lid soldering integrity)				

Table 6: Package specifications

Typical characteristics

VS1030.A

3.3 VDC supply voltage (V_{DD}) and ambient temperature for all graphs, unless otherwise stated

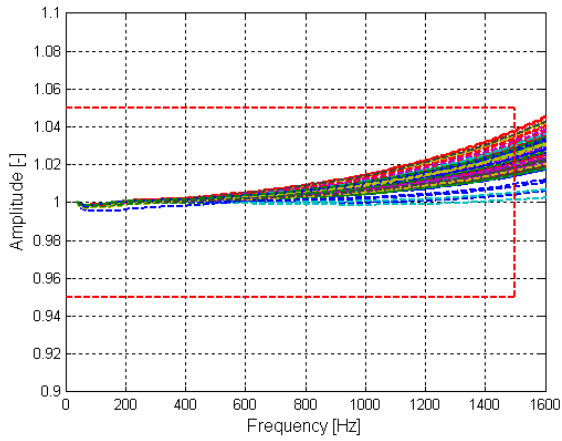

Figure 8: Typical frequency response

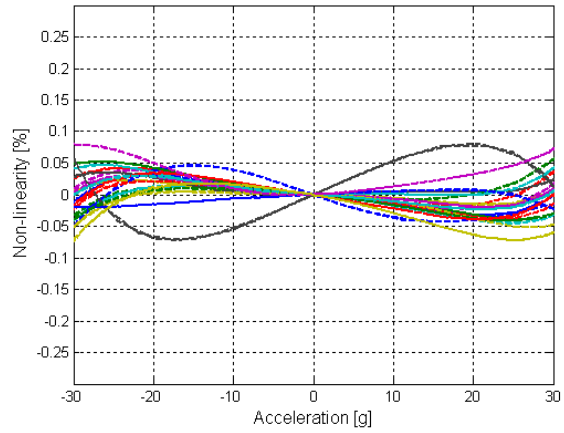

Figure 9 : Non linearity under vibration

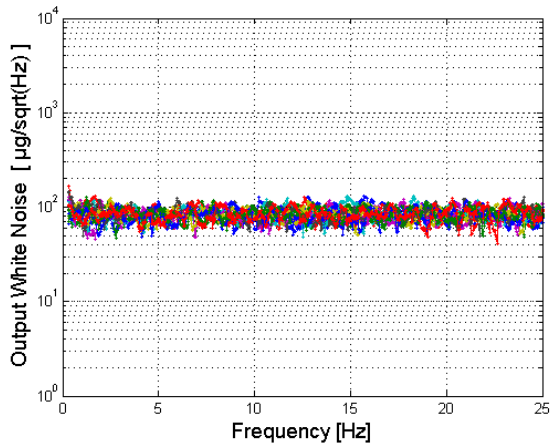

Figure 10: typical white noise

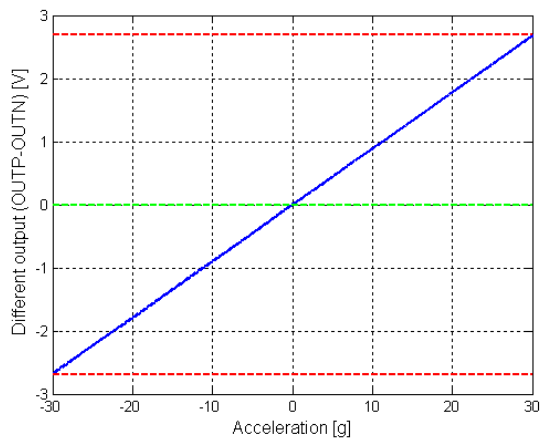

Figure 11: Differential acceleration output (OUTP-OUTN) at full scale

VS1050.A

3.3 VDC supply voltage (V_{DD}) and ambient temperature for all graphs, unless otherwise stated

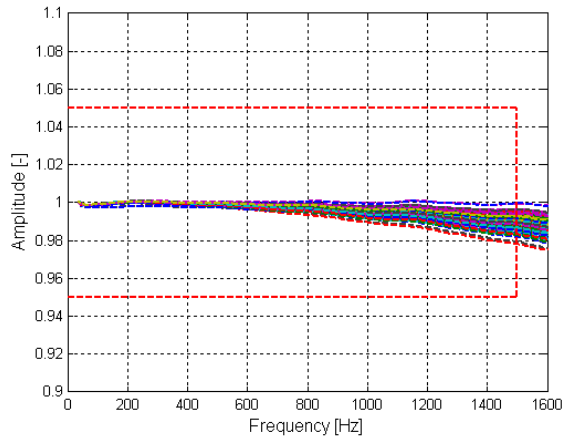

Figure 12: Typical frequency response

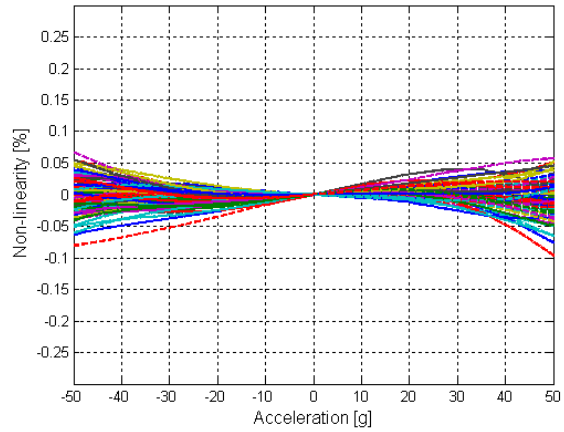

Figure 13 : Non linearity under vibration

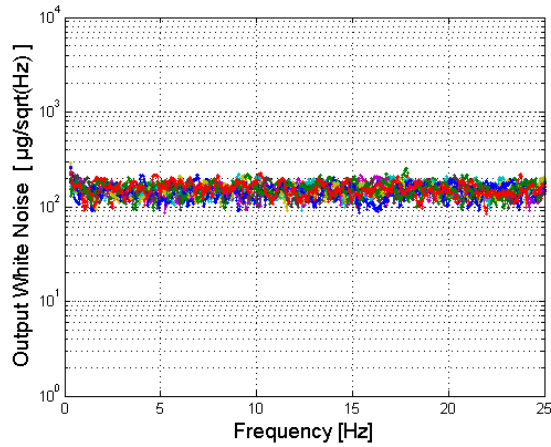

Figure 14: typical white noise

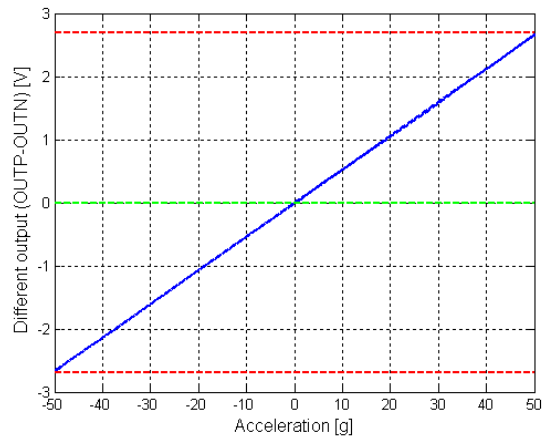

Figure 15: Differential acceleration output (OUTP-OUTN) at full scale

VS1200.A

3.3 VDC supply voltage (V_{DD}) and ambient temperature for all graphs, unless otherwise stated

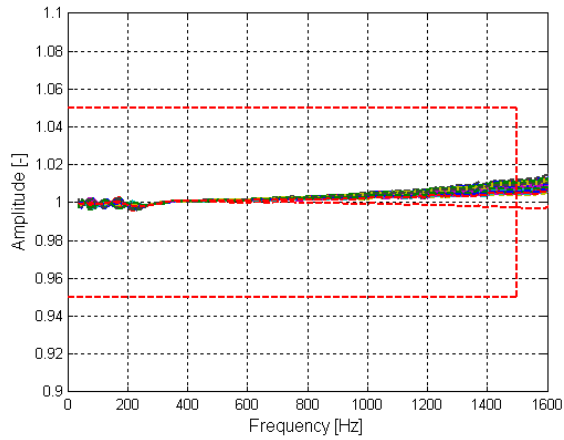

Figure 16: Typical frequency response

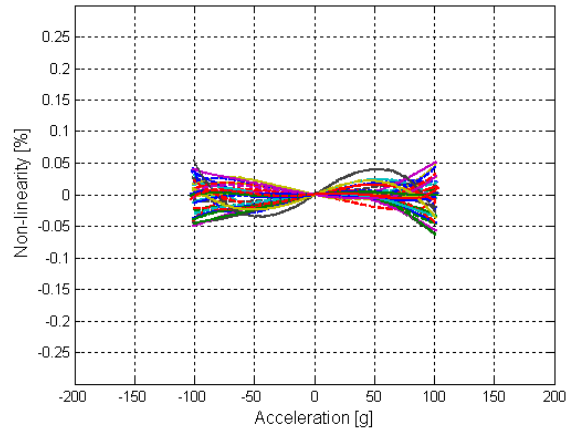

Figure 17 : Non linearity under vibration

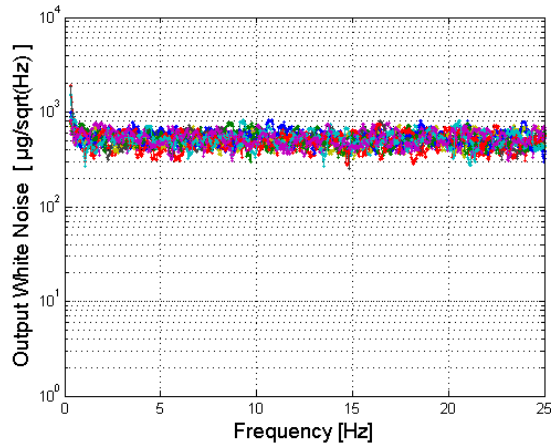

Figure 18: typical white noise

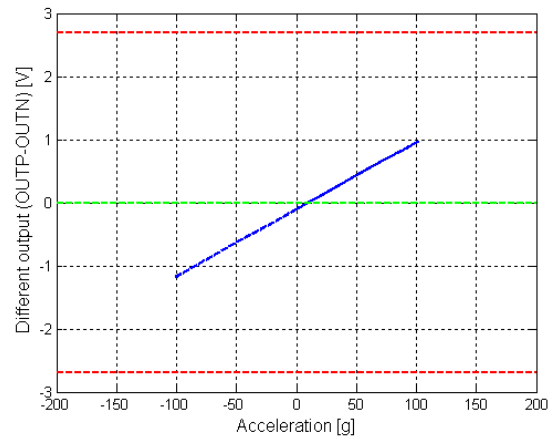

Figure 19: Differential acceleration output (OUTP-OUTN) at half full scale

Recommended circuit

In order to obtain the best device performance, particular attention must be paid to the proximity analog electronics. A proposed circuit that includes a reference voltage, the sensor decoupling capacitors and output buffers is described in Figure 20.

Optimal acceleration measurements are obtained using the differential output ($OUTP_B - OUTN_B$). If a single-ended acceleration signal is required, it must be generated from the differential acceleration output in order to remove the common mode noise.

Block Diagram & Schematic

The main blocks that require particular attention are the power supply management, the accelerometer sensor electronic and the output buffer. The following schematic shows an example of VS1000 implementation.

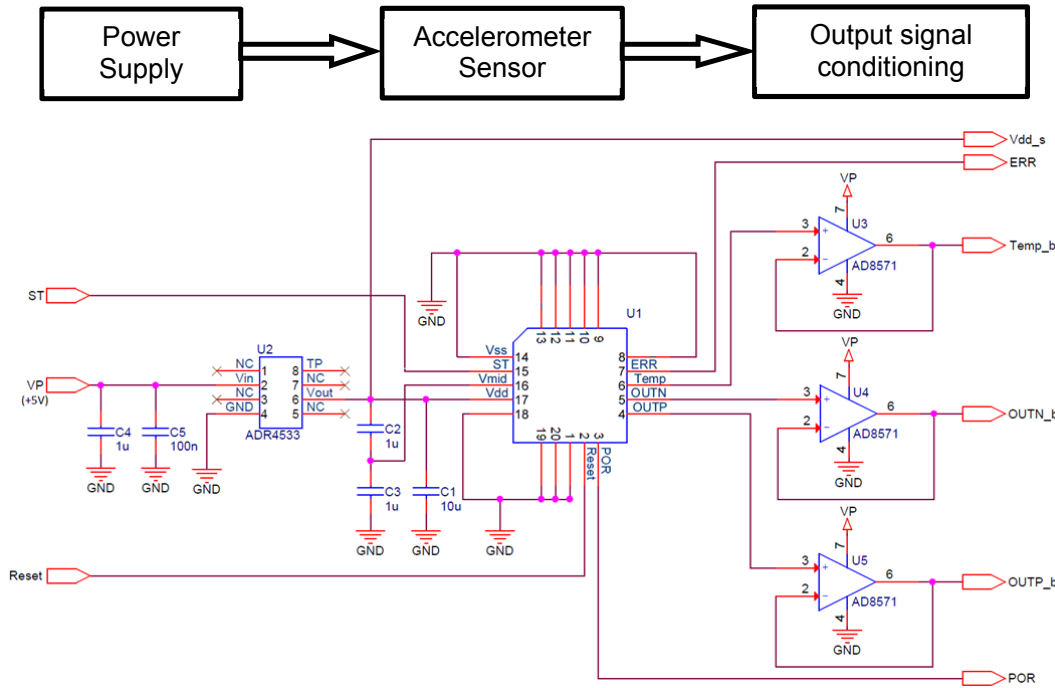

Figure 20: Recommended circuit

Power Supply

The accelerometer output is ratiometric to the power supply voltage and its performance will directly impact the accelerometer bias, scale factor, noise or thermal performance. Therefore, a low-noise, high-stability and low-thermal drift power supply is recommended. Key performance should be:

- Output noise < 1µV/√Hz
- Output temperature coefficient < 10ppm/°C

The power supply can be used as an output signal ($V_{DD,S}$) in order to compensate any variation on the power supply voltage that will impact the accelerometer signal (ratiometric output).

The electronic circuit within the accelerometer is based on a switched-capacitor architecture clocked @ 200 KHz. High-frequency noise or spikes on the power supply will affect the outputs and induce a signal within the device bandwidth.

Accelerometer sensor

The sensor block is composed of the VS1000 accelerometer and the 3 decoupling capacitors: C1, C2 and C3. These capacitors are mandatory for the proper operation and full performance of the accelerometer. We recommend placing them as close as possible to the VS1000 package on the printed circuit board.

Output signal conditioning

The output buffer must be correctly selected in order match the VS1000 output impedance and signal bandwidth. The AD8571 is proposed for the acceleration output (OUTP & OUTN) and the temperature output (TEMP).

Glossary of parameters of the Data Sheet

g [m/s²]

Unit of acceleration, equal to standard value of the earth gravity (Accelerometer specifications and data supplied by Colibrys use 9.80665 m/s²).

Bias [mg]

The accelerometer output at zero g.

Bias temperature coefficient [mg/°C]

Variation of the bias under variable external temperature conditions (slope of the best fit straight line through the curve of bias vs. temperature).

Scale factor [mV/g]

The ratio of the change in output (in volts) to a unit change of the input (in units of acceleration); thus given in mV/g.

Scale factor temperature coefficient [ppm/°C]

Maximum deviation of the scale factor under variable external temperature conditions.

Temperature sensitivity

Sensitivity of a given performance characteristic (typically scale factor, bias, or axis misalignment) to operating temperature, specified generally at 20°C. Expressed as the change of the characteristic per degree of temperature change; a signed quantity, typically in ppm/°C for scale factor and mg/°C for bias. This figure is useful for predicting maximum scale factor error with temperature, as a variable when modelling is not accomplished.

Non-linearity [% FS]

The maximum deviation of accelerometer output from the best linear fit over the full scale input acceleration. The deviation is expressed as a percentage of the full-scale output (+A_{FS}).

Frequency response [Hz]

Frequency range from DC to the specified value where the variation in the frequency response amplitude is less than -3 dB (or -5 % for vibration sensors).

Resonance frequency [kHz]

Typical resonance frequency of the mounted device.

Noise [µg/√Hz]

Undesired perturbations in the accelerometer output signal, which are generally uncorrelated with desired or anticipated input accelerations.

Axes definition

Input Axis (IA): sensitive axis

Pendulous Axis (PA): Aligned with the proof mass beam and perpendicular to the input axis

Hinge Axis (HA): Perpendicular to the input and pendulous axes

Quality

Colibrys is ISO 9001:2008, ISO 14001:2004 and OHSAS 18001:2007 certified

Colibrys is in compliant with the European Community Regulation on chemicals and their safe use (EC 1907/2006) REACH.

VS1000 products comply with the EU-RoHS directive 2011/65/EC (Restrictions on hazardous substances) regulations

Recycling : please use appropriate recycling process for electrical and electronic components (DEEE)

VS1000 products are compliant with the Swiss LSPro : 930.11 dedicated to the security of products

Note:

- *VS1000 accelerometers are available for sales to professional only*
- *Les accéléromètres VS1000 ne sont disponibles à la vente que pour des clients professionnels*
- *Die Produkte der Serie VS1000 sind nur im Vertrieb für kommerzielle Kunden verfügbar*
- *Gli accelerometri VS1000 sono disponibili alla vendita soltanto per clienti professionisti*

Colibrys complies with due diligence requirements of Section 1502, Conflict Minerals, of the US Dodd-Frank Wall Street Reform and Consumer Protection Act and follows latest standard EICC/GeSI templates for Conflict Material declaration

