

NCS333, NCS2333, NCS4333

10 μV Offset, 0.07 $\mu\text{V}/^\circ\text{C}$, Low Power, Zero-Drift Operational Amplifier

The NCS333 family of high precision op amps feature very low input offset voltage (10 μV max) and near-zero drift over time and temperature. These low quiescent current amplifiers have high impedance inputs with a common-mode range 100 mV beyond the rails as well as rail-to-rail output swing within 50 mV of the rails. These op amps operate over a wide supply range from 1.8 V to 5.5 V. The NCS333 family exhibits outstanding CMRR without the crossover associated with traditional complementary input stages. The NCS333, as well as the dual version, NCS2333, and the quad version, NCS4333, come in a variety of packages and pinouts.

Features

- Low Offset Voltage: 10 μV max
- Zero Drift: 0.07 $\mu\text{V}/^\circ\text{C}$ max
- Low Noise: 1.1 μVpp , 0.1 Hz to 10 Hz
- Quiescent Current per Channel: 17 μA Typical at 3.3 V Supply
- Supply Voltage: 1.8 V to 5.5 V
- Rail-to-Rail Input and Output
- NCV Prefix for Automotive and Other Applications Requiring Unique Site and Control Change Requirements; AEC-Q100 Qualified and PPAP Capable
- These Devices are Pb-Free, Halogen Free/BFR Free and are RoHS Compliant

Typical Applications

- Temperature Measurements
- Transducer Applications
- Current Sensing

End Products

- Battery Powered Instruments
- Electronic Scales
- Medical Instrumentation

This document contains information on some products that are still under development. ON Semiconductor reserves the right to change or discontinue these products without notice.



ON Semiconductor®

<http://onsemi.com>



SOT23-5
SN SUFFIX
CASE 483



SC70-5
SQ SUFFIX
CASE 419A



DFN-8
TBD SUFFIX
CASE 506BW



MSOP-8
DM SUFFIX
CASE 846AH



SOIC-8
D SUFFIX
CASE 751

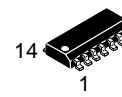

SOIC-14
D SUFFIX
CASE 751A

DEVICE MARKING INFORMATION

See general marking information in the device marking section on page 2 of this data sheet.

ORDERING INFORMATION

See detailed ordering and shipping information on page 3 of this data sheet.

NCS333, NCS2333, NCS4333

DEVICE MARKING INFORMATION

Single Channel Configuration NCS333, NCV333

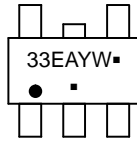

TSOP-5/SOT23-5
CASE 483

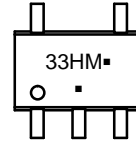

SC70-5
CASE 419A

Dual Channel Configuration NCS2333, NCV2333

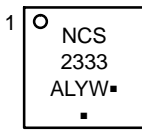

DFN8, 3x3, 0.65P
CASE 506BW

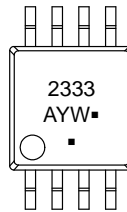

Micro8/MSOP8
CASE 846AH

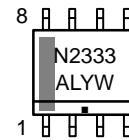

SOIC-8
CASE 751

Quad Channel Configuration NCS4333, NCV4333

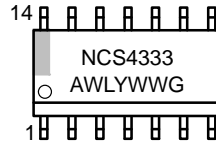

SOIC-14
CASE 751A

- 33E = Specific Device Code (SOT23-5)
- 33H = Specific Device Code (SC70-5)
- A = Assembly Location
- Y = Year
- W = Work Week
- M = Date Code
- G or ■ = Pb-Free Package

(Note: Microdot may be in either location)

NCS333, NCS2333, NCS4333

PIN CONNECTIONS

Single Channel Configuration NCS333, NCV333

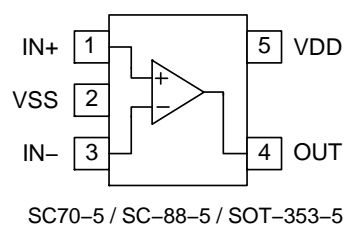
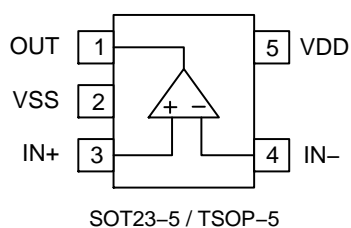

Dual Channel Configuration NCS2333, NCV2333

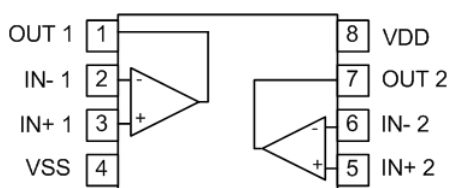

Quad Channel Configuration NCS4333, NCV4333

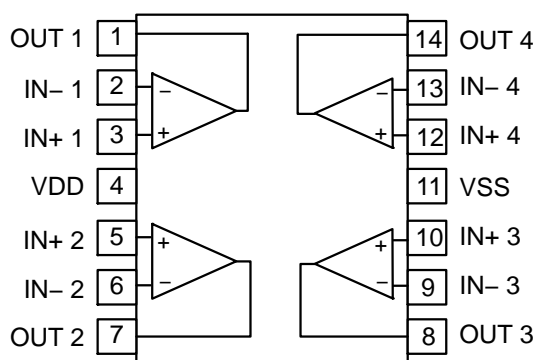

ORDERING INFORMATION

Configuration	Automotive	Device	Package	Shipping †
Single	No	NCS333SN2T1G	SOT23-5 / TSOP-5	3000 / Tape & Reel
		NCS333SQ3T2G	SC70-5 / SC-88-5 / SOT-353-5	3000 / Tape & Reel
	Yes	NCV333SN2T1G* (In Development)	SOT23-5 / TSOP-5	3000 / Tape & Reel
Dual	No	NCS2333MNTXG* (In Development)	DFN8	3000 / Tape & Reel
		NCS2333DR2G* (In Development)	SOIC-8	2500 / Tape & Reel
		NCS2333DMR2G* (In Development)	MICRO-8	4000 / Tape & Reel
	Yes	NCV2333DR2G* (In Development)	SOIC-8	2500 / Tape & Reel
		NCV2333DMR2G* (In Development)	MICRO-8	4000 / Tape & Reel
Quad	No	NCS4333DR2G* (In Development)	SOIC-14	2500 / Tape & Reel
	Yes	NCV4333DR2G* (In Development)	SOIC-14	2500 / Tape & Reel

†For information on tape and reel specifications, including part orientation and tape sizes, please refer to our Tape and Reel Packaging Specifications Brochure, BRD8011/D.

*Contact local sales office for more information

NCS333, NCS2333, NCS4333

ABSOLUTE MAXIMUM RATINGS

Over operating free-air temperature, unless otherwise stated.

Parameter	Rating	Unit
Supply Voltage	7	V

INPUT AND OUTPUT PINS

Input Voltage (Note 1)	(VSS) – 0.3 to (VDD) + 0.3	V
Input Current (Note 1)	±10	mA
Output Short Circuit Current (Note 2)	Continuous	

TEMPERATURE

Operating Temperature	–40 to +125	°C
Storage Temperature	–65 to +150	°C
Junction Temperature	–65 to +150	°C

ESD RATINGS (Note 3)

Human Body Model (HBM)	4000	V
Machine Model (MM)	200	V

OTHER RATINGS

Latch-up Current (Note 4)	100	mA
MSL	Level 1	

Stresses exceeding those listed in the Maximum Ratings table may damage the device. If any of these limits are exceeded, device functionality should not be assumed, damage may occur and reliability may be affected.

- Input terminals are diode-clamped to the power-supply rails. Input signals that can swing more than 0.3 V beyond the supply rails should be current limited to 10 mA or less
- Short-circuit to ground.
- This device series incorporates ESD protection and is tested by the following methods:
ESD Human Body Model tested per AEC-Q100-002 (JEDEC standard: JESD22-A114)
ESD Machine Model tested per AEC-Q100-003 (JEDEC standard: JESD22-A115)
- Latch-up Current tested per JEDEC standard: JESD78.

THERMAL INFORMATION (Note 5)

Parameter	Symbol	Package	Value	Unit
Junction to Ambient	θ_{JA}	SOT23-5/ TSOP5	235	°C/W
		SC70-5 / SC-88-5 / SOT-353-5	250	
		Micro8/MSOP8	238	
		SOIC-8	190	
		DFN-8	70	
		SOIC-14	156	

- As mounted on an 80x80x1.5 mm FR4 PCB with 650 mm² and 2 oz (0.034 mm) thick copper heat spreader. Following JEDEC JESD/EIA 51.1, 51.2, 51.3 test guidelines

OPERATING CONDITIONS

Parameter	Symbol	Range	Unit	
Supply Voltage ($V_{DD} - V_{SS}$)	V_S	1.8 to 5.5	V	
Specified Operating Range	NCS prefix NCS prefix	T_A	–40 to 105	°C
			–40 to 125	
Input Common Mode Voltage Range	V_{ICMR}	$V_{SS}-0.1$ to $V_{DD}+0.1$	V	

Functional operation above the stresses listed in the Recommended Operating Ranges is not implied. Extended exposure to stresses beyond the Recommended Operating Ranges limits may affect device reliability.

NCS333, NCS2333, NCS4333

ELECTRICAL CHARACTERISTICS: $V_S = 1.8\text{ V to }5.5\text{ V}$

At $T_A = +25^\circ\text{C}$, $R_L = 10\text{ k}\Omega$ connected to midsupply, $V_{CM} = V_{OUT} = \text{midsupply}$, unless otherwise noted.

Boldface limits apply over the specified temperature range, $T_A = -40^\circ\text{C to }105^\circ\text{C}$ for NCS prefix and $T_A = -40^\circ\text{C to }125^\circ\text{C}$ for NCV prefix, guaranteed by characterization and/or design.

Parameter	Symbol	Conditions	Min	Typ	Max	Unit	
INPUT CHARACTERISTICS							
Offset Voltage	V_{OS}	$V_S = +5\text{ V}$		3.5	10	μV	
Offset Voltage Drift vs Temp	$\Delta V_{OS}/\Delta T$			0.03	0.07	$\mu\text{V}/^\circ\text{C}$	
Offset Voltage Drift vs Supply	$\Delta V_{OS}/\Delta V_S$	$V_S = 1.8\text{ V to }5.5\text{ V}$		0.32	5	$\mu\text{V}/\text{V}$	
Long-Term Stability				(Note 6)			
Input Bias Current	I_{IB}			± 60	± 200	pA	
				± 140			
Input Offset Current	I_{OS}			± 50	± 400	pA	
Common Mode Rejection Ratio	CMRR	$V_{SS} - 0.1 < V_{CM} < V_{DD} + 0.1$	$V_S = 1.8\text{ V}$		111		dB
			$V_S = 3.3\text{ V}$		118		
			$V_S = 5.0\text{ V}$	106	123		
			$V_S = 5.5\text{ V}$		127		
Input Resistance	R_{IN}	Differential		180		$\text{G}\Omega$	
		Common Mode		90			
Input Capacitance	C_{IN}	Differential		2.3		pF	
		Common Mode		4.6			

OUTPUT CHARACTERISTICS

Open Loop Voltage Gain	A_{VOL}	$V_{SS} + 100\text{ mV} < V_{CM} < V_{DD} - 100\text{ mV}$	106	145		dB
Open Loop Output Impedance	Z_{out-OL}	$f = 350\text{ kHz}$, $I_O = 0\text{ mA}$		300		Ω
Output Voltage High	V_{OH}	Referenced to V_{DD}		8	50	mV
					70	
Output Voltage Low	V_{OL}	Referenced to V_{SS}		5	50	mV
					70	
Output Current Capability	I_O	Sinking Current		25		mA
		Sourcing Current		6		
Capacitive Load Drive	C_L		See Figure 15			

NOISE PERFORMANCE

Voltage Noise Density	e_N	$f_{IN} = 1\text{ kHz}$		62		$\text{nV}/\sqrt{\text{Hz}}$
Voltage Noise	e_{P-P}	$f_{IN} = 0.1\text{ Hz to }10\text{ Hz}$		1.1		μV_{PP}
		$f_{IN} = 0.01\text{ Hz to }1\text{ Hz}$		0.5		
Current Noise Density	i_N	$f_{IN} = 10\text{ Hz}$		350		$\text{fA}/\sqrt{\text{Hz}}$

DYNAMIC PERFORMANCE

Gain Bandwidth Product	GBWP	$C_L = 100\text{ pF}$		350		kHz
Gain Margin	A_M	$C_L = 100\text{ pF}$		18		dB
Phase Margin	ϕ_M	$C_L = 100\text{ pF}$		55		$^\circ$
Slew Rate	SR	$G = +1$		0.1		$\text{V}/\mu\text{s}$

6. 300-hour life test at $+150^\circ\text{C}$ demonstrated randomly distributed variation of approximately $1\ \mu\text{V}$.

NCS333, NCS2333, NCS4333

ELECTRICAL CHARACTERISTICS: $V_S = 1.8\text{ V}$ to 5.5 V

At $T_A = +25^\circ\text{C}$, $R_L = 10\text{ k}\Omega$ connected to midsupply, $V_{CM} = V_{OUT} = \text{midsupply}$, unless otherwise noted.

Boldface limits apply over the specified temperature range, $T_A = -40^\circ\text{C}$ to 105°C for NCS prefix and $T_A = -40^\circ\text{C}$ to 125°C for NCV prefix, guaranteed by characterization and/or design.

Parameter	Symbol	Conditions	Min	Typ	Max	Unit	
POWER SUPPLY							
Power Supply Rejection Ratio	PSRR		106	130		dB	
Turn-on Time	t_{ON}	$V_S = 5\text{ V}$		20		μs	
Quiescent Current	I_Q	No load, per channel	$1.8\text{ V} \leq V_S \leq 3.3\text{ V}$		17	25	μA
						27	
		$3.3\text{ V} < V_S \leq 5.5\text{ V}$		21	33		
					35		

Product parametric performance is indicated in the Electrical Characteristics for the listed test conditions, unless otherwise noted. Product performance may not be indicated by the Electrical Characteristics if operated under different conditions.

TYPICAL CHARACTERISTICS

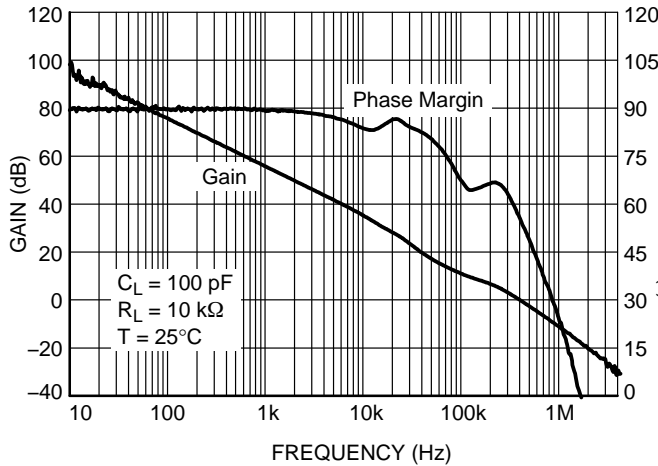

Figure 1. Open Loop Gain and Phase Margin vs. Frequency

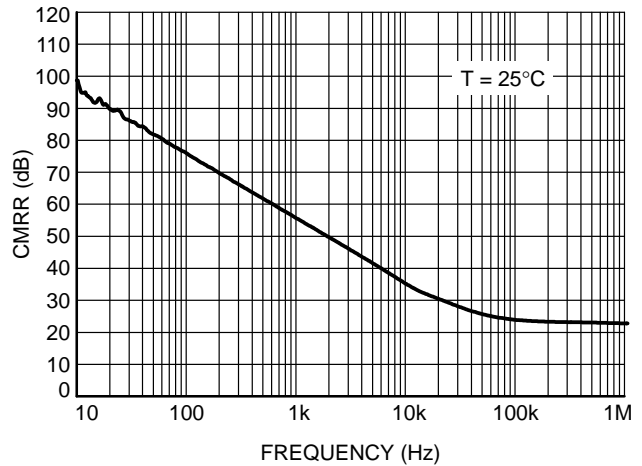

Figure 2. CMRR vs. Frequency

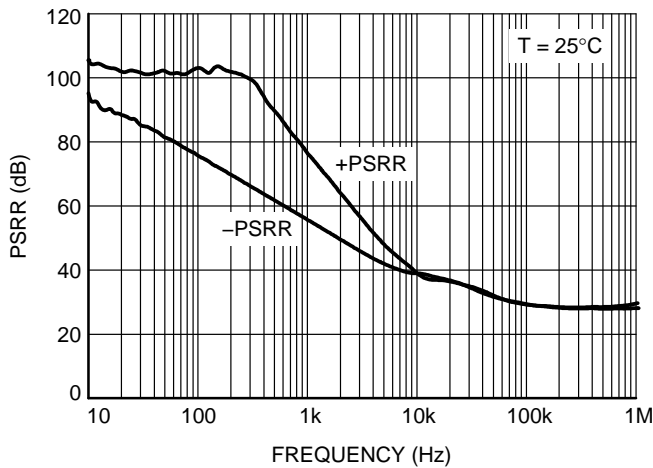

Figure 3. PSRR vs. Frequency

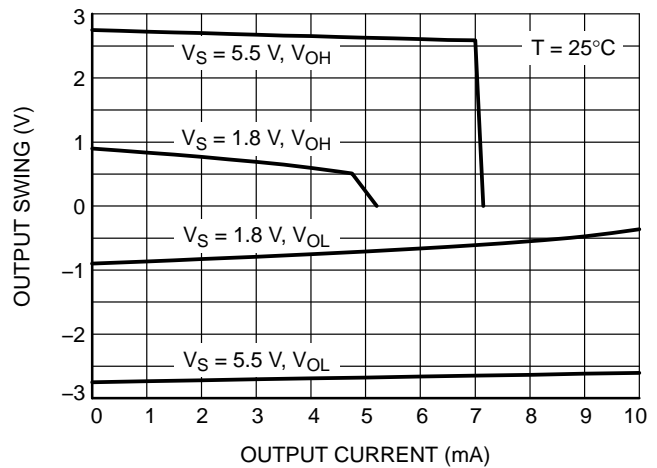

Figure 4. Output Voltage Swing vs. Output Current

TYPICAL CHARACTERISTICS

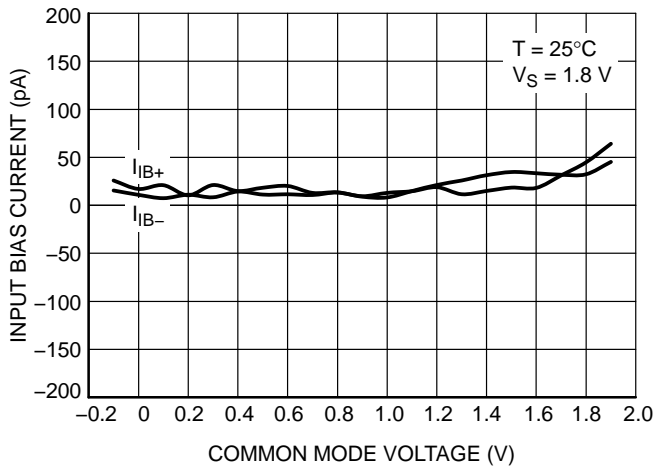

Figure 5. Input Bias Current vs. Common Mode Voltage

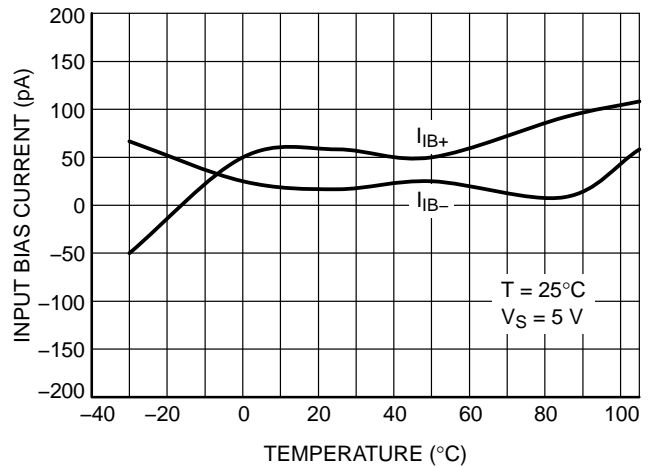

Figure 6. Input Bias Current vs. Temperature

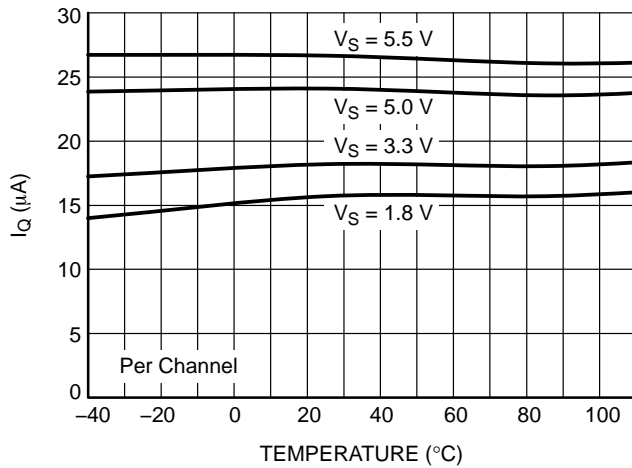

Figure 7. Quiescent Current vs. Temperature

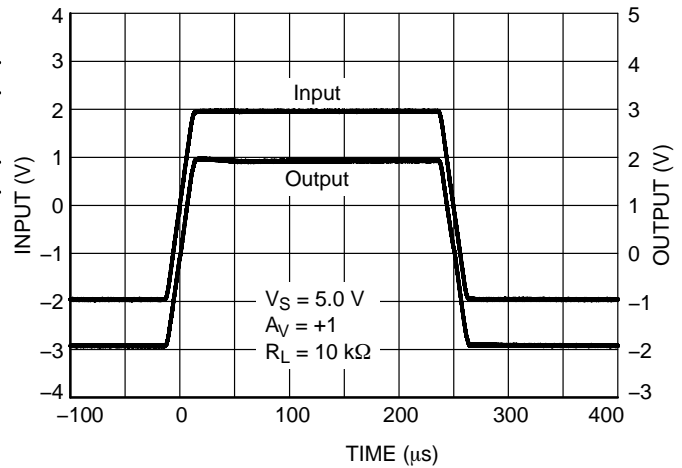

Figure 8. Large Signal Step Response

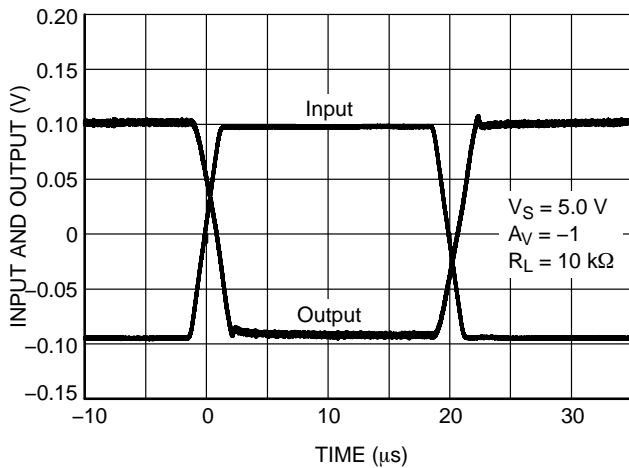

Figure 9. Small Signal Step Response

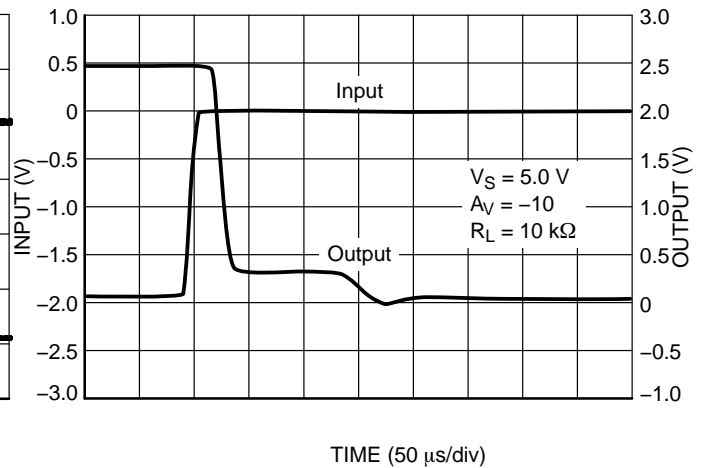

Figure 10. Positive Overtolerance Recovery

TYPICAL CHARACTERISTICS

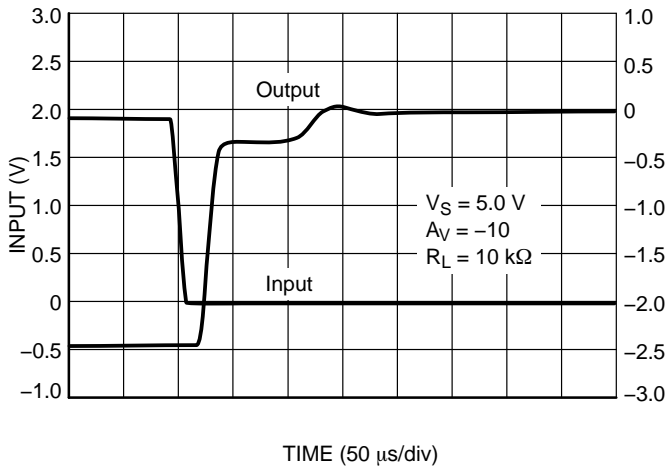

Figure 11. Negative Overtolerance Recovery

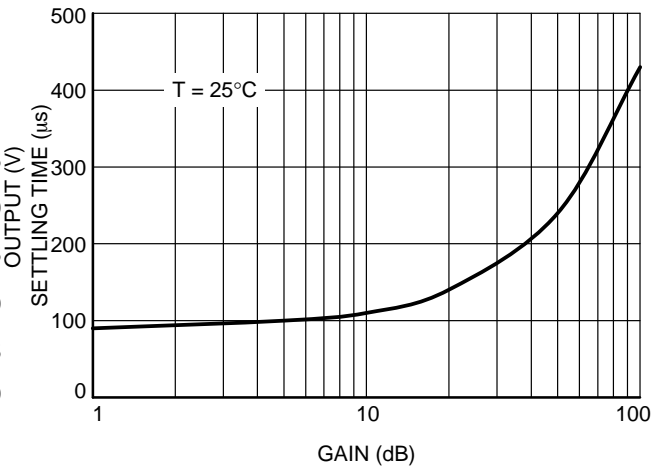

Figure 12. Setting Time vs. Closed-Loop Gain

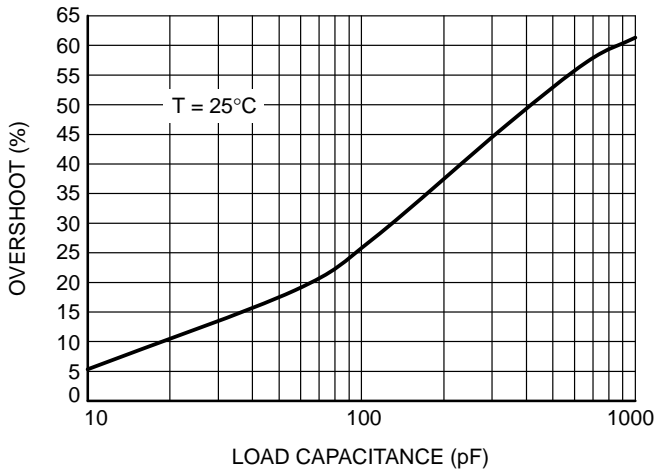

Figure 13. Small-Signal Overshoot vs. Load Capacitance

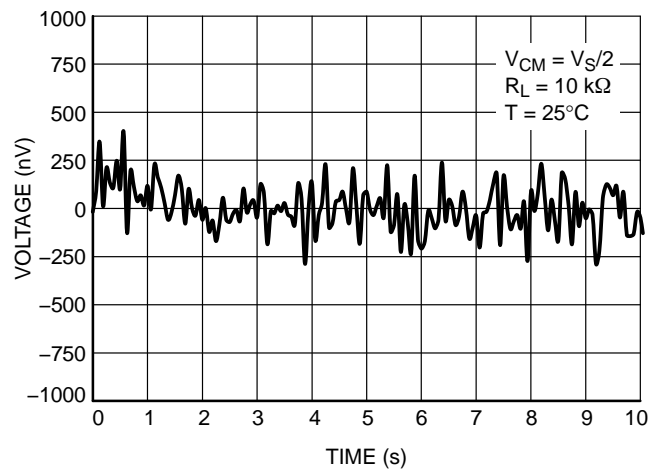

Figure 14. 0.1 Hz to 10 Hz Noise

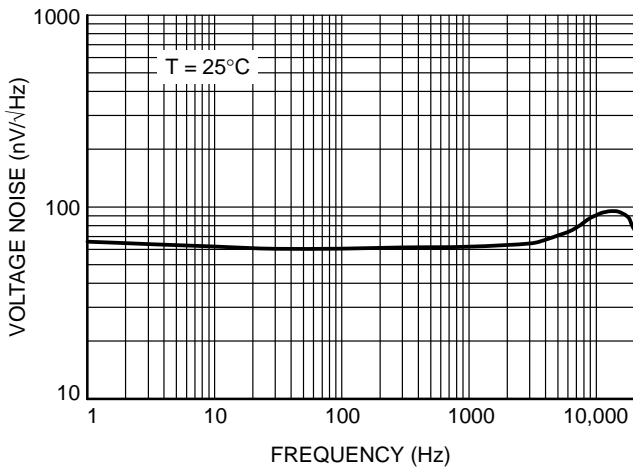

Figure 15. Voltage Noise Density vs. Frequency

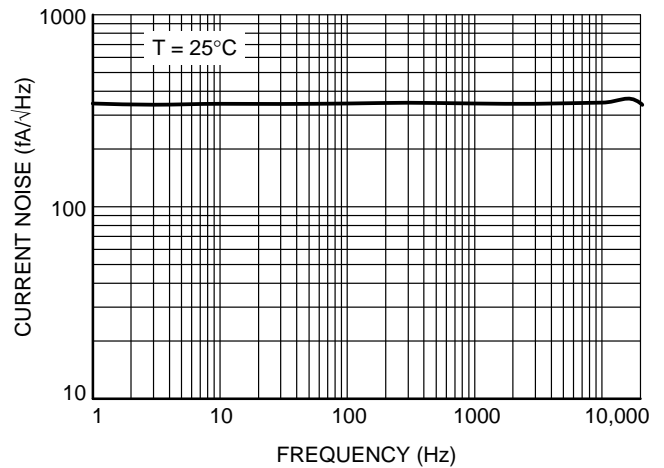

Figure 16. Current Noise Density vs. Frequency

APPLICATIONS INFORMATION

APPLICATION CIRCUITS

Low-Side Current Sensing

The goal of low-side current sensing is to detect over-current conditions or as a method of feedback control. A sense resistor is placed in series with the load to ground. Typically, the value of the sense resistor is less than 100 mΩ

to reduce power loss across the resistor. The op amp amplifies the voltage drop across the sense resistor with a gain set by external resistors R1, R2, R3, and R4 (where R1 = R2, R3 = R4). Precision resistors are required for high accuracy, and the gain is set to utilize the full scale of the ADC for the highest resolution.

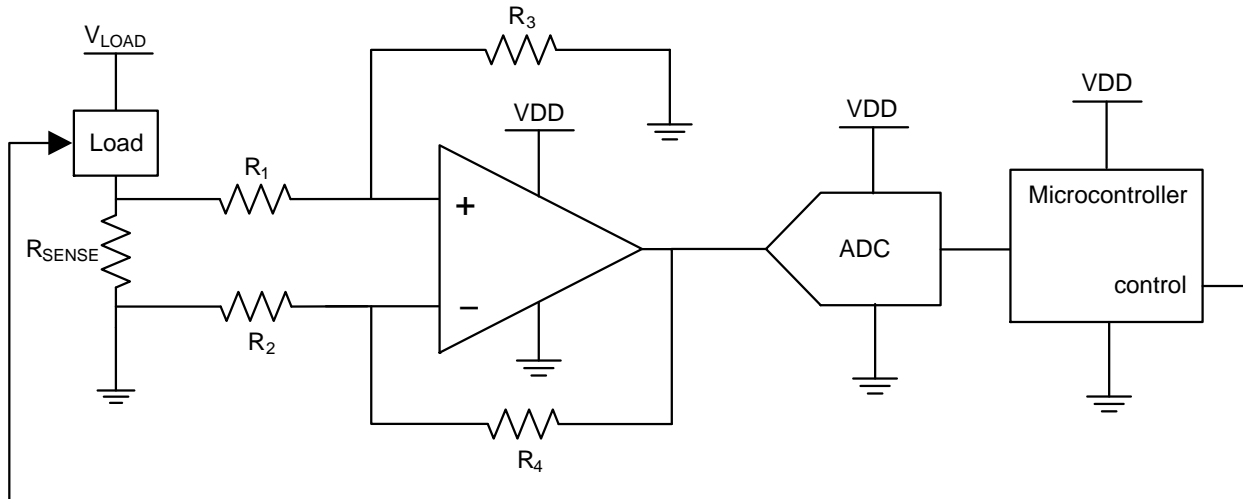

Figure 17. Low-Side Current Sensing

Differential Amplifier for Bridged Circuits

Sensors to measure strain, pressure, and temperature are often configured in a Wheatstone bridge circuit as shown in Figure 18. In the measurement, the voltage change that is

produced is relatively small and needs to be amplified before going into an ADC. Precision amplifiers are recommended in these types of applications due to their high gain, low noise, and low offset voltage.

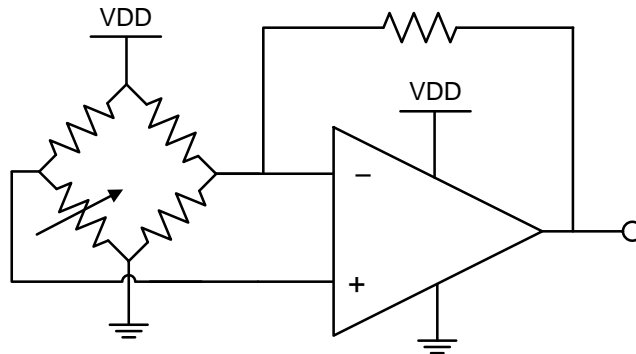

Figure 18. Bridge Circuit Amplification

EMI Susceptibility and Input Filtering

Op amps have varying amounts of EMI susceptibility. Semiconductor junctions can pick up and rectify EMI signals, creating an EMI-induced voltage offset at the output, adding another component to the total error. Input pins are the most sensitive to EMI. The NCS333 op amp family integrates low-pass filters to decrease sensitivity to EMI.

General Layout Guidelines

To ensure optimum device performance, it is important to follow good PCB design practices. Place 0.1 μF decoupling capacitors as close as possible to the supply pins. Keep traces short, utilize a ground plane, choose surface-mount components, and place components as close as possible to the device pins. These techniques will reduce susceptibility to electromagnetic interference (EMI). Thermoelectric effects can create an additional temperature dependent offset voltage at the input pins. To reduce these effects, use metals with low thermoelectric-coefficients and prevent temperature gradients from heat sources or cooling fans.

NCS333, NCS2333, NCS4333

PACKAGE DIMENSIONS

SC-88A (SC-70-5/SOT-353)

CASE 419A-02

ISSUE L

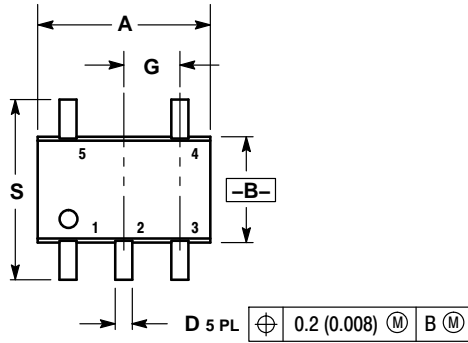

NOTES:

1. DIMENSIONING AND TOLERANCING PER ANSI Y14.5M, 1982.
2. CONTROLLING DIMENSION: INCH.
3. 419A-01 OBSOLETE. NEW STANDARD 419A-02.
4. DIMENSIONS A AND B DO NOT INCLUDE MOLD FLASH, PROTRUSIONS, OR GATE BURRS.

DIM	INCHES		MILLIMETERS	
	MIN	MAX	MIN	MAX
A	0.071	0.087	1.80	2.20
B	0.045	0.053	1.15	1.35
C	0.031	0.043	0.80	1.10
D	0.004	0.012	0.10	0.30
G	0.026 BSC		0.65 BSC	
H	---	0.004	---	0.10
J	0.004	0.010	0.10	0.25
K	0.004	0.012	0.10	0.30
N	0.008 REF		0.20 REF	
S	0.079	0.087	2.00	2.20

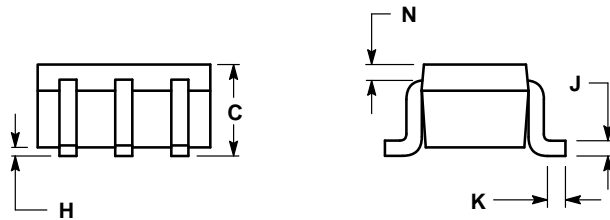

SOLDER FOOTPRINT

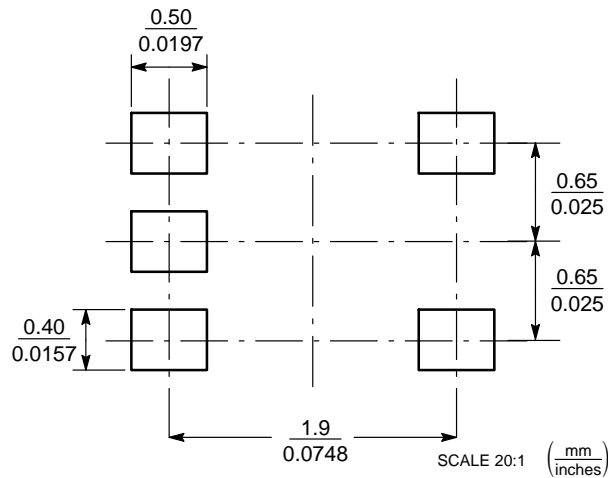

*For additional information on our Pb-Free strategy and soldering details, please download the ON Semiconductor Soldering and Mounting Techniques Reference Manual, SOLDERRM/D.

PACKAGE DIMENSIONS

TSOP-5
CASE 483-02
ISSUE K

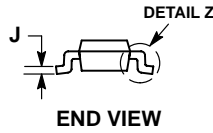
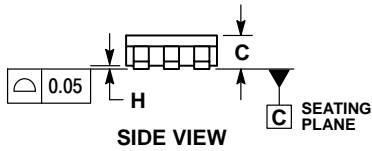
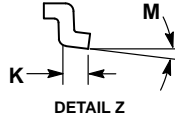
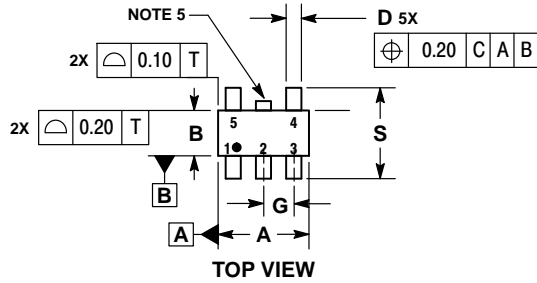

NOTES:

1. DIMENSIONING AND TOLERANCING PER ASME Y14.5M, 1994.
2. CONTROLLING DIMENSION: MILLIMETERS.
3. MAXIMUM LEAD THICKNESS INCLUDES LEAD FINISH THICKNESS. MINIMUM LEAD THICKNESS IS THE MINIMUM THICKNESS OF BASE MATERIAL.
4. DIMENSIONS A AND B DO NOT INCLUDE MOLD FLASH, PROTRUSIONS, OR GATE BURRS. MOLD FLASH, PROTRUSIONS, OR GATE BURRS SHALL NOT EXCEED 0.15 PER SIDE, DIMENSION A.
5. OPTIONAL CONSTRUCTION: AN ADDITIONAL TRIMMED LEAD IS ALLOWED IN THIS LOCATION. TRIMMED LEAD NOT TO EXTEND MORE THAN 0.2 FROM BODY.

DIM	MILLIMETERS	
	MIN	MAX
A	3.00 BSC	
B	1.50 BSC	
C	0.90	1.10
D	0.25	0.50
G	0.95 BSC	
H	0.01	0.10
J	0.10	0.26
K	0.20	0.60
M	0°	10°
S	2.50	3.00

SOLDERING FOOTPRINT*

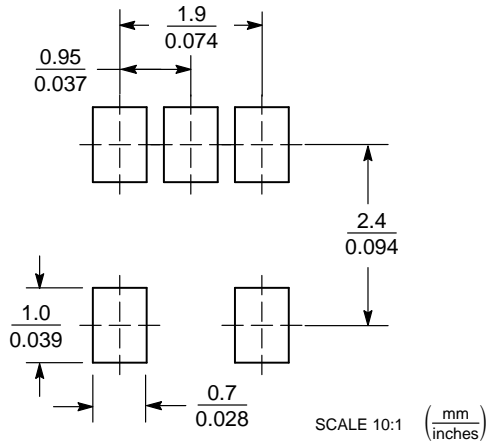

*For additional information on our Pb-Free strategy and soldering details, please download the ON Semiconductor Soldering and Mounting Techniques Reference Manual, SOLDERRM/D.

PACKAGE DIMENSIONS

DFN8, 3x3, 0.65P
CASE 506BW-01
ISSUE O

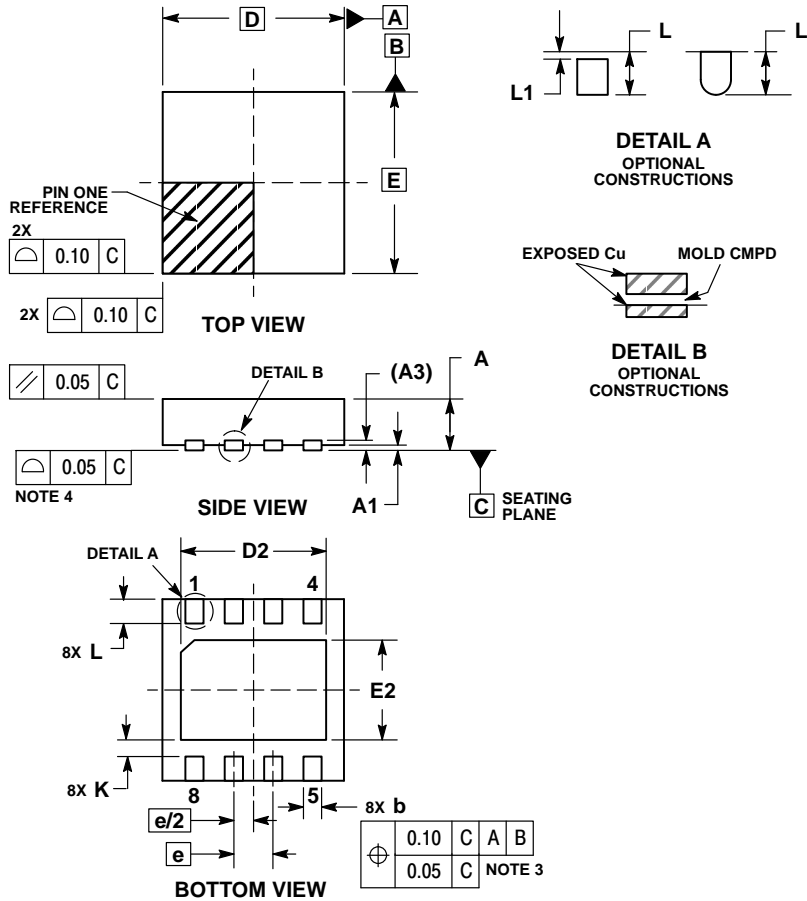

- NOTES:
1. DIMENSIONING AND TOLERANCING PER ASME Y14.5M, 1994.
 2. CONTROLLING DIMENSION: MILLIMETERS.
 3. DIMENSION b APPLIES TO PLATED TERMINAL AND IS MEASURED BETWEEN 0.15 AND 0.30mm FROM THE TERMINAL TIP.
 4. COPLANARITY APPLIES TO THE EXPOSED PAD AS WELL AS THE TERMINALS.

DIM	MILLIMETERS	
	MIN	MAX
A	0.80	1.00
A1	0.00	0.05
A3	0.20	REF
b	0.25	0.35
D	3.00	BSC
D2	2.30	2.50
E	3.00	BSC
E2	1.55	1.75
e	0.65	BSC
K	0.20	---
L	0.35	0.45
L1	0.00	0.15

RECOMMENDED SOLDERING FOOTPRINT*

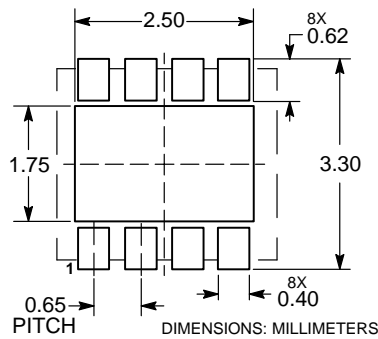

*For additional information on our Pb-Free strategy and soldering details, please download the ON Semiconductor Soldering and Mounting Techniques Reference Manual, SOLDERRM/D.

NCS333, NCS2333, NCS4333

PACKAGE DIMENSIONS

Micro8 / MSOP8 (150 mil)
CASE 846AH
ISSUE A

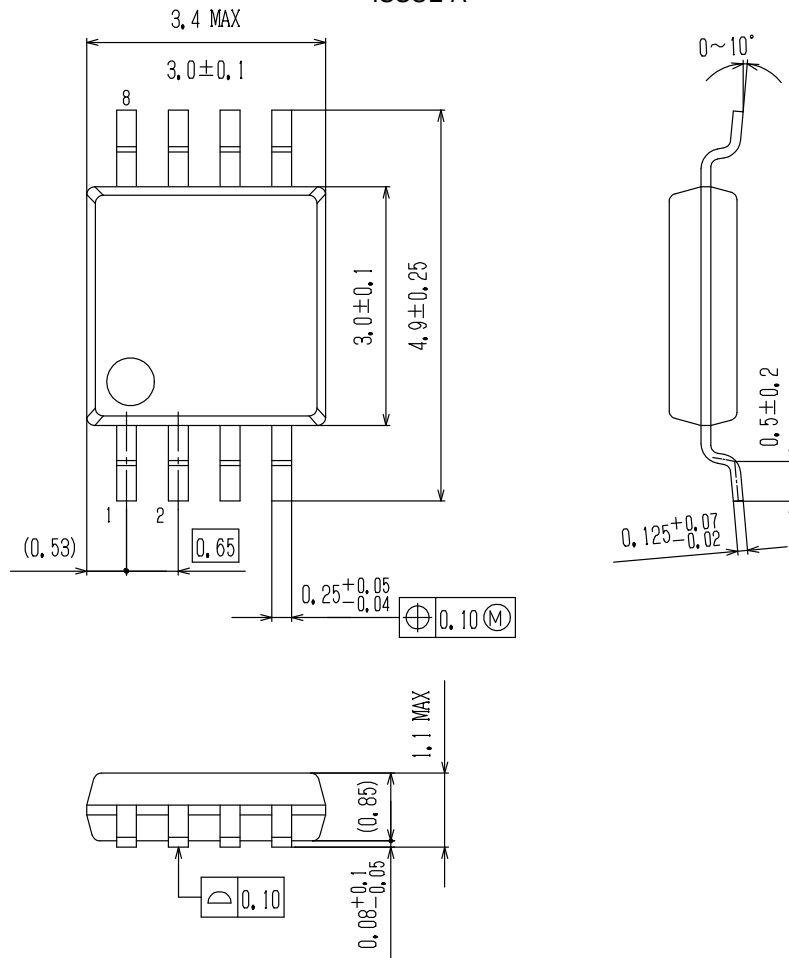

SOLDERING FOOTPRINT*

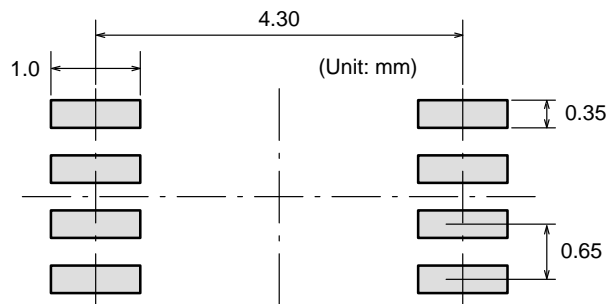

NOTE: The measurements are not to guarantee but for reference only.

*For additional information on our Pb-Free strategy and soldering details, please download the ON Semiconductor Soldering and

NCS333, NCS2333, NCS4333

PACKAGE DIMENSIONS

SOIC-8 NB
CASE 751-07
ISSUE AK

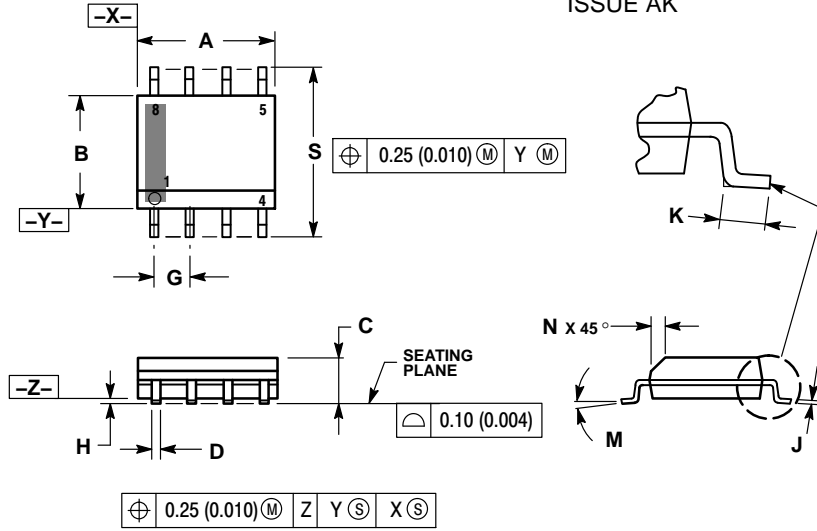

- NOTES:
1. DIMENSIONING AND TOLERANCING PER ANSI Y14.5M, 1982.
 2. CONTROLLING DIMENSION: MILLIMETER.
 3. DIMENSION A AND B DO NOT INCLUDE MOLD PROTRUSION.
 4. MAXIMUM MOLD PROTRUSION 0.15 (0.006) PER SIDE.
 5. DIMENSION D DOES NOT INCLUDE DAMBAR PROTRUSION. ALLOWABLE DAMBAR PROTRUSION SHALL BE 0.127 (0.005) TOTAL IN EXCESS OF THE D DIMENSION AT MAXIMUM MATERIAL CONDITION.
 6. 751-01 THRU 751-06 ARE OBSOLETE. NEW STANDARD IS 751-07.

DIM	MILLIMETERS		INCHES	
	MIN	MAX	MIN	MAX
A	4.80	5.00	0.189	0.197
B	3.80	4.00	0.150	0.157
C	1.35	1.75	0.053	0.069
D	0.33	0.51	0.013	0.020
G	1.27 BSC		0.050 BSC	
H	0.10	0.25	0.004	0.010
J	0.19	0.25	0.007	0.010
K	0.40	1.27	0.016	0.050
M	0°	8°	0°	8°
N	0.25	0.50	0.010	0.020
S	5.80	6.20	0.228	0.244

SOLDERING FOOTPRINT*

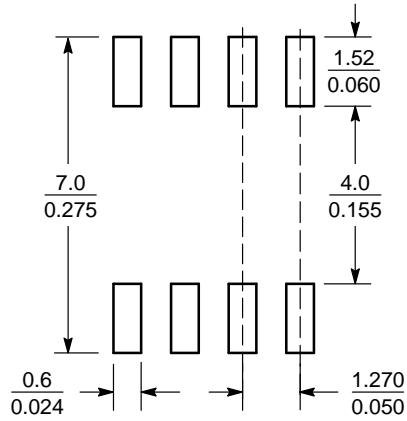

SCALE 6:1 $\left(\frac{\text{mm}}{\text{inches}}\right)$

*For additional information on our Pb-Free strategy and soldering details, please download the ON Semiconductor Soldering and Mounting Techniques Reference Manual, SOLDERRM/D.

NCS333, NCS2333, NCS4333

PACKAGE DIMENSIONS

SOIC-14 NB CASE 751A-03 ISSUE K

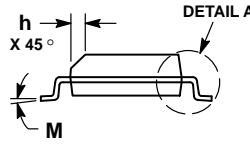
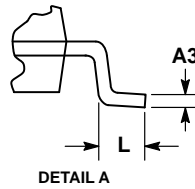
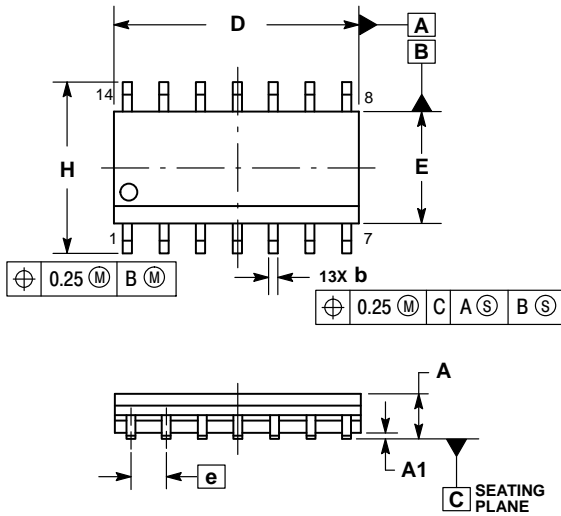

NOTES:

1. DIMENSIONING AND TOLERANCING PER ASME Y14.5M, 1994.
2. CONTROLLING DIMENSION: MILLIMETERS.
3. DIMENSION b DOES NOT INCLUDE DAMBAR PROTRUSION. ALLOWABLE PROTRUSION SHALL BE 0.13 TOTAL IN EXCESS OF AT MAXIMUM MATERIAL CONDITION.
4. DIMENSIONS D AND E DO NOT INCLUDE MOLD PROTRUSIONS.
5. MAXIMUM MOLD PROTRUSION 0.15 PER SIDE.

DIM	MILLIMETERS		INCHES	
	MIN	MAX	MIN	MAX
A	1.35	1.75	0.054	0.068
A1	0.10	0.25	0.004	0.010
A3	0.19	0.25	0.008	0.010
b	0.35	0.49	0.014	0.019
D	8.55	8.75	0.337	0.344
E	3.80	4.00	0.150	0.157
e	1.27 BSC		0.050 BSC	
H	5.80	6.20	0.228	0.244
h	0.25	0.50	0.010	0.019
L	0.40	1.25	0.016	0.049
M	0°	7°	0°	7°

SOLDERING FOOTPRINT*

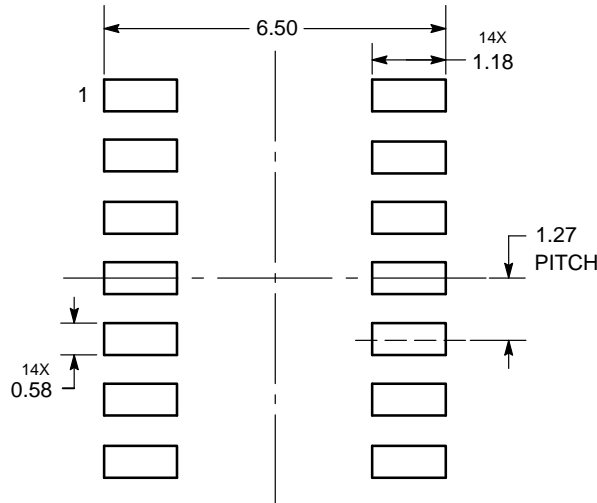

DIMENSIONS: MILLIMETERS

*For additional information on our Pb-Free strategy and soldering details, please download the ON Semiconductor Soldering and Mounting Techniques Reference Manual, SOLDERRM/D.

ON Semiconductor and the are registered trademarks of Semiconductor Components Industries, LLC (SCILLC) or its subsidiaries in the United States and/or other countries. SCILLC owns the rights to a number of patents, trademarks, copyrights, trade secrets, and other intellectual property. A listing of SCILLC's product/patent coverage may be accessed at www.onsemi.com/site/pdf/Patent-Marking.pdf. SCILLC reserves the right to make changes without further notice to any products herein. SCILLC makes no warranty, representation or guarantee regarding the suitability of its products for any particular purpose, nor does SCILLC assume any liability arising out of the application or use of any product or circuit, and specifically disclaims any and all liability, including without limitation special, consequential or incidental damages. "Typical" parameters which may be provided in SCILLC data sheets and/or specifications can and do vary in different applications and actual performance may vary over time. All operating parameters, including "Typicals" must be validated for each customer application by customer's technical experts. SCILLC does not convey any license under its patent rights nor the rights of others. SCILLC products are not designed, intended, or authorized for use as components in systems intended for surgical implant into the body, or other applications intended to support or sustain life, or for any other application in which the failure of the SCILLC product could create a situation where personal injury or death may occur. Should Buyer purchase or use SCILLC products for any such unintended or unauthorized application, Buyer shall indemnify and hold SCILLC and its officers, employees, subsidiaries, affiliates, and distributors harmless against all claims, costs, damages, and expenses, and reasonable attorney fees arising out of, directly or indirectly, any claim of personal injury or death associated with such unintended or unauthorized use, even if such claim alleges that SCILLC was negligent regarding the design or manufacture of the part. SCILLC is an Equal Opportunity/Affirmative Action Employer. This literature is subject to all applicable copyright laws and is not for resale in any manner.

PUBLICATION ORDERING INFORMATION

LITERATURE FULFILLMENT:

Literature Distribution Center for ON Semiconductor
P.O. Box 5163, Denver, Colorado 80217 USA
Phone: 303-675-2175 or 800-344-3860 Toll Free USA/Canada
Fax: 303-675-2176 or 800-344-3867 Toll Free USA/Canada
Email: orderlit@onsemi.com

N. American Technical Support: 800-282-9855 Toll Free
USA/Canada
Europe, Middle East and Africa Technical Support:
Phone: 421 33 790 2910
Japan Customer Focus Center
Phone: 81-3-5817-1050

ON Semiconductor Website: www.onsemi.com

Order Literature: <http://www.onsemi.com/orderlit>

For additional information, please contact your local Sales Representative