

Proximity and ambient light sensing (ALS) module

Datasheet - production data

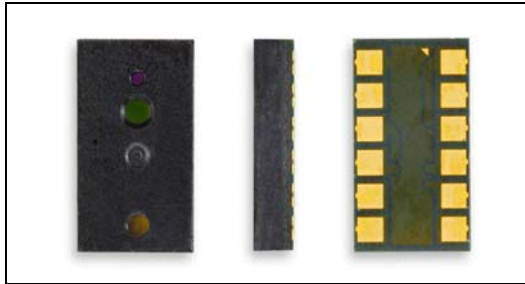

Features

- Three-in-one smart optical module
 - Proximity sensor
 - Ambient Light Sensor
 - VCSEL light source
- Fast, accurate distance ranging
 - Measures absolute range from 0 to above 10 cm
 - Independent of object reflectance
 - Ambient rejection
 - Crosstalk compensation for cover glass
 - Ranging beyond 100mm is possible with certain target reflectances and ambient conditions but not guaranteed
- Gesture recognition
 - Distance and signal level can be used by host system to implement gesture recognition
 - Demo systems available.
- Ambient light sensor
 - High dynamic range
 - Accurate/sensitive in ultra-low light
 - Calibrated output value in lux
- Easy integration
 - Single reflowable component
 - No additional optics or gasket
 - Single power supply
 - I²C interface for device control and data

- Two programmable GPIO
 - Window and thresholding functions for both ranging and ALS

Description

The VL6180X is the latest product based on ST's patented **FlightSense™** technology. This is a ground-breaking technology allowing absolute distance to be measured independent of target reflectance. Instead of estimating the distance by measuring the amount of light reflected back from the object (which is significantly influenced by color and surface), the VL6180X precisely measures the time the light takes to travel to the nearest object and reflect back to the sensor (Time-of-Flight).

Combining an IR emitter, a range sensor and an ambient light sensor in a three-in-one ready-to-use reflowable package, the VL6180X is easy to integrate and saves the end-product maker long and costly optical and mechanical design optimizations.

The module is designed for ultra low power operation. Ranging and ALS measurements can be automatically performed at user defined intervals. Multiple threshold and interrupt schemes are supported to minimize host operations.

Host control and result reading is performed using an I²C interface. Optional additional functions, such as measurement ready and threshold interrupts, are provided by two programmable GPIO pins.

Applications

- Smartphones/portable touchscreen devices
- Tablet/laptop/gaming devices
- Domestic appliances/industrial devices

Contents

- 1 Overview 8**
 - 1.1 Technical specification 8
 - 1.2 System block diagram 9
 - 1.3 Device pinout 9
 - 1.4 Application schematic 10
 - 1.5 Recommended solder pad dimensions11
 - 1.6 Recommended reflow profile11

- 2 Functional description 12**
 - 2.1 System state diagram 13
 - 2.2 Timing diagram 14
 - 2.3 Software overview 15
 - 2.4 Operating modes 16
 - 2.4.1 Single-shot range/ALS operation 17
 - 2.4.2 Continuous range/ALS operation 17
 - 2.4.3 Interleaved mode 18
 - 2.4.4 Continuous mode limits 18
 - 2.5 Range timing 19
 - 2.6 Interrupt modes 20
 - 2.7 Range error codes 20
 - 2.8 Range checks 21
 - 2.8.1 Early convergence estimate (ECE) 21
 - 2.8.2 Range ignore 22
 - 2.8.3 Signal-to-noise ratio (SNR) 23
 - 2.9 Manual/autoVHV calibration 23
 - 2.10 History buffer 23
 - 2.11 Current consumption 24
 - 2.11.1 Ranging current consumption 24
 - 2.11.2 Current consumption calculator 25
 - 2.11.3 Current distribution 26
 - 2.12 Other system considerations 27
 - 2.12.1 Part-to-part range offset 27

2.12.2	Cross-talk	27
2.12.3	Offset calibration procedure	27
2.12.4	Cross-talk calibration procedure	28
2.12.5	Cross-talk limit	29
2.12.6	Cross-talk vs air gap	29
2.13	Ambient light sensor (ALS)	30
2.13.1	Field of view	30
2.13.2	Spectral response	30
2.13.3	ALS dynamic range	31
2.13.4	ALS count to lux conversion	31
2.13.5	Integration period	32
2.13.6	ALS gain selection	32
3	Electrical characteristics	33
3.1	Absolute maximum ratings	33
3.2	Normal operating conditions	33
3.3	Current consumption	33
3.4	Electrical characteristics	34
4	Performance specification	35
4.1	Proximity ranging (0 to 100mm)	35
4.1.1	Max range vs. ambient light level	35
4.2	ALS performance	36
5	I²C control interface	37
6	Device registers	40
6.1	Register encoding formats	40
6.2	Register descriptions	43
6.2.1	IDENTIFICATION__MODEL_ID	43
6.2.2	IDENTIFICATION__MODEL_REV_MAJOR	43
6.2.3	IDENTIFICATION__MODEL_REV_MINOR	43
6.2.4	IDENTIFICATION__MODULE_REV_MAJOR	44
6.2.5	IDENTIFICATION__MODULE_REV_MINOR	44
6.2.6	IDENTIFICATION__DATE_HI	44
6.2.7	IDENTIFICATION__DATE_LO	45

6.2.8 IDENTIFICATION__TIME 45

6.2.9 SYSTEM__MODE_GPIO0 46

6.2.10 SYSTEM__MODE_GPIO1 47

6.2.11 SYSTEM__HISTORY_CTRL 48

6.2.12 SYSTEM__INTERRUPT_CONFIG_GPIO 49

6.2.13 SYSTEM__INTERRUPT_CLEAR 49

6.2.14 SYSTEM__FRESH_OUT_OF_RESET 50

6.2.15 SYSTEM__GROUPED_PARAMETER_HOLD 50

6.2.16 SYSRANGE__START 51

6.2.17 SYSRANGE__THRESH_HIGH 51

6.2.18 SYSRANGE__THRESH_LOW 52

6.2.19 SYSRANGE__INTERMEASUREMENT_PERIOD 52

6.2.20 SYSRANGE__MAX_CONVERGENCE_TIME 52

6.2.21 SYSRANGE__CROSSTALK_COMPENSATION_RATE 53

6.2.22 SYSRANGE__CROSSTALK_VALID_HEIGHT 53

6.2.23 SYSRANGE__EARLY_CONVERGENCE_ESTIMATE 53

6.2.24 SYSRANGE__PART_TO_PART_RANGE_OFFSET 54

6.2.25 SYSRANGE__RANGE_IGNORE_VALID_HEIGHT 54

6.2.26 SYSRANGE__RANGE_IGNORE_THRESHOLD 54

6.2.27 SYSRANGE__MAX_AMBIENT_LEVEL_MULT 55

6.2.28 SYSRANGE__RANGE_CHECK_ENABLES 55

6.2.29 SYSRANGE__VHV_RECALIBRATE 56

6.2.30 SYSRANGE__VHV_REPEAT_RATE 56

6.2.31 SYSALS__START 57

6.2.32 SYSALS__THRESH_HIGH 57

6.2.33 SYSALS__THRESH_LOW 58

6.2.34 SYSALS__INTERMEASUREMENT_PERIOD 58

6.2.35 SYSALS__ANALOGUE_GAIN 59

6.2.36 SYSALS__INTEGRATION_PERIOD 59

6.2.37 RESULT__RANGE_STATUS 60

6.2.38 RESULT__ALS_STATUS 61

6.2.39 RESULT__INTERRUPT_STATUS_GPIO 62

6.2.40 RESULT__ALS_VAL 62

6.2.41 RESULT__HISTORY_BUFFER_x 63

6.2.42 RESULT__RANGE_VAL 64

6.2.43 RESULT__RANGE_RAW 64

6.2.44 RESULT__RANGE_RETURN_RATE 64

6.2.45	RESULT__RANGE_REFERENCE_RATE	65
6.2.46	RESULT__RANGE_RETURN_SIGNAL_COUNT	65
6.2.47	RESULT__RANGE_REFERENCE_SIGNAL_COUNT	66
6.2.48	RESULT__RANGE_RETURN_AMB_COUNT	66
6.2.49	RESULT__RANGE_REFERENCE_AMB_COUNT	66
6.2.50	RESULT__RANGE_RETURN_CONV_TIME	67
6.2.51	RESULT__RANGE_REFERENCE_CONV_TIME	67
6.2.52	READOUT__AVERAGING_SAMPLE_PERIOD	67
6.2.53	FIRMWARE__BOOTUP	68
6.2.54	FIRMWARE__RESULT_SCALER	68
6.2.55	I2C_SLAVE__DEVICE_ADDRESS	68
6.2.56	INTERLEAVED_MODE__ENABLE	69
7	Outline drawing	70
8	Laser safety considerations	72
8.1	Compliance	72
9	Ordering information	73
9.1	Traceability and identification	73
9.2	Part marking	73
9.3	Packaging	74
9.3.1	Package labeling	74
9.4	Storage	75
9.5	ROHS compliance	75
10	ECOPACK®	76
11	Revision history	77

List of tables

Table 1.	Technical specification	8
Table 2.	VL6180X pin numbers and signal descriptions.	10
Table 3.	Recommended reflow profile	11
Table 4.	Power-up timing constraints	14
Table 5.	Operating modes	16
Table 6.	Interleaved mode limits (10 Hz operation)	19
Table 7.	Typical range convergence time (ms).	20
Table 8.	Range error codes	21
Table 9.	History buffer	24
Table 10.	Typical current consumption in different operating states	24
Table 11.	Breakdown of current consumption	25
Table 12.	Current consumption on AVDD and AVDD_VCSEL.	26
Table 13.	ALS dynamic range	31
Table 14.	Actual gain values.	32
Table 15.	Absolute maximum ratings	33
Table 16.	Normal operating conditions	33
Table 17.	Current consumption	33
Table 18.	Digital I/O electrical characteristics	34
Table 19.	Ranging specification	35
Table 20.	Worst case max range vs. ambient 0 to 100mm	35
Table 21.	ALS performance	36
Table 22.	Register groups	40
Table 23.	32-bit register example	40
Table 24.	9.7 and 4.4 register formats	40
Table 25.	Register summary.	41
Table 26.	Delivery format	73
Table 27.	Storage conditions	75
Table 28.	Document revision history	77

List of figures

Figure 1.	VL6180X block diagram	9
Figure 2.	VL6180X pinout	9
Figure 3.	Root part number 1 schematic	10
Figure 4.	Recommended solder pattern	11
Figure 5.	Recommended reflow profile	11
Figure 6.	Typical ranging performance	12
Figure 7.	ALS linearity	12
Figure 8.	System state diagram	13
Figure 9.	Power-up timing	14
Figure 10.	Software overview	15
Figure 11.	Interleaved mode	18
Figure 12.	Total range execution time	19
Figure 13.	Early convergence estimate (ECE)	22
Figure 14.	Typical ranging current consumption (10 Hz sampling rate)	25
Figure 15.	VCSEL pulse duty cycle	26
Figure 16.	Part-to-part range offset	27
Figure 17.	Cross-talk compensation	27
Figure 18.	Cross-talk vs air gap	29
Figure 19.	ALS angular response	30
Figure 20.	ALS spectral response	30
Figure 21.	Serial interface data transfer protocol	37
Figure 22.	I2C device address	37
Figure 23.	Single location, single write)	37
Figure 24.	Single location, single read	38
Figure 25.	Multiple location write	38
Figure 26.	Multiple location read	39
Figure 27.	Outline drawing (page 1/2)	70
Figure 28.	Outline drawing (page 2/2)	71
Figure 29.	Class 1 laser product label	72
Figure 30.	Part marking	73
Figure 31.	Tape and reel packaging	74
Figure 32.	Package labeling	74

1 Overview

This datasheet is applicable to the final VL6180X ROM code revision.

1.1 Technical specification

Table 1. Technical specification

Feature	Detail
Package	Optical LGA12
Size	4.8 x 2.8 x 1.0 mm
Ranging	0 to 100 mm ⁽¹⁾
Ambient light sensor	< 1 Lux up to 100 kLux ⁽²⁾ 16-bit output ⁽³⁾ 8 manual gain settings
Operating voltage:	
• Functional range	2.6 to 3.0 V
• Optimum range ⁽⁴⁾	2.7 to 2.9 V
Operating temperature:	
• Functional range	-20 to 70°C
• Optimum range ⁽⁴⁾	-10 to 60°C
Typical power consumption	Hardware standby (GPIO0 = 0): < 1 µA Software standby: < 1 µA ALS: 300 µA Ranging: 1.7 mA (typical average) ⁽⁵⁾
IR emitter	850 nm
I ² C	400 kHz serial bus Address: 0x29 (7-bit)

1. Ranging beyond 100 mm is possible with certain target reflectances and ambient conditions but not guaranteed
2. When used under a cover glass with 10% transmission in the visible spectrum
3. Digital output easily converted to Lux
4. Please refer to [Table 19.: Ranging specification](#)
5. Assumes 10 Hz sampling rate, 17% reflective target at 50 mm

1.2 System block diagram

Figure 1. VL6180X block diagram

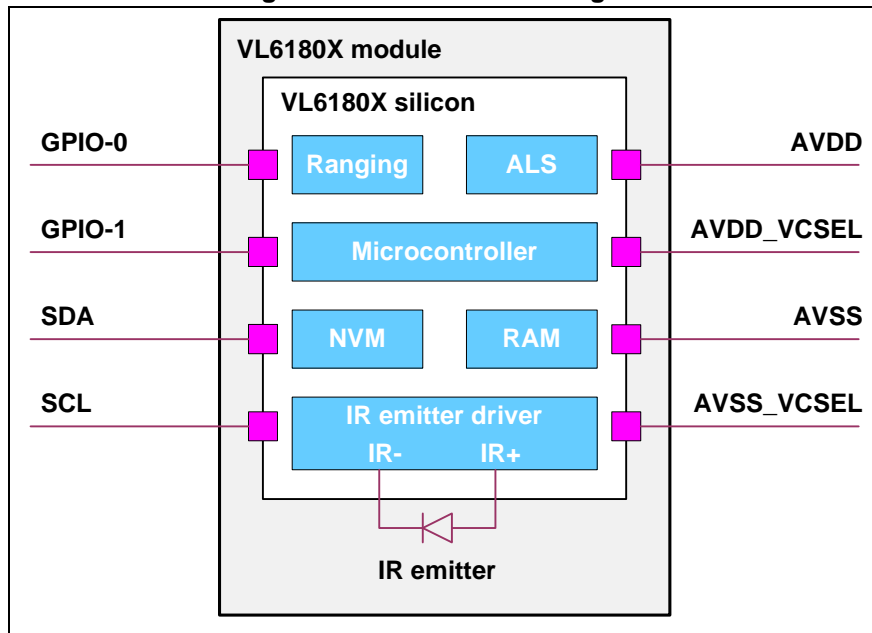

1.3 Device pinout

Figure 2 shows the pinout of the VL6180X.

Figure 2. VL6180X pinout

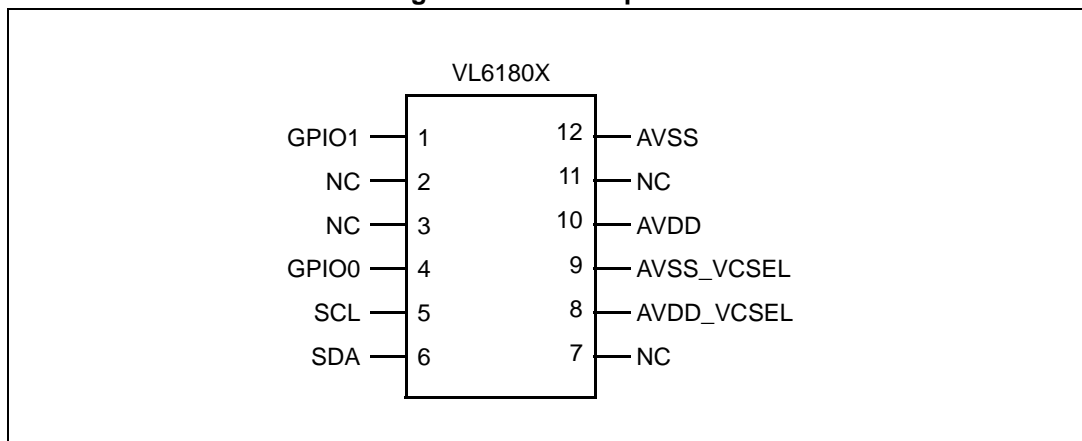

Table 2. VL6180X pin numbers and signal descriptions

Pin number	Signal name	Signal type	Signal description
1	GPIO1	Digital I/O	Interrupt output. Open-drain.
2	NC		No connect or ground
3	NC		No connect or ground
4	GPIO0/CE	Digital I/O	Power-up default is chip enable (CE). It should be pulled high with a 47 kΩ resistor.
5	SCL	Digital input	I ² C serial clock
6	SDA	Digital I/O	I ² C serial data
7	NC		No connect or ground
8	AVDD_VCSEL	Supply	VCSEL power supply. 2.6 to 3.0 V
9	AVSS_VCSEL	Ground	VCSEL ground
10	AVDD	Supply	Digital/analog power supply. 2.6 to 3.0 V
11	NC		No connect or ground
12	AVSS	Ground	Digital/analog ground

1.4 Application schematic

Figure 3 shows the schematic of the VL6180X.

Figure 3. Root part number 1 schematic

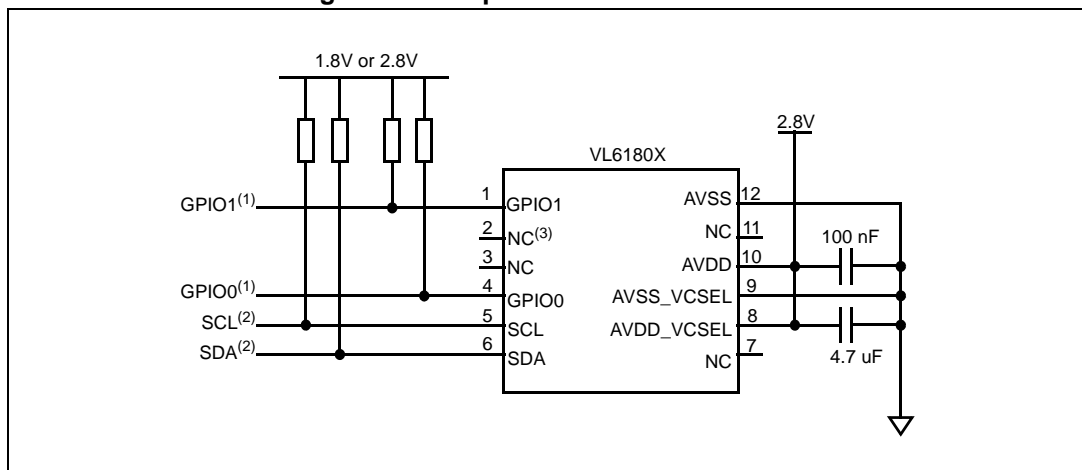

1. Open drain. Recommend 47 kΩ
2. Open drain. Pull up resistors typically fitted once per I²C bus at host
3. No connects can also be grounded if required

Note: Capacitors on AVDD and AVDD_VCSEL should be placed as close as possible to the supply pads.

1.5 Recommended solder pad dimensions

Figure 4. Recommended solder pattern

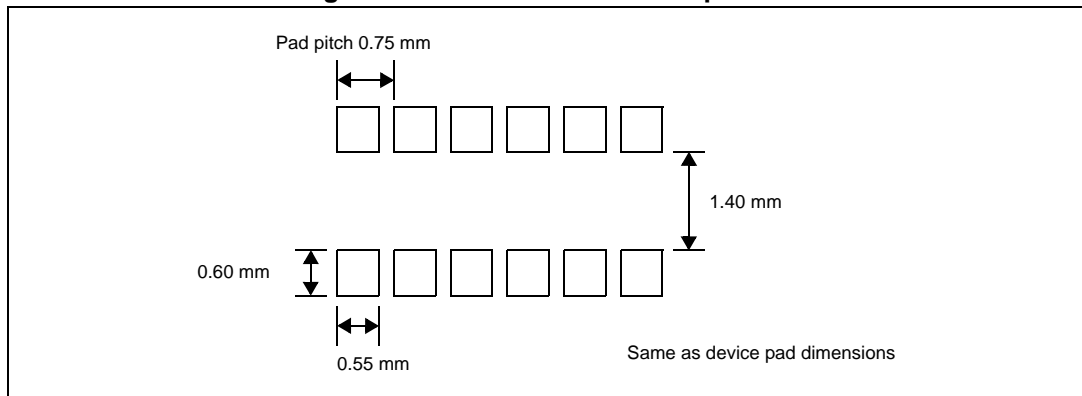

1.6 Recommended reflow profile

The recommend reflow profile is shown in [Figure 5](#) and [Table 3](#).

Figure 5. Recommended reflow profile

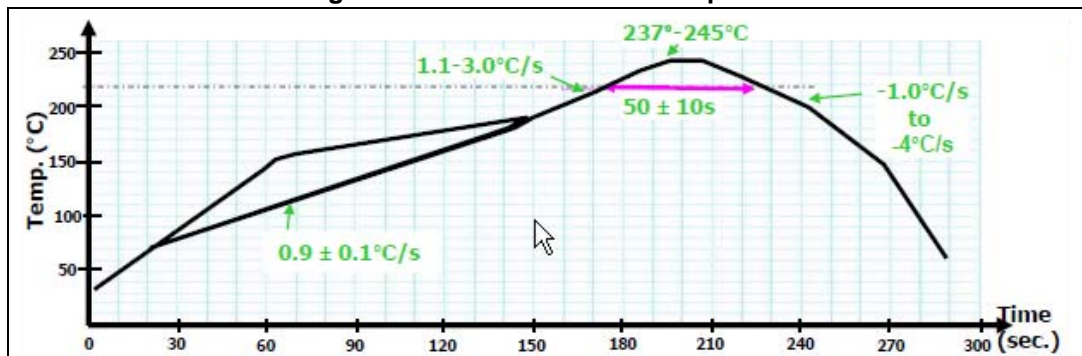

Table 3. Recommended reflow profile

Profile	Ramp to strike	
Temperature gradient in preheat	(T= 70 - 180°C):	0.9 +/- 0.1°C/s
Temperature gradient	(T= 200 - 225°C):	1.1 - 3.0°C/s
Peak temperature in reflow	237°C - 245°C	
Time above 220°C	50 +/- 10 seconds	
Temperature gradient in cooling	-1 to -4 °C/s (-6°C/s maximum)	
Time from 50 to 220°C	160 to 220 seconds	

Note: As the VL6180X package is not sealed, only a dry re-flow process should be used (such as convection re-flow). Vapor phase re-flow is not suitable for this type of optical component.

The VL6180X is an optical component and as such, it should be treated carefully. This would typically include using a 'no-wash' assembly process.

2 Functional description

This section gives an overview of the key features of the VL6180X and describes the different modes of operation of the ALS and proximity sensors.

Typical ranging performance of the VL6180X is shown in [Figure 6](#). This demonstrates the reflectance independence and range accuracy of the VL6180X from 0 to 100 mm for 3%, 5%, 17% and 88% reflective targets. The example shown here is with ST cover glass and a 1.0 mm air gap.

[Figure 7](#) shows typical ALS linearity vs gain over a wide dynamic range. More details about the ambient light sensor can be found in [Section 2.13](#).

Figure 6. Typical ranging performance

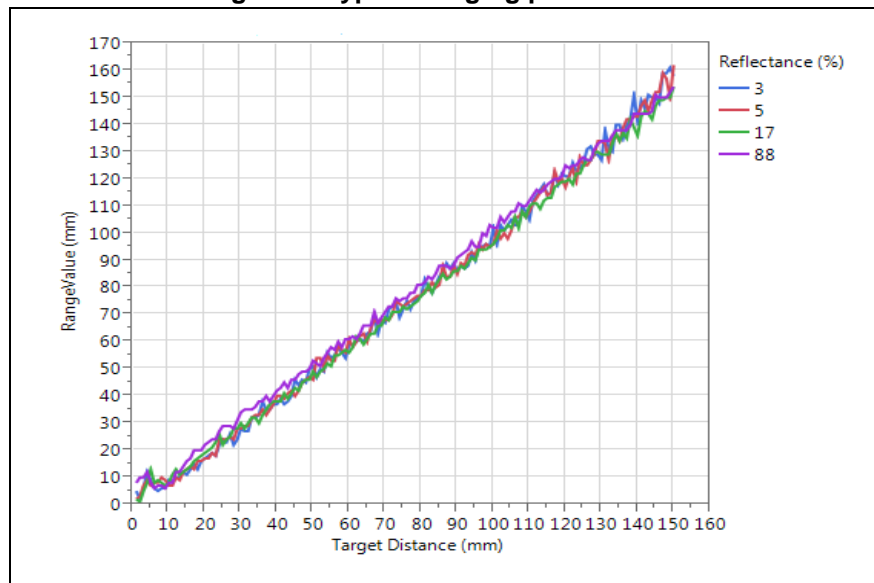
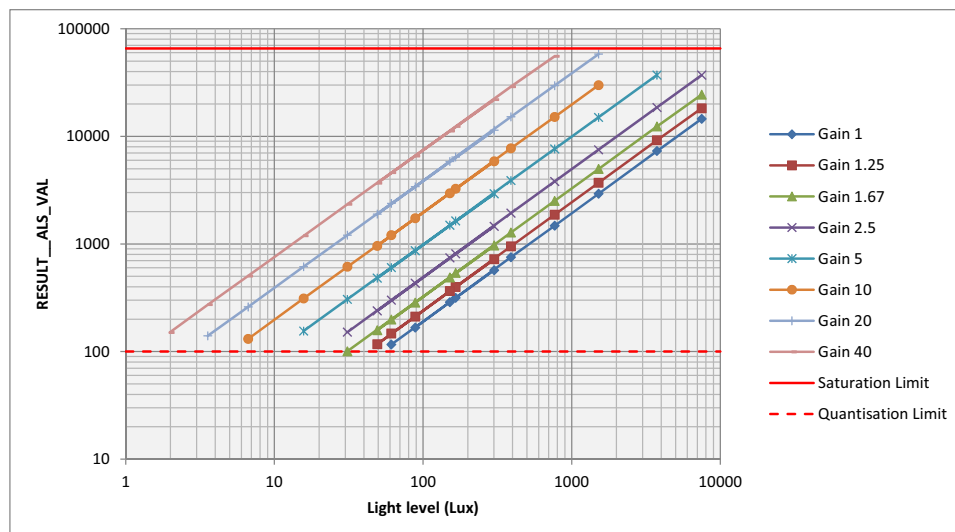

Figure 7. ALS linearity



2.1 System state diagram

Figure 8 describes the main operating states of the VL6180X. Hardware standby is the reset state (GPIO0=0)^(a). The device is held in reset until GPIO0 is de-asserted. Note that the device will not respond to I²C communication in this mode. When GPIO0=1, the device enters software standby after the internal MCU boot sequence has completed. Once in software standby, ST recommended register initialization settings^(b) can be applied along with any required application specific register settings. Thereafter, the host can command single-shot range or ALS measurements or alternatively program one of the continuous operating modes where the device uses an internal timer to schedule measurements at specified intervals. See Section 2.4.3: *Interleaved mode*.

Figure 8. System state diagram

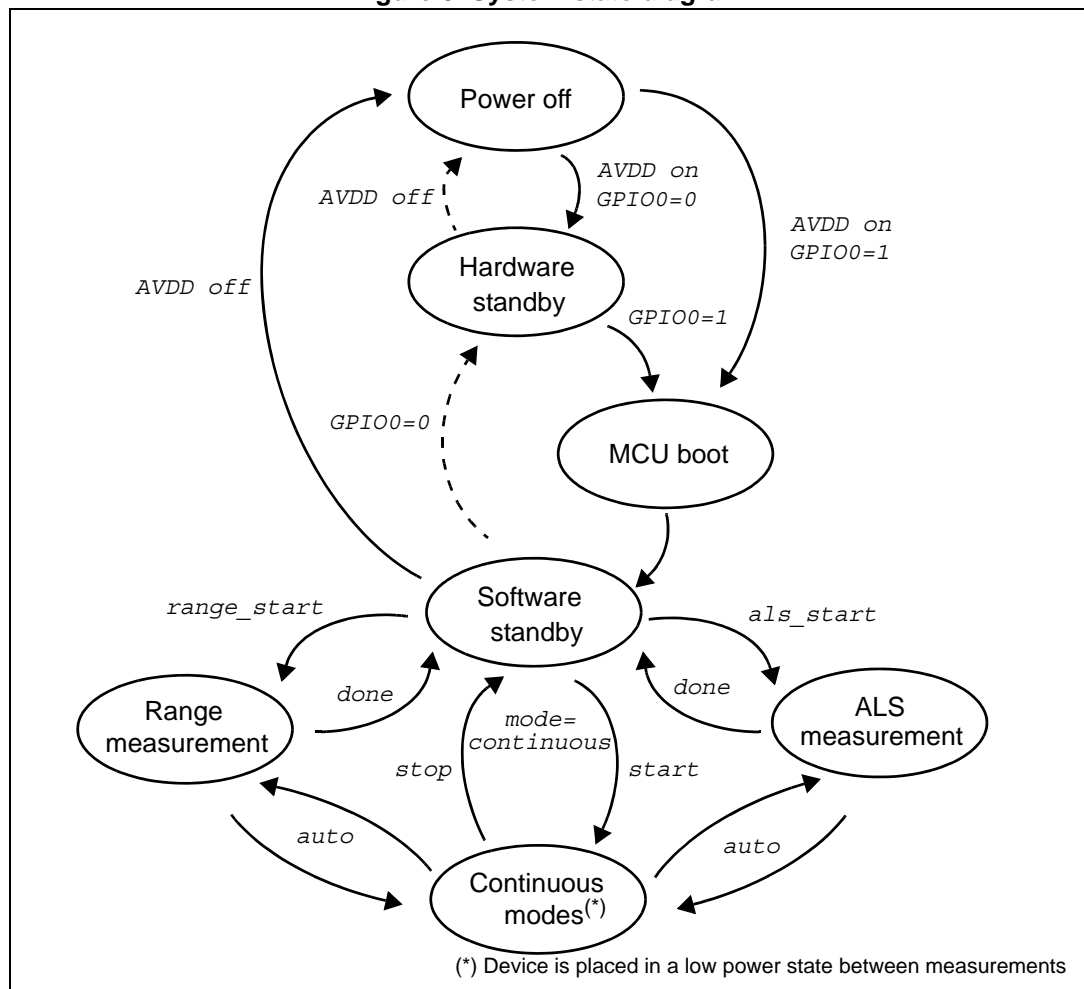

a. Use of GPIO0 is optional

b. Please contact STMicroelectronics for the latest settings

2.2 Timing diagram

Figure 9 and Table 4 show the Root part number 1 power-up timing constraints.

- AVDD_VCSEL must be applied before or at the same time as AVDD.
- GPIO0 defaults to an active low shutdown input. When GPIO0 = 0, the device is in hardware standby. If GPIO0 is not used it should be connected to AVDD.
- The internal microprocessor (MCU) boot sequence commences when AVDD is up and GPIO0 is high whichever is the later.
- GPIO1 power-up default is output low. It is tri-stated during the MCU boot sequence.

Note: In hardware standby, GPIO1 is output low and will sink current through any pull-up resistor. This leakage can be minimized by increasing the value of the pull-up resistor.

- After the MCU boot sequence the device enters software standby. The software standby state can be determined by polling SYSTEM_FRESH_OUT_OF_RESET{0x16}. Host initialization can commence immediately after entering software standby.

Figure 9. Power-up timing

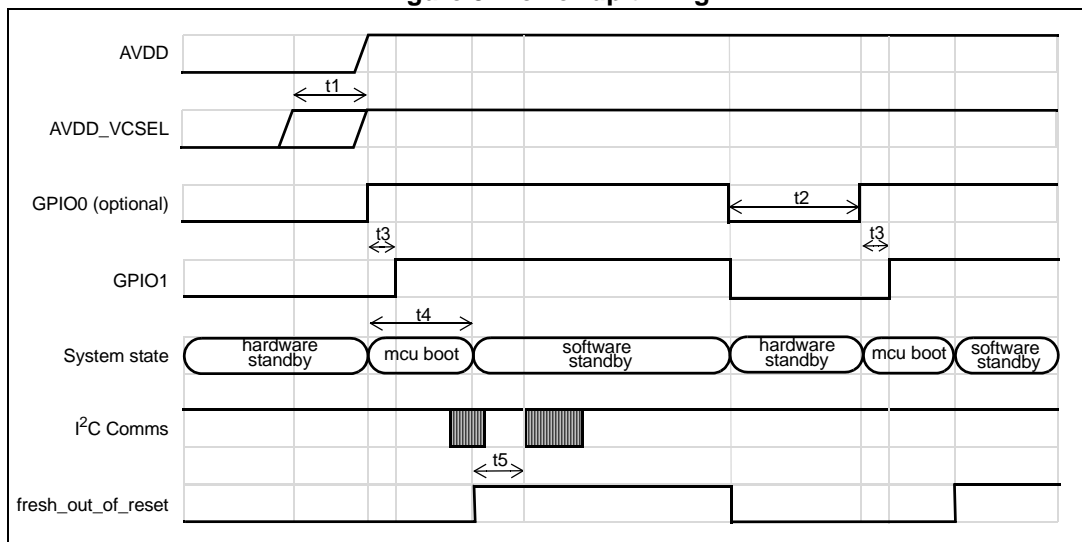

Table 4. Power-up timing constraints

Symbol	Parameter	Min	Max	Unit
t1	AVDD_VCSEL power applied after AVDD	-	0	ms
t2	Minimum reset on GPIO0	100	-	ns
t3	GPIO1 output low after hardware standby	-	400	µs
t4	MCU boot	-	1	ms
t5	Software standby to host initialization	-	0	ms

2.3 Software overview

Figure 10 shows a simple start-up routine from initialization to completing a range or ALS measurement.

Figure 10. Software overview

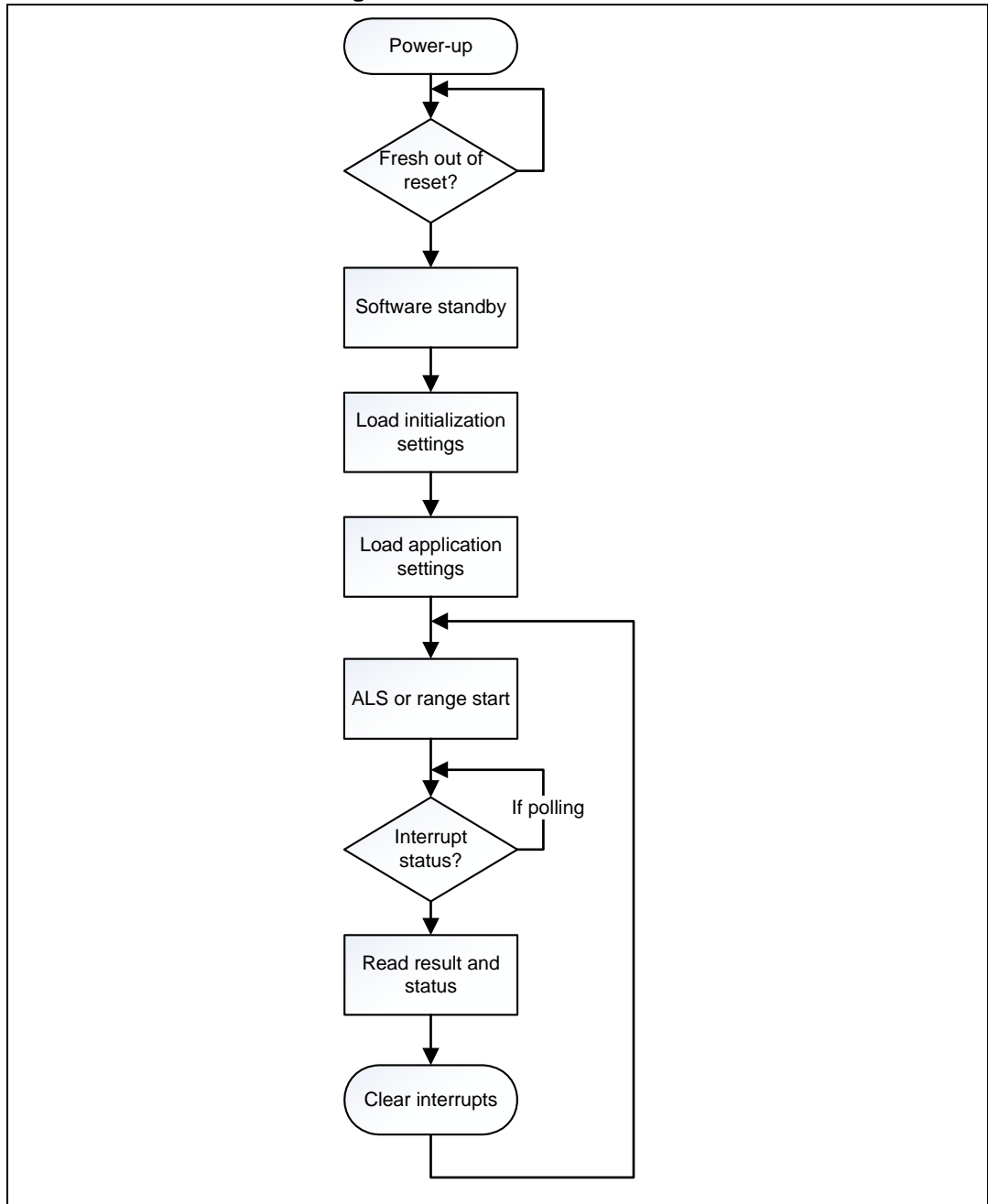

2.4 Operating modes

Table 5. describes the operating modes of this device.

- Modes 1 and 2 are single-shot range and ALS measurements.
- Modes 3 and 4 are stand-alone, continuous operation for either range or ALS.
- Modes 5 and 6 are for mixed continuous and single-shot mode operations where regular measurements are required from one of the sensors and only occasional measurements are required from the other.

Note: In modes 5 and 6, single-shot operation takes the priority i.e. if a scheduled measurement is in progress when the host requests a single-shot measurement, the scheduled measurement will be aborted and will resume on the next available time slot.

- Mode 7 allows both ALS and range measurements to be scheduled at regular intervals. The ALS measurement is completed first immediately followed by a range measurement. Interleaved mode is described in more detail in [Section 2.4.3](#).

Table 5. Operating modes

Mode	Function	Range		ALS		Priority
		Single	Continuous	Single	Continuous	
1	Range single-shot	•				Range
2	ALS single-shot			•		ALS
3	Range continuous		•			Range
4	ALS continuous				•	ALS
5	Range continuous and ALS single-shot		•	•		ALS
6	Range single-shot and ALS continuous	•			•	Range
7	Interleaved mode: Range Continuous and ALS Continuous		•		•	-

2.4.1 Single-shot range/ALS operation

A single-shot range or ALS measurement is performed as follows:

- Write 0x01 to the `SYSRANGE__START` register{0x18}.
- When the measurement is completed, bit 2 of `RESULT__INTERRUPT_STATUS_GPIO`{0x4F} will be set.
- Similarly, a single-shot ALS measurement is initiated by writing 0x01 to the `SYSALS__START` register{0x38}.
- When the measurement is completed, bit 5 of `RESULT__INTERRUPT_STATUS_GPIO`{0x4F} will be set. Note that in both cases the start bit, (bit 0) auto-clears.
- The range result is read from `RESULT__RANGE_VAL`{0x62}.
- The ALS result is read from `RESULT__ALS_VAL`{0x50}.
- Interrupt status flags are cleared by writing a '1' to the appropriate bit of `SYSTEM__INTERRUPT_CLEAR`{0x15}.
- Bit 0 of `RESULT__RANGE_STATUS`{0x4D} and `RESULT__ALS_STATUS`{0x4E} indicate when either sensor is ready for the next operation.
- Error codes are indicated in bits [7:4] of the status registers

A detailed description of all the user accessible registers is given in [Section 6: Device registers](#).

Note: Single-shot ALS and range operations cannot be performed simultaneously. Only one of these operations should be performed at any one time and once started must be allowed to complete before another measurement is started. This is because any current operation will be aborted if another is started.

2.4.2 Continuous range/ALS operation

A continuous range or ALS measurement is performed as follows:

- Write 0x03 to the `SYSRANGE__START` or `SYSALS__START` registers. In both cases, bit 1 of the register sets the mode to continuous
- When a measurement is completed either bit 2 or bit 5 of `RESULT__INTERRUPT_STATUS_GPIO`{0x4F} will be set.
- Results are read from `RESULT__RANGE_VAL`{0x62} or `RESULT__ALS_VAL`{0x50}.
- Interrupt status flags are cleared by writing a '1' to the appropriate bit of `SYSTEM__INTERRUPT_CLEAR`{0x15}.
- Thereafter, measurements will be scheduled according to the relevant inter-measurement period (see `SYSRANGE__INTERMEASUREMENT_PERIOD`{0x1B} or `SYSALS__INTERMEASUREMENT_PERIOD`{0x3E}).
- Continuous mode operation can be stopped by writing 0 to either `START` register. Continuous operation will be halted immediately and any pending measurement will be aborted.

Note: It is not recommended to run range and ALS continuous modes simultaneously (i.e. asynchronously). Instead, mode 7 'interleaved mode' in [Table 5](#). should be used. In 'interleaved mode', scheduled range and ALS measurements operate off a single timer with a range measurement proceeding immediately after every ALS measurement.

2.4.3 Interleaved mode

Figure 11. describes the continuous interleaved mode of operation where an ALS measurement is immediately followed by a range measurement and repeated after an interval specified by the ALS inter-measurement period.

To enable interleaved mode, set `INTERLEAVED_MODE_ENABLE{0x2A3} = 1`. Use `SYSALS__START` and `SYSALS__INTERMEASUREMENT_PERIOD` to control interleaved operation.

Note: Continuous range settings have no effect in this mode.

Figure 11. Interleaved mode

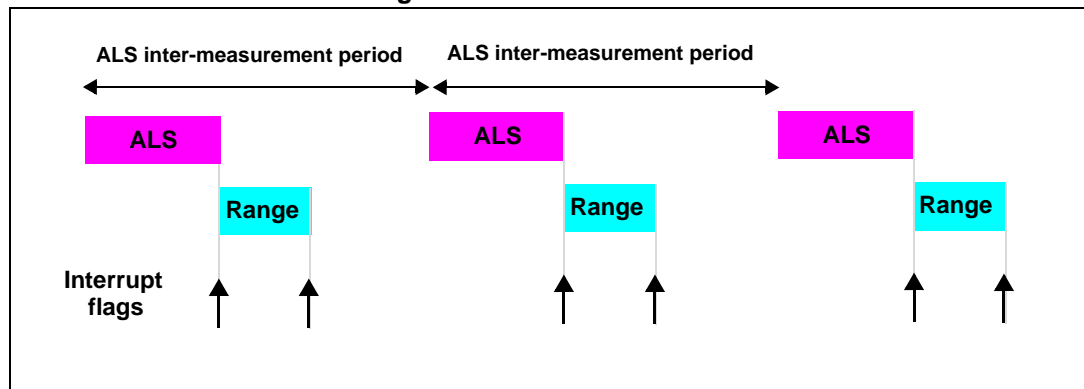

Note: To ensure correct operation in any of the continuous modes, the user must ensure that the inter-measurement period is sufficient for the operation to be completed within the inter-measurement period. Failure to do so could result in unpredictable behavior.

2.4.4 Continuous mode limits

To take account of oscillator tolerances and internal processing overheads it is necessary to place the following constraints on continuous mode operations. The following equations define the minimum inter-measurement period to ensure correct operation:

Continuous range:

$$\text{SYSRANGE_MAX_CONVERGENCE_TIME} + 5 \leq \text{SYSRANGE_INTERMEASUREMENT_PERIOD} * 0.9$$

Continuous ALS:

$$\text{SYSALS_INTEGRATION_TIME} * 1.1 \leq \text{SYSALS_INTERMEASUREMENT_PERIOD} * 0.9$$

Interleaved mode:

$$(\text{SYSRANGE_MAX_CONVERGENCE_TIME} + 5) + (\text{SYSALS_INTEGRATION_TIME} * 1.1) \leq \text{SYSALS_INTERMEASUREMENT_PERIOD} * 0.9$$

Table 6. gives an example how to apply these limits in continuous interleaved mode operating at a sampling rate of 10 Hz.

Table 6. Interleaved mode limits (10 Hz operation)

Parameter	Period (ms)
SYSALS__INTERMEASUREMENT_PERIOD	100
Effective ALS INTERMEASUREMENT PERIOD	90
SYSRANGE__MAX_CONVERGENCE_TIME	30
Total RANGE EXECUTION TIME	35
SYSALS__INTEGRATION_TIME	50
Total ALS INTEGRATION TIME	55
TOTAL EXECUTION TIME	90

2.5 Range timing

Figure 12 gives a breakdown of total execution time for a single range measurement.

- The pre-calibration phase is fixed (3.2 ms).
- The range convergence time is variable and depends on target distance/reflectance (see Table 7).
- The recommended readout averaging period is 4.3 ms. Readout averaging helps to reduce measurement noise. The recommended setting for READOUT__AVERAGING_SAMPLE_PERIOD{0x10A} is 48^(c) but is programmable in the range 0-255. Note however that lower settings will result in increased noise.

Note: When a target is detected, register RESULT__RANGE_RETURN_CONV_TIME{0x80} returns the actual convergence time before readout averaging. Range convergence and readout averaging must be completed within the specified max convergence time.

Figure 12. Total range execution time

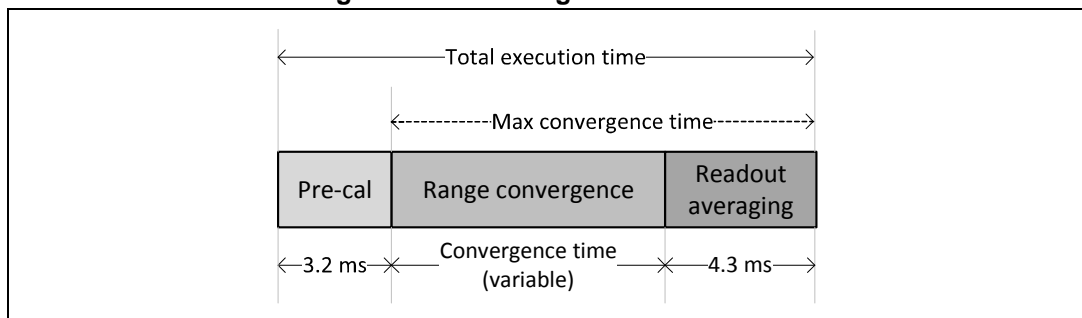

c. Default readout averaging period is calculated as follows: $1300 \mu\text{s} + (48 \times 64.5 \mu\text{s}) = 4.3 \text{ ms}$

Table 7. Typical range convergence time (ms)

Range (mm)	Target reflectance			
	3%	5%	17%	88%
10	0.43	0.33	0.18	0.18
20	0.94	0.73	0.28	0.18
30	1.89	1.40	0.51	0.18
40	3.07	2.25	0.81	0.18
50	4.35	3.24	1.18	0.24
60	5.70	4.22	1.60	0.32
70	7.07	5.35	2.07	0.49
80	8.41	6.45	2.58	0.50
90	9.58	7.56	3.14	0.61
100	10.73	8.65	3.69	0.73

2.6 Interrupt modes

The VL6180X can be configured to generate an ALS or range interrupt flag under any of the following conditions:

- New sample ready
- Level low (`RESULT__RANGE_VAL < SYSRANGE__THRESH_LOW`)
- Level high (`RESULT__RANGE_VAL > SYSRANGE__THRESH_HIGH`)
- Out of window (`RESULT__RANGE_VAL < SYSRANGE__THRESH_LOW`) OR (`RESULT__RANGE_VAL > SYSRANGE__THRESH_HIGH`)

In new sample ready mode, an interrupt flag will be raised at the end of every measurement irrespective of whether the measurement is valid or if an error has occurred. This mode is particularly useful during development and debug. In level interrupt mode the system will raise an interrupt flag if either a low or high programmable threshold has been crossed. Out of window interrupt mode activates both high and low level thresholds allowing a window of operation to be specified. Interrupt modes for Range and ALS are configured via register `SYSTEM__INTERRUPT_CONFIG_GPIO{0x14}`.

Note: In level or window interrupt modes range errors will only trigger an interrupt if the logical conditions described above are met.

2.7 Range error codes

The system carries out a number of range checks during every range measurement to ensure the validity of each range result. Register `RESULT__RANGE_STATUS{0x4D}` returns an error code if one of the checks fails. [Table 8](#) gives a summary of the possible error codes.

Table 8. Range error codes

Bits [7:4]	Error code	Description	Range (mm)
0	No error	Valid measurement	0 - 200 ⁽¹⁾
1-5	System error	System error detected. No measurement possible.	255
6	Early convergence estimate	ECE check failed	255
7	Max convergence	System did not converge before the specified max. convergence time limit	255
8	Range ignore	Ignore threshold check failed	255
9-10	Not used	-	-
11	SNR	Ambient conditions too high. Measurement invalidated	255
12	Raw range underflow	RESULT__RANGE_RAW < 0 (because offset is programmable a negative range result is possible)	0
13	Raw range overflow	RESULT__RANGE_RAW is out of range. This occurs typically around 200 mm	255
14	Range underflow	RESULT__RANGE_VAL < 0 (because offset is programmable a negative range result is possible)	0
15	Range overflow	RESULT__RANGE_VAL is out of range. This occurs typically around 200 mm	255

1. Range overflow occurs typically around 200 mm.

2.8 Range checks

Error codes 6, 8 and 11 in [Table 8](#) are configurable by the user. They can be enabled/disabled via register `SYSRANGE__RANGE_CHECK_ENABLES{0x2D}` by setting or clearing the appropriate bit. The register default is 0x11 i.e, ECE and SNR enabled.

2.8.1 Early convergence estimate (ECE)

Early convergence estimate (ECE) is a programmable feature designed to minimize power consumption when there is no target in the field-of-view (FOV).

The system is said to have 'converged' (i.e. range acquired), when the convergence threshold^(d) is reached before the max. convergence time limit (see [Figure 13](#)). This ratio specifies the minimum return signal rate required for convergence. If there is no target in the FOV, the system will continue to operate until the max. convergence time limit is reached before switching off thereby consuming power. With ECE enabled, the system estimates the

d. For standard ranging, the convergence threshold is set to 15360. The convergence threshold register is not accessible by the user.

return signal rate 0.5 ms after the start of every measurement. If it is below the ECE threshold, the measurement is aborted and an ECE error is flagged.

Figure 13. Early convergence estimate (ECE)

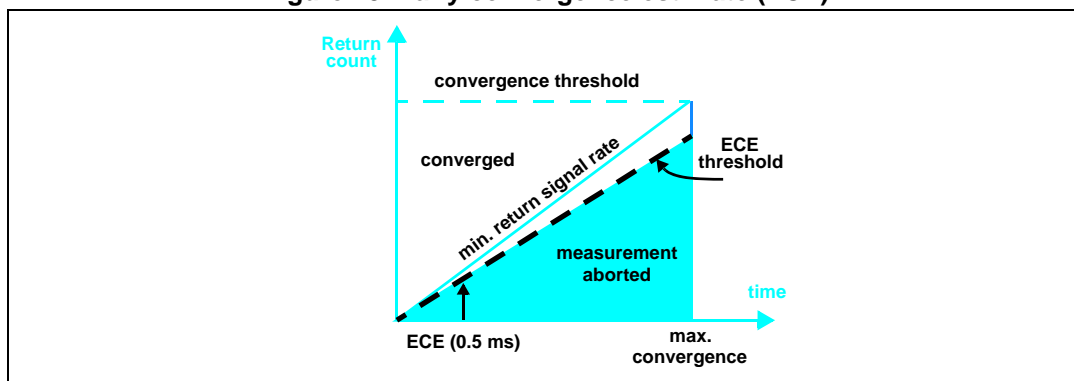

ECE is enabled by setting bit 0 of `SYSRANGE__RANGE_CHECK_ENABLES{0x02D}`. If enabled, the ECE threshold must be specified. To set the ECE threshold 20% below the minimum convergence rate, the ECE threshold is calculated as follows:

$$\text{ECE threshold} = \frac{80\% \times 0,5 \times 15360}{\text{SYSRANGE_MAX_CONVERGENCE_TIME (in ms)}}$$

The 16-bit ECE threshold should be written to `SYSRANGE__EARLY_CONVERGENCE_ESTIMATE{0x22}`. For example, if `SYSRANGE__MAX_CONVERGENCE_TIME{0x1c}` is set to 30 ms, the ECE threshold is 204. If the return count is less than 204 after 0.5 ms, the measurement will be aborted.

Note: The optimum value for the ECE threshold should be determined in the final application.

2.8.2 Range ignore

In a system with cover glass, the return signal from the glass (cross-talk) may be sufficient to cause the system to converge and return a valid range measurement even when there is no target present. The range ignore feature is designed to ensure that the system does not range on the glass. (Cross-talk is described in more detail in [Section 2.12.2](#)).

The ignore threshold is enabled by setting bit 1 of `SYSRANGE__RANGE_CHECK_ENABLES{0x02D}`. If enabled, the ignore threshold must be specified. In the follow example, the ignore threshold is set 20% above the system cross-talk:

$$\text{SYSRANGE__RANGE_IGNORE_THRESHOLD}\{0x26\} = \text{cross-talk (Mcps)} \times 120\%$$

A range ignore error will be flagged if the return signal rate is less than the ignore threshold. `SYSRANGE__RANGE_IGNORE_VALID_HEIGHT` should be set to 255.

Note: The optimum value for the ignore threshold should be determined in the final application.

2.8.3 Signal-to-noise ratio (SNR)

In high ambient conditions range accuracy can be impaired so the SNR threshold is used as a safety limit to invalidate range measurements where the ambient/signal ratio is considered too high. The default ambient/signal ratio limit is 10 (i.e. an SNR of 0.1) which is then encoded in 4.4 format as follows:

`SYSRANGE__MAX_AMBIENT_LEVEL_MULT{0x2C}` = 10 x 16 = 160

To enable the SNR check, set bit 4 in `SYSRANGE__RANGE_CHECK_ENABLES` (0x02D). A lower setting results in a more aggressive filter which will result in a lower effective range but greater accuracy. A higher setting results in a less aggressive filter which will result in a greater effective range but lower accuracy.

The SNR value can be calculated as follows:

$$\text{SNR} = \frac{\text{RESULT_RANGE_RETURN_SIGNAL_COUNT}\{0x6C\}}{\text{RESULT_RANGE_RETURN_AMB_COUNT}\{0x74\} * 6}$$

Note: The SNR value is the inverse of the ambient/signal ratio limit {0x2C}.

Note: The optimum value for SNR threshold should be determined in the final application.

2.9 Manual/autoVHV calibration

SPAD^(e) sensitivity is temperature dependent so VHV^(f) calibration is used to regulate SPAD sensitivity over temperature in order to minimize signal rate variation. VHV calibration is performed either manually by the host processor or automatically by internal firmware. Execution time is typically 200 μs so has no impact on normal operation.

A VHV calibration is run once at power-up and then automatically after every N range measurements defined by the `SYSRANGE__VHV_REPEAT_RATE{0x31}` register. AutoVHV calibration is disabled by setting this register to 0. Default is 255. If autoVHV is disabled it is recommended to run a manual VHV calibration periodically to recalibrate for any significant temperature variation. A manual VHV calibration is performed by setting `SYSRANGE__VHV_RECALBRATE{0x2E}` to 1. This register auto-clears. This operation should only be performed in software standby.

2.10 History buffer

The history buffer is a 8 x 16-bit memory which can be used to store the last 16 range measurements (8-bit) or 8 ALS samples (16-bit). Use of the history buffer is controlled via register `SYSTEM__HISTORY_CTRL{0x12}`. There are 3 basic functions:

- enable
- range or ALS selection
- clear buffer

e. Photon detectors - Single Photon Avalanche Diodes

f. VHV is an adjustable SPAD bias voltage and stands for Very High Voltage (typically around 14 V). Also sometimes referred to as CP (Charge Pump).

The buffer is read via eight 16-bit registers (RESULT_HISTORY_BUFFER_0{0x52} to RESULT_HISTORY_BUFFER_7{0x60}). The buffer holds the last 16 x 8-bit range or 8 x 16-bit ALS results as shown in [Table 9](#).

Table 9. History buffer

History buffer	Range		ALS
	(High byte)	(Low byte)	(Word)
0	Range [15] (newest)	Range [14]	ALS [7] (newest)
1	Range [13]	Range [12]	ALS [6]
2	Range [11]	Range [10]	ALS [5]
3	Range [9]	Range [8]	ALS [4]
4	Range [7]	Range [6]	ALS [3]
5	Range [5]	Range [4]	ALS [2]
6	Range [3]	Range [2]	ALS [1]
7	Range [1]	Range [0] (oldest)	ALS [0] (oldest)

Note: Only one data stream (ALS or range) can be buffered at one time. There is no associated time stamp information.

The clear buffer command is not immediate; it takes effect on the next range or ALS start command.

The history buffer works independently of interrupt control i.e. the history buffer records all new samples; its operation is unchanged in threshold and window modes.

2.11 Current consumption

[Table 10](#) gives an overview of current consumption in different operating states.

Table 10. Typical current consumption in different operating states

Mode	Current	Conditions
Hardware standby	< 1 μ A	Shutdown (GPIO0 = 0). No I ² C comms
Software standby	< 1 μ A	After MCU boot. Device ready
ALS	300 μ A	During integration
Ranging	1.7 mA	Average consumption during ranging ⁽¹⁾

1. 10 Hz sampling rate, 17% reflective target at 50 mm.

2.11.1 Ranging current consumption

[Figure 14](#) shows typical ranging current consumption of the VL6180X. Current consumption depends on target distance, target reflectance and sampling rate. The example shown here is based on default settings and a sampling rate of 10 Hz. The average current consumption for a 17% reflective target at 50 mm operating at 10 Hz is 1.7 mA. At different sampling rates

the current consumption scales accordingly i.e. the average current consumption at 1 Hz under the same conditions would be 0.17 mA.

Figure 14. Typical ranging current consumption (10 Hz sampling rate)

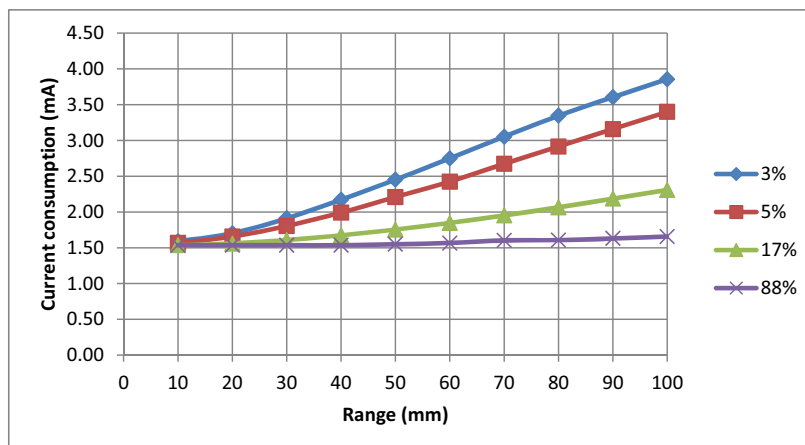

The minimum average current consumption in [Figure 14](#), is 1.5 mA, 0.5 mA of which comes from pre-calibration before each measurement and 1.0 mA from post-processing (readout averaging). Pre-calibration is a fixed overhead but readout averaging can be reduced or effectively disabled by setting the `READOUT__AVERAGING_SAMPLE_PERIOD{0x10A}` to zero (default setting is 48).

Note: Decreasing the `READOUT__AVERAGING_SAMPLE_PERIOD` will increase sampling noise. It is recommended that any change in setting be properly evaluated in the end application.

Minimum current consumption scales with sampling rate i.e. at a sampling rate of 1 Hz the current consumption associated with pre- and post-processing will be 0.15 µA.

2.11.2 Current consumption calculator

[Table 11](#) gives a breakdown of typical current consumption for pre-calibration, ranging and readout averaging.

Table 11. Breakdown of current consumption

Label	Phase	I (mA)	t (ms)	Q (µC) = I x t
Q ₁	Pre-calibration	13.0	3.2	41.6
Q ₂	Ranging	22.0	per ms	22.0 per ms
Q ₃	Readout averaging	25.0	per ms	25.0 per ms

Current consumption can then be calculated as follows:

$$I (\mu A) = \text{sampling_rate} * [Q_1 + (Q_2 * \text{RESULT_RANGE_RETURN_CONV_TIME in ms}) + Q_3 * (1.3 + (\text{READOUT_AVERAGING_SAMPLE_PERIOD} * 0.0645 \text{ ms}))]$$

[Table 7](#) gives typical convergence times for different target reflectance.

So, for example, `RESULT__RANGE_RETURN_CONV_TIME` for a 3% target at 50 mm is 4.35 ms. At 10 Hz sampling rate this gives:

$$I (\mu A) = 10 * [41.6 + (22 * 4.35) + 25 * (1.3 + (48 * 0.0645))] = 2472 \mu A$$

2.11.3 Current distribution

Table 12. shows how current consumption is distributed between the two supplies in ranging mode. AVDD_VCSEL supplies the VCSEL current and AVDD supplies all other functions.

Note: The VCSEL driver is pulsed at 100 MHz with a 33% duty cycle (see *Figure 15.*) so average current consumption on AVDD_VCSEL is one third of the peak.

Table 12. Current consumption on AVDD and AVDD_VCSEL

Power supply ⁽¹⁾	Current	Note
AVDD	14 mA	Average during active ranging
AVDD_VCSEL	8 mA ⁽²⁾	Average during active ranging (33% duty cycle).

- Normally, both supplies will be driven from a common source giving a peak instantaneous current demand of 38 mA.
- Peak emitter current during ranging is 24 mA.

Figure 15. VCSEL pulse duty cycle

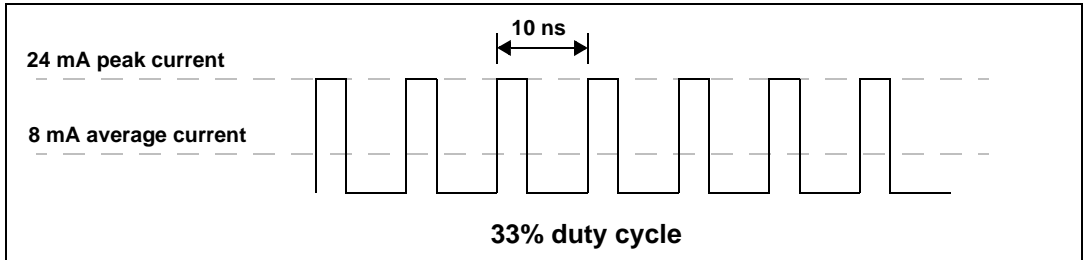

2.12 Other system considerations

This section describes part-to-part range offset and system cross-talk. In addition, a procedure for cross-talk calibration is given.

2.12.1 Part-to-part range offset

The VL6180X is factory calibrated to produce an absolute linear range output as shown in [Figure 16](#). The part-to-part range offset is calibrated during manufacture and stored in `SYSRANGE__PART_TO_PART_RANGE_OFFSET{0x24}` (two's complement). `RESULT__RANGE_RAW{0x64}` reports the range with the part-to-part offset already applied.

Figure 16. Part-to-part range offset

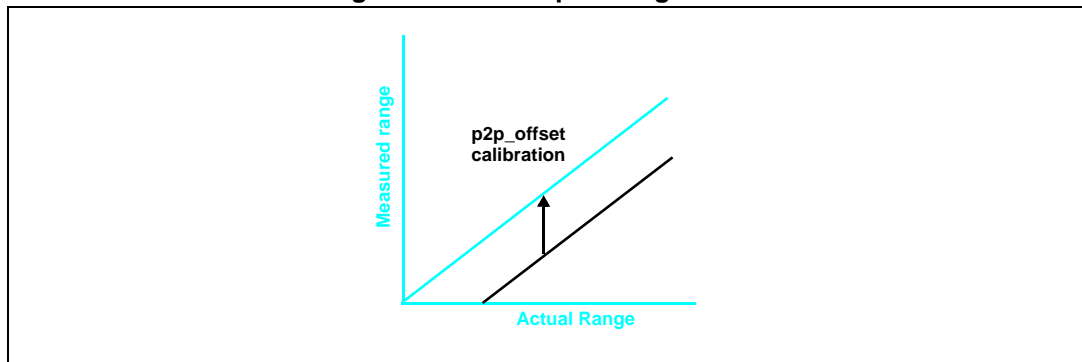

2.12.2 Cross-talk

Cross-talk is defined as the signal return from the cover glass. The magnitude of the cross-talk depends on the type of glass, air gap and filter material. Cross-talk results in a range error (see [Figure 17](#)) which is proportional to the ratio of the cross-talk to the signal return from the target. The true range is recovered by applying automatic cross-talk compensation.

Figure 17. Cross-talk compensation

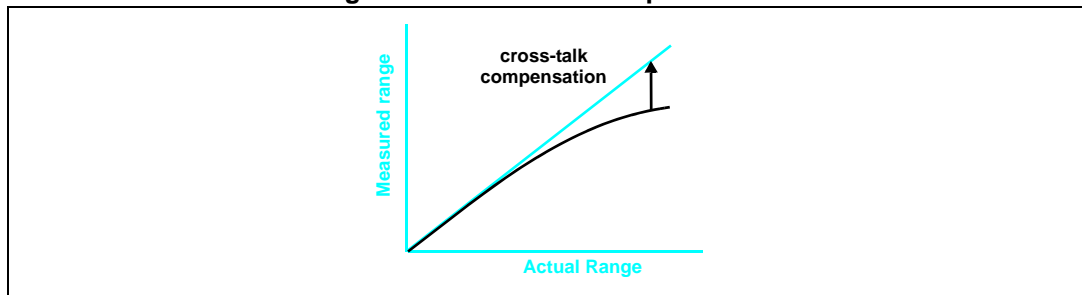

To enable cross-talk compensation it is necessary to write the calibrated cross-talk value to `SYSRANGE__CROSSTALK_COMPENSATION_RATE{0x1E}` in 9.7 format. A cross-talk calibration procedure is described in [Section 2.12.4](#).

2.12.3 Offset calibration procedure

Complete steps 1-3 to see if part-to-part offset calibration is required.

1. Position a white target (88% reflectance^(g)) at a distance of 50 mm from the top of the cover glass.
2. Perform a minimum of 10 range measurements and compute the average range (from `RESULT__RANGE_VAL{0x62}`).
3. If the average range is within the 50 ± 3 mm, offset calibration is not required. Otherwise, complete this calibration procedure.
4. Set `SYSRANGE__PART_TO_PART_RANGE_OFFSET{0x24} = 0`.
5. Perform a minimum of 10 range measurements and compute the average range (from `RESULT__RANGE_VAL{0x62}`).
6. Calculate the part-to-part offset as follows:

$$\text{part-to-part offset} = 50 \text{ mm} - \text{average range}$$

7. Write the part-to-part offset result (in two's complement notation) to `SYSRANGE__PART_TO_PART_RANGE_OFFSET`.

2.12.4 Cross-talk calibration procedure

This section describes a procedure for calibrating system cross-talk.

1. Perform offset calibration if required (see [Section 2.12.3](#)).

Note: If the offset is incorrectly calibrated, cross-talk calibration will be inaccurate.

2. Position a black target (3% reflectance^(h)) at a distance of 100 mm from the top of the cover glass.
3. Ensure `SYSRANGE__CROSSTALK_COMPENSATION_RATE{0x1E} = 0`.
4. Perform a minimum of 10 range measurements and compute the average return rate (from `RESULT__RANGE_RETURN_RATE{0x66}`) and the average range (from `RESULT__RANGE_VAL{0x62}`).
5. Calculate the cross-talk factor as follows:

$$\text{cross-talk (in Mcps)} = \text{average return rate} \times \left(1 - \frac{\text{average range}}{100 \text{ mm}}\right)$$

6. Write the cross-talk result in 9.7 format to `SYSRANGE__CROSSTALK_COMPENSATION_RATE`.

For example, cross-talk = 0.4 Mcps => $0.4 \times 128 = 51.2$. Write 51 to `SYSRANGE__CROSSTALK_COMPENSATION_RATE`.

Note: Cross-talk compensation is only applied to targets above 20 mm. This is to ensure that cross-talk correction is not applied to near targets where the signal rate is decreasing. The cross-talk height qualifier is defined in register `SYSRANGE__CROSSTALK_VALID_HEIGHT{0x21}`. The default is 20 mm.

g. Target reflectance should be high but absolute value is not critical.

h. Target reflectance should be low but absolute value is not critical.

2.12.5 Cross-talk limit

A practical limit for cross-talk is < 3.0 Mcps. This is based on two factors:

1. The return rate for a 3% reflective target at 100 mm without glass is typically around 1.5 Mcps. If glass is added with a cross-talk of 3.0 Mcps, the resultant return rate will be 4.5 Mcps. This results in a cross-talk correction factor of x3 so for a 100 mm target the raw range will be in the region of 30 mm. To ensure the `SYSRANGE__CROSSTALK_VALID_HEIGHT` restriction is not breached, the minimum raw range allowing for noise margin is around 30 mm.
2. A cross-talk correction factor of x3 also means that any range noise will be multiplied by 3 so noise also becomes a limiting factor.

2.12.6 Cross-talk vs air gap

[Figure 18](#) shows the typical cross-talk vs air gap using ST cover glass with oval aperture. Above 2.5 mm, the cross-talk rises rapidly.

Figure 18. Cross-talk vs air gap

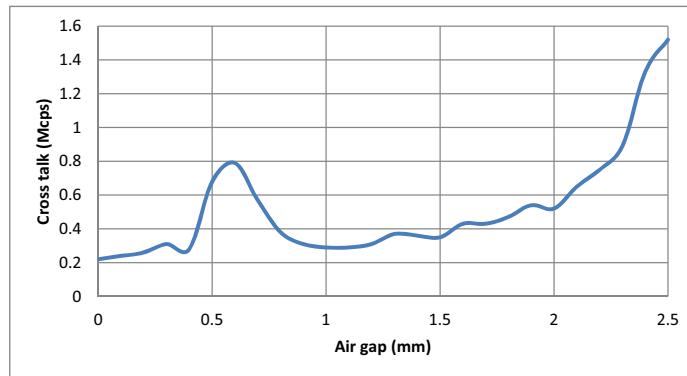

2.13 Ambient light sensor (ALS)

The VL6180X contains an ambient light sensor capable of measuring the ambient light level over a wide dynamic range. This section describes the main features of the ALS. The ALS performance specification can be found in [Section 4.2](#).

2.13.1 Field of view

[Figure 19](#) shows the ALS field of view which is typically 42 degrees (half angle, 40% of peak) in both X and Y.

Figure 19. ALS angular response

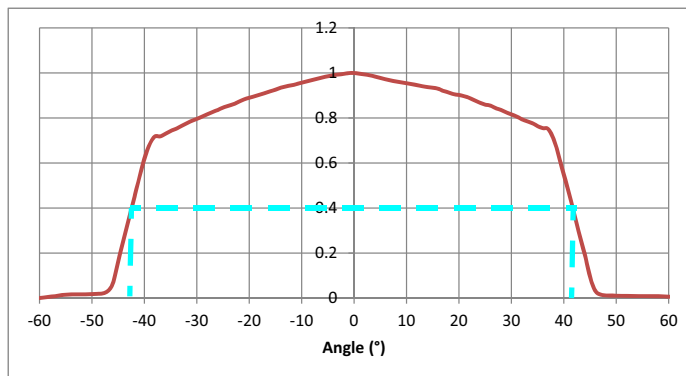

2.13.2 Spectral response

The spectral response of the ALS compared to photopic response is shown in [Figure 20](#).

Figure 20. ALS spectral response

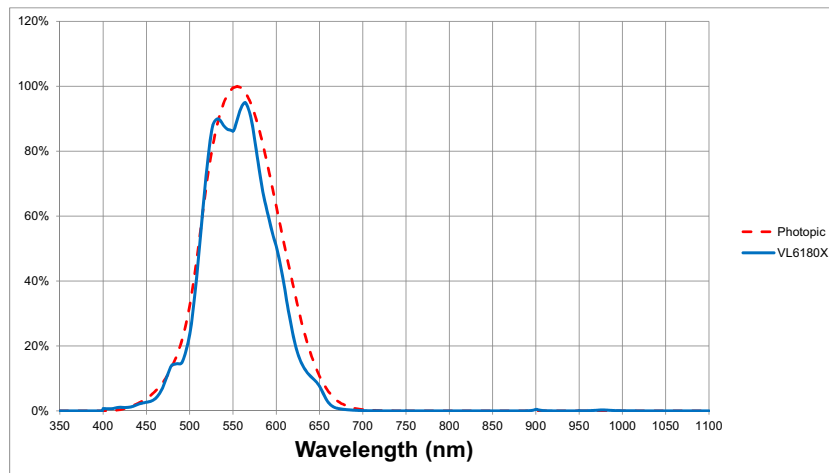

2.13.3 ALS dynamic range

Table 13 shows the range of measurable light at all gains both with and without glass. In most applications operating at a single gain setting should be possible.

Table 13. ALS dynamic range⁽¹⁾

Analogue gain setting	Dynamic range (no glass)		Dynamic range (10% transmissive glass)	
	Min. (Lux) ⁽²⁾	Max. (Lux)	Minimum (Lux)	Maximum (Lux)
1	3.20	20800	32.0	>100,000
1.25	2.56	16640	25.6	>100,000
1.67	1.93	12530	19.3	>100,000
2.5	1.28	8320	12.8	83,200
5	0.64	4160	6.4	41,600
10	0.32	2080	3.2	20,800
20	0.16	1040	1.6	10,400
40	0.08	520	0.8	5,200

1. ALS lux resolution = 0.32 lux/count

2. Minimum of 10 counts

2.13.4 ALS count to lux conversion

The output from the ambient light sensor is a 16-bit register, `RESULT__ALS_VAL{0x50}`. The count output is proportional to the light level and can be converted into lux using the following equation:

$$\text{Light level (in lux)} = \text{ALS lux resolution} \times \frac{\text{RESULT_ALS_VAL}}{\text{Analog gain}} \times \frac{100 \text{ ms}}{\text{ALS integration time}}$$

The factory calibrated ALS lux resolution is 0.32 lux/count for an analog gain of 1 (calibrated without glass). The ALS lux resolution will require re-calibration in the final system where cover glass is used. This can be done by recording the count output with and without glass under the same conditions and multiplying the ALS lux resolution by the ratio of the two counts as follows:

$$\text{ALS lux resolution (with glass)} = \frac{\text{RESULT_ALS_VAL (without glass)}}{\text{RESULT_ALS_VAL (with glass)}} \times \text{ALS lux resolution (without glass)}$$

2.13.5 Integration period

The integration period is the time over which a single ALS measurement is made. The default integration period is 100ms. Integration times in the range 50-100 ms are recommended to reduce impact of light flicker from artificial lighting.

2.13.6 ALS gain selection

Eight analog gain settings are available which can be selected manually depending on the range and resolution required. [Table 14](#) shows the actual characterized gains versus the design targets. If a gain setting other than gain 20 is used, marginally greater accuracy can be achieved by using the actual gain values in the light level equation in [Section 2.13.4](#) when calculating the lux light level.

Table 14. Actual gain values

Register setting {0x3F}	Analog gain setting	Actual gain values
0x46	1	1.01
0x45	1.25	1.28
0x44	1.67	1.72
0x43	2.5	2.60
0x42	5	5.21
0x41	10	10.32
0x40	20	20
0x47	40	40

Note: The upper nibble of `SYSALS__ANALOGUE_GAIN` should always be set to 0x4.

3 Electrical characteristics

3.1 Absolute maximum ratings

Table 15. Absolute maximum ratings

Parameter	Min.	Typ.	Max.	Unit
AVDD	-0.5	-	3.6	V
AVDD_VCSEL	-0.5	-	3.6	V
SCL, SDA, GPIO0 and GPIO1	-0.5	-	3.6	V

Note: Stresses above those listed in Table 15. may cause permanent damage to the device. This is a stress rating only and functional operation of the device at these or any other conditions above those indicated in the operational sections of the specification is not implied. Exposure to absolute maximum rating conditions for extended periods may affect device reliability.

3.2 Normal operating conditions

Table 16. Normal operating conditions

Parameter	Min.	Typ.	Max.	Unit
Voltage (AVDD and AVDD_VCSEL)				
Voltage (optimum operating)	2.7	2.8	2.9	V
Voltage (functional operating)	2.6	2.8	3.0	V
Temperature				
Temperature (optimum operating)	-10		+60	°C
Temperature (functional operating)	-20	-	+70	°C
Temperature (test)	+21	-	+25	°C
Temperature (storage)	-40	-	+85	°C

3.3 Current consumption

Table 17. Current consumption⁽¹⁾

Parameter	Min.	Typ.	Max.	Unit
Hardware Standby	-	-	1	μA
Software Standby	-	-	1	μA
ALS operation	-	300	350	μA

1. Measured at room temperature (23°C)

3.4 Electrical characteristics

Table 18. Digital I/O electrical characteristics

Symbol	Parameter	Minimum	Typical	Maximum	Unit
CMOS digital I/O (SDA, SCL, GPIO0 and GPIO1)					
V _{IL}	Low level input voltage	-0.5	-	0.6	V
V _{IH}	High level input voltage	1.12	-	AVDD+0.5	V
V _{OL}	Low level output voltage (8mA load)	-	-	0.4	V
V _{OH}	High level output voltage (8mA load)	AVDD-0.4	-	-	V
I _{IL}	Low level input current	-	-	-10	μA
I _{IH}	High level input current	-	-	10	μA

4 Performance specification

4.1 Proximity ranging (0 to 100mm)

The following table specifies ranging performance up to 100mm. Ranging beyond 100mm is possible with certain target reflectances and ambient conditions but not guaranteed. These results are derived from characterization of both typical and corner samples (representative of worst case process conditions).

Unless specified otherwise, all results were performed at room temperature (23°C), nominal voltage (2.8V) and in the dark. Results are based on the average of 100 measurements for a 17% reflective target @ 50mm.

Table 19. Ranging specification

Parameter	Min.	Typ.	Max.	Unit
Noise ⁽¹⁾	-	-	2.0	mm
Range offset error ⁽²⁾	-	-	13	mm
Temperature dependent drift ⁽³⁾	-	9	15	mm
Voltage dependent drift ⁽⁴⁾	-	3	5	mm
Convergence time ⁽⁵⁾	-	-	15	ms

1. Maximum standard deviation of 100 measurements
2. Maximum offset drift after 3 reflow cycles. This error can be removed by re-calibration in the final system
3. Tested over optimum operating temperature range (see [Table 16.: Normal operating conditions](#))
4. Tested over optimum operating voltage range (see [Table 16.: Normal operating conditions](#))
5. Based on a 3% reflective target @ 100 mm

4.1.1 Max range vs. ambient light level

The data shown in this section is worst case data **for reference only**.

[Table 20](#) shows the worst case maximum range achievable under different ambient light conditions

Table 20. Worst case max range vs. ambient 0 to 100mm⁽¹⁾⁽²⁾

Target reflectance	In the dark ⁽³⁾	Worst case indoor light (1 kLux diffuse halogen)	High ambient light (5 kLux diffuse halogen)	Unit
3%	> 100	> 80	> 40	mm
5%	> 100	> 90	> 45	mm
17%	> 100	> 100	> 60	mm
88%	> 100	> 100	> 70	mm

1. Tested in an integrating sphere (repeatable lab test, not representative of real world ambient light) at 1 kLux and 5 kLux (halogen light source) using 80 x 80 mm targets. Due to high IR content, 5 kLux halogen light approximates to 10 kLux to 15 kLux natural sunlight.
2. SNR limit of 0.1 applied. Note: maximum range could be increased by reducing the SNR limit to 0.06
3. Also applicable to lighting conditions with low IR content e.g typical office fluorescent lighting

4.2 ALS performance

The following table specifies ALS performance. These results are derived from characterization of typical samples (without cover glass). Unless specified otherwise, all tests were performed at room temperature (23°C), nominal voltage (2.8V) and using a halogen light source.

Table 21. ALS performance

Parameter	Min.	Typ.	Max.	Unit
ALS sensitivity ⁽¹⁾	0.28	0.32	0.36	Lux/count
Angular response ⁽²⁾	-	42	-	degrees
Spectral response	-	photopic	-	-
Dynamic Range ⁽³⁾	0.002	-	20971	Lux
Linearity error (1 to 300 lux) ⁽⁴⁾	-	-	5	%
Linearity error (300 to 7500 lux) ⁽⁴⁾	-	-	10	%
Gain error (@ gain 20)	-	-	1	%
Gain error (gains 1 to 10)	-	-	7	%

1. 535nm LED @ 1 kLux. Measured @ gain 20.
2. Half angle. 40% transmission.
3. Minimum of one count at gain 40 and 400 ms ALS integration time.
4. Test conditions: -10°C to +60°C; analog gains 1 to 20

5 I²C control interface

The VL6180X is controlled over an I²C interface. The default I²C address is 0x29 (7-bit). This section describes the I²C protocol.

Figure 21. Serial interface data transfer protocol

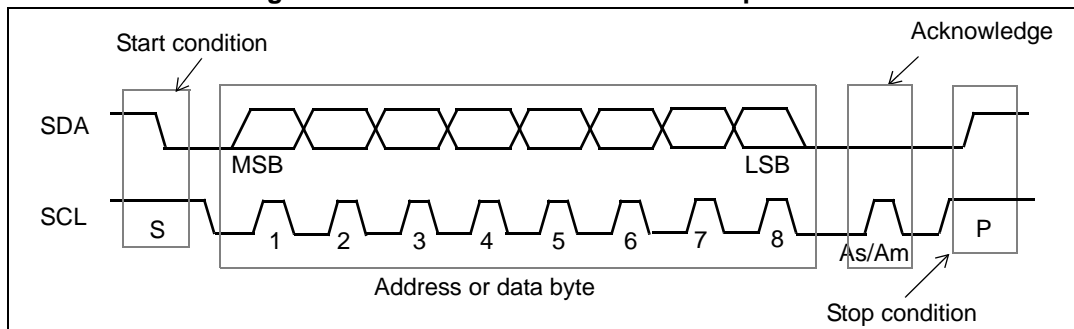

Information is packed in 8-bit packets (bytes) always followed by an acknowledge bit, As for sensor acknowledge and Am for master acknowledge. The internal data is produced by sampling SDA at a rising edge of SCL. The external data must be stable during the high period of SCL. The exceptions to this are start (S) or stop (P) conditions when SDA falls or rises respectively, while SCL is high.

A message contains a series of bytes preceded by a start condition and followed by either a stop or repeated start (another start condition but without a preceding stop condition) followed by another message. The first byte contains the device address (0x52) and also specifies the data direction. If the least significant bit is low (0x52) the message is a master write to the slave. If the lsb is set (0x53) then the message is a master read from the slave.

Figure 22. I²C device address

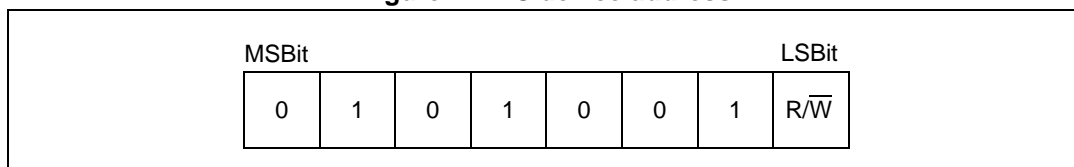

All serial interface communications with the sensor must begin with a start condition. The sensor acknowledges the receipt of a valid address by driving the SDA wire low. The state of the read/write bit (lsb of the address byte) is stored and the next byte of data, sampled from SDA, can be interpreted. During a write sequence the second and third bytes received provide a 16-bit index which points to one of the internal 8-bit registers.

Figure 23. Single location, single write)

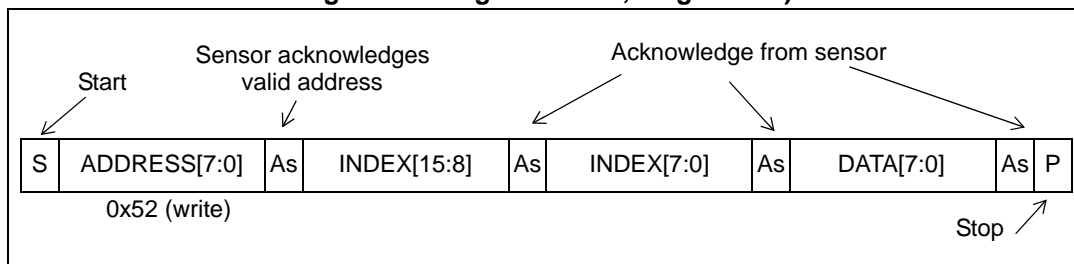

As data is received by the slave it is written bit by bit to a serial/parallel register. After each data byte has been received by the slave, an acknowledge is generated, the data is then stored in the internal register addressed by the current index.

During a read message, the contents of the register addressed by the current index is read out in the byte following the device address byte. The contents of this register are parallel loaded into the serial/parallel register and clocked out of the device by the falling edge of SCL.

Figure 24. Single location, single read

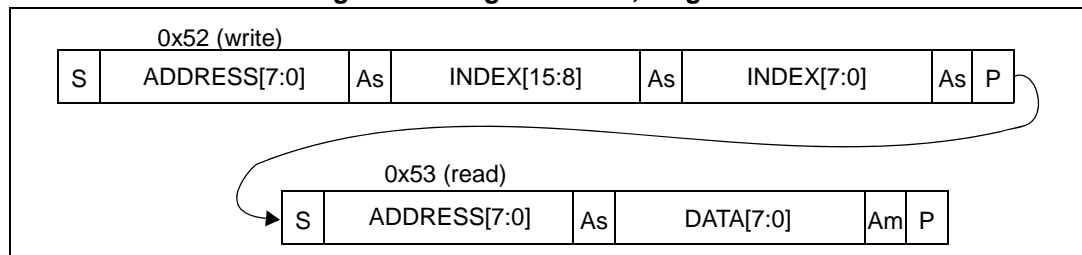

At the end of each byte, in both read and write message sequences, an acknowledge is issued by the receiving device (that is, the sensor for a write and the master for a read).

A message can only be terminated by the bus master, either by issuing a stop condition or by a negative acknowledge (that is, **not** pulling the SDA line low) after reading a complete byte during a read operation.

The interface also supports auto-increment indexing. After the first data byte has been transferred, the index is automatically incremented by 1. The master can therefore send data bytes continuously to the slave until the slave fails to provide an acknowledge or the master terminates the write communication with a stop condition. If the auto-increment feature is used the master does **not** have to send address indexes to accompany the data bytes.

Figure 25. Multiple location write

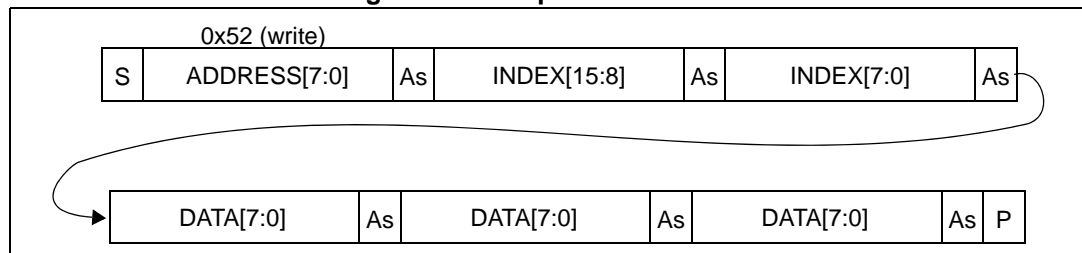
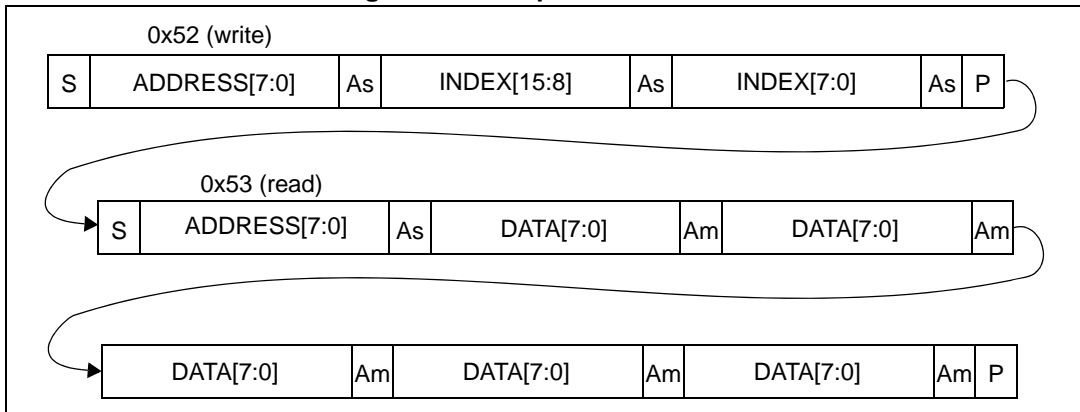

Figure 26. Multiple location read



6 Device registers

This section describes in detail all user accessible device registers. Registers are grouped by function as shown in [Table 22](#). to make them easier to read but also to simplify multi-byte read/write I²C accesses (burst mode). More details in [Section 5](#). Reset values are given for each register which denotes the register value in software standby.

Table 22. Register groups

Register group	Address range
IDENTIFICATION	0x00 - 0x0F
SYSTEM SETUP	0x10 - 0x17
RANGE SETUP	0x18 - 0x37
ALS SETUP	0x38 - 0x40
RESULTS	0x4D - 0x80

Note that registers can be 8-,16- or 32-bit. Multi-byte registers are always addressed in ascending order with MSB first as shown in [Table 23](#).

Table 23. 32-bit register example

Register address	Byte
Address	MSB
Address + 1	..
Address + 2	..
Address + 3	LSB

6.1 Register encoding formats

Some registers are encoded to allow rational numbers to be expressed efficiently. [Table 24](#) gives an explanation of 9.7 and 4.4 encoding formats.

Table 24. 9.7 and 4.4 register formats

Format	Description
4.4	8 bits = 4 integer bits + 4 fractional bits (stored as 1 byte) Encoding example: the value 4.2 is multiplied by 16 (2 ⁴) rounded and stored as 67 decimal. Decoding example: 67 is divided by 16 = 4.19.
9.7	16 bits = 9 integer bits + 7 fractional bits (stored over 2 bytes) Encoding example: the value 4.2 is multiplied by 128 (2 ⁷) rounded and stored as 537 decimal. Decoding example: 537 is divided by 128 = 4.19.

Table 25. Register summary

Offset	Register name	Reference
0x000	IDENTIFICATION__MODEL_ID	Section 6.2.1 on page 43
0x001	IDENTIFICATION__MODEL_REV_MAJOR	Section 6.2.2 on page 43
0x002	IDENTIFICATION__MODEL_REV_MINOR	Section 6.2.3 on page 43
0x003	IDENTIFICATION__MODULE_REV_MAJOR	Section 6.2.4 on page 44
0x004	IDENTIFICATION__MODULE_REV_MINOR	Section 6.2.5 on page 44
0x006	IDENTIFICATION__DATE_HI	Section 6.2.6 on page 44
0x007	IDENTIFICATION__DATE_LO	Section 6.2.7 on page 45
0x008:0x009	IDENTIFICATION__TIME	Section 6.2.8 on page 45
0x010	SYSTEM__MODE_GPIO0	Section 6.2.9 on page 46
0x011	SYSTEM__MODE_GPIO1	Section 6.2.10 on page 47
0x012	SYSTEM__HISTORY_CTRL	Section 6.2.11 on page 48
0x014	SYSTEM__INTERRUPT_CONFIG_GPIO	Section 6.2.12 on page 49
0x015	SYSTEM__INTERRUPT_CLEAR	Section 6.2.13 on page 49
0x016	SYSTEM__FRESH_OUT_OF_RESET	Section 6.2.14 on page 50
0x017	SYSTEM__GROUPED_PARAMETER_HOLD	Section 6.2.15 on page 50
0x018	SYSRANGE__START	Section 6.2.16 on page 51
0x019	SYSRANGE__THRESH_HIGH	Section 6.2.17 on page 51
0x01A	SYSRANGE__THRESH_LOW	Section 6.2.18 on page 52
0x01B	SYSRANGE__INTERMEASUREMENT_PERIOD	Section 6.2.19 on page 52
0x01C	SYSRANGE__MAX_CONVERGENCE_TIME	Section 6.2.20 on page 52
0x01E	SYSRANGE__CROSSTALK_COMPENSATION_RATE	Section 6.2.21 on page 53
0x021	SYSRANGE__CROSSTALK_VALID_HEIGHT	Section 6.2.22 on page 53
0x022	SYSRANGE__EARLY_CONVERGENCE_ESTIMATE	Section 6.2.23 on page 53
0x024	SYSRANGE__PART_TO_PART_RANGE_OFFSET	Section 6.2.24 on page 54
0x025	SYSRANGE__RANGE_IGNORE_VALID_HEIGHT	Section 6.2.25 on page 54
0x026	SYSRANGE__RANGE_IGNORE_THRESHOLD	Section 6.2.26 on page 54
0x02C	SYSRANGE__MAX_AMBIENT_LEVEL_MULT	Section 6.2.27 on page 55
0x02D	SYSRANGE__RANGE_CHECK_ENABLES	Section 6.2.27 on page 55
0x02E	SYSRANGE__VHV_RECALIBRATE	Section 6.2.29 on page 56
0x031	SYSRANGE__VHV_REPEAT_RATE	Section 6.2.30 on page 56
0x038	SYSALS__START	Section 6.2.31 on page 57
0x03A	SYSALS__THRESH_HIGH	Section 6.2.32 on page 57
0x03C	SYSALS__THRESH_LOW	Section 6.2.33 on page 58

Table 25. Register summary (continued)

Offset	Register name	Reference
0x03E	SYSALS__INTERMEASUREMENT_PERIOD	Section 6.2.34 on page 58
0x03F	SYSALS__ANALOGUE_GAIN	Section 6.2.35 on page 59
0x040	SYSALS__INTEGRATION_PERIOD	Section 6.2.36 on page 59
0x04D	RESULT__RANGE_STATUS	Section 6.2.37 on page 60
0x04E	RESULT__ALS_STATUS	Section 6.2.38 on page 61
0x04F	RESULT__INTERRUPT_STATUS_GPIO	Section 6.2.39 on page 62
0x050	RESULT__ALS_VAL	Section 6.2.40 on page 62
0x052:0x060 (0x2)	RESULT__HISTORY_BUFFER_x	Section 6.2.41 on page 63
0x062	RESULT__RANGE_VAL	Section 6.2.42 on page 64
0x064	RESULT__RANGE_RAW	Section 6.2.43 on page 64
0x066	RESULT__RANGE_RETURN_RATE	Section 6.2.44 on page 64
0x068	RESULT__RANGE_REFERENCE_RATE	Section 6.2.45 on page 65
0x06C	RESULT__RANGE_RETURN_SIGNAL_COUNT	Section 6.2.46 on page 65
0x070	RESULT__RANGE_REFERENCE_SIGNAL_COUNT	Section 6.2.47 on page 66
0x074	RESULT__RANGE_RETURN_AMB_COUNT	Section 6.2.48 on page 66
0x078	RESULT__RANGE_REFERENCE_AMB_COUNT	Section 6.2.49 on page 66
0x07C	RESULT__RANGE_RETURN_CONV_TIME	Section 6.2.50 on page 67
0x080	RESULT__RANGE_REFERENCE_CONV_TIME	Section 6.2.51 on page 67
0x10A	READOUT__AVERAGING_SAMPLE_PERIOD	Section 6.2.52 on page 67
0x119	FIRMWARE__BOOTUP	Section 6.2.52 on page 67
0x120	FIRMWARE__RESULT_SCALER	Section 6.2.53 on page 68
0x212	I2C_SLAVE__DEVICE_ADDRESS	Section 6.2.55 on page 68
0x2A3	INTERLEAVED_MODE__ENABLE	Section 6.2.56 on page 69

6.2 Register descriptions

6.2.1 IDENTIFICATION__MODEL_ID

7	6	5	4	3	2	1	0
identification__model_id							
R/W							

Address: 0x000

Type: R/W

Reset: 0xB4

Description:

[7:0]	identification__model_id: Device model identification number. 0xB4 = VL6180X
-------	--

6.2.2 IDENTIFICATION__MODEL_REV_MAJOR

7	6	5	4	3	2	1	0
RESERVED					identification__model_rev_major		
R					R/W		

Address: 0x001

Type: R/W

Reset: 0x1, register default overwritten at boot-up by NVM contents.

Description:

[2:0]	identification__model_rev_major: Revision identifier of the Device for major change.
-------	--

6.2.3 IDENTIFICATION__MODEL_REV_MINOR

7	6	5	4	3	2	1	0
RESERVED					identification__model_rev_minor		
R					R/W		

Address: 0x002

Type: R/W

Reset: 0x3, register default overwritten at boot-up by NVM contents.

Description:

[2:0]	identification__model_rev_minor: Revision identifier of the Device for minor change. IDENTIFICATION__MODEL_REV_MINOR = 3 for latest ROM revision
-------	---

6.2.4 IDENTIFICATION__MODULE_REV_MAJOR

7	6	5	4	3	2	1	0
RESERVED					identification__module_rev_major		
R					R/W		

Address: 0x003

Type: R/W

Reset: 0x1, register default overwritten at boot-up by NVM contents.

Description:

[2:0]	identification__module_rev_major: Revision identifier of the Module Package for major change. Used to store NVM content version. Contact ST for current information.
-------	--

6.2.5 IDENTIFICATION__MODULE_REV_MINOR

7	6	5	4	3	2	1	0
RESERVED					identification__module_rev_minor		
R					R/W		

Address: 0x004

Type: R/W

Reset: 0x2, register default overwritten at boot-up by NVM contents.

Description:

[2:0]	identification__module_rev_minor: Revision identifier of the Module Package for minor change. Used to store NVM content version. Contact ST for current information.
-------	--

6.2.6 IDENTIFICATION__DATE_HI

7	6	5	4	3	2	1	0
identification__year				identification__month			
R/W				R/W			

Address: 0x006

Type: R/W

Reset: 0xYY, register default overwritten at boot-up by NVM contents.

Description: Part of the register set that can be used to uniquely identify a module.

[7:4]	identification__year: Last digit of manufacturing year (bits[3:0]).
[3:0]	identification__month: Manufacturing month (bits[3:0]).

6.2.7 IDENTIFICATION__DATE_LO

7	6	5	4	3	2	1	0
identification__day				identification__phase			
R/W				R/W			

Address: 0x007

Type: R/W

Reset: 0xYY, register default overwritten at boot-up by NVM contents.

Description: Part of the register set that can be used to uniquely identify a module.

[7:3]	identification__day: Manufacturing day (bits[4:0]).
[2:0]	identification__phase: Manufacturing phase identification (bits[2:0]).

6.2.8 IDENTIFICATION__TIME

15	14	13	12	11	10	9	8	7	6	5	4	3	2	1	0
identification__time															
R/W															

Address: 0x008:0x009

Type: R/W

Reset: 0xYYYY, register default overwritten at boot-up by NVM contents.

Description: Part of the register set that can be used to uniquely identify a module.

[15:0]	identification__time: Time since midnight (in seconds) = register_value * 2
--------	---

6.2.9 SYSTEM__MODE_GPIO0

7	6	5	4	3	2	1	0
RESERVED	system__gpio0_is_xshutdown	system__gpio0_polarity	system__gpio0_select			RESERVED	
R	R/W	R/W	R/W			R/W	

Address: 0x010

Type: R/W

Reset: 0x60

Description:

[6]	system__gpio0_is_xshutdown: Priority mode - when enabled, other bits of the register are ignored. GPIO0 is main XSHUTDOWN input. 0: Disabled 1: Enabled - GPIO0 is main XSHUTDOWN input.
[5]	system__gpio0_polarity: Signal Polarity Selection. 0: Active-low 1: Active-high
[4:1]	system__gpio0_select: Functional configuration options. 0000: OFF (Hi-Z) 1000: GPIO Interrupt output
[0]	Reserved. Write 0.

6.2.10 SYSTEM__MODE_GPIO1

7	6	5	4	3	2	1	0
RESERVED		system__gpio1_polarity	system__gpio1_select				RESERVED
R		R/W	R/W				R/W

Address: 0x011

Type: R/W

Reset: 0x20

Description:

[5]	system__gpio1_polarity: Signal Polarity Selection. 0: Active-low 1: Active-high
[4:1]	system__gpio1_select: Functional configuration options. 0000: OFF (Hi-Z) 1000: GPIO Interrupt output
[0]	Reserved. Write 0.

6.2.11 SYSTEM__HISTORY_CTRL

7	6	5	4	3	2	1	0
RESERVED					system__history_buffer_clear	system__history_buffer_mode	system__history_buffer_enable
R					R/W	R/W	R/W

Address: 0x012

Type: R/W

Reset: 0x0

Description:

[2]	system__history_buffer_clear: User-command to clear history (FW will auto-clear this bit when clear has completed). 0: Disabled 1: Clear all history buffers
[1]	system__history_buffer_mode: Select mode buffer results for: 0: Ranging (stores the last 8 ranging values (8-bit)) 1: ALS (stores the last 8 ALS values (16-bit))
[0]	system__history_buffer_enable: Enable History buffering. 0: Disabled 1: Enabled

6.2.12 SYSTEM_INTERRUPT_CONFIG_GPIO

7	6	5	4	3	2	1	0
RESERVED		als_int_mode			range_int_mode		
R		R/W			R/W		

Address: 0x014

Type: R/W

Reset: 0x0

Description:

[5:3]	als_int_mode: Interrupt mode source for ALS readings: 0: Disabled 1: Level Low (value < thresh_low) 2: Level High (value > thresh_high) 3: Out Of Window (value < thresh_low OR value > thresh_high) 4: New sample ready
[2:0]	range_int_mode: Interrupt mode source for Range readings: 0: Disabled 1: Level Low (value < thresh_low) 2: Level High (value > thresh_high) 3: Out Of Window (value < thresh_low OR value > thresh_high) 4: New sample ready

6.2.13 SYSTEM_INTERRUPT_CLEAR

7	6	5	4	3	2	1	0
RESERVED					int_clear_sig		
R					R/W		

Address: 0x015

Type: R/W

Reset: 0x0

Description:

[2:0]	int_clear_sig: Interrupt clear bits. Writing a 1 to each bit will clear the intended interrupt. Bit [0] - Clear Range Int Bit [1] - Clear ALS Int Bit [2] - Clear Error Int.
-------	---

6.2.14 SYSTEM_FRESH_OUT_OF_RESET

7	6	5	4	3	2	1	0
RESERVED							fresh_out_of_reset
R							R/W

Address: 0x016

Type: R/W

Reset: 0x1

Description:

[0]	fresh_out_of_reset: Fresh out of reset bit, default of 1, user can set this to 0 after initial boot and can therefore use this to check for a reset condition
-----	---

6.2.15 SYSTEM_GROUPED_PARAMETER_HOLD

7	6	5	4	3	2	1	0
RESERVED							grouped_parameter_hold
R							R/W

Address: 0x017

Type: R/W

Reset: 0x0

Description:

[0]	<p>grouped_parameter_hold: Flag set over I²C to indicate that data is being updated</p> <p>0: Data is stable - FW is safe to copy</p> <p>1: Data being updated - FW not safe to copy</p> <p>Usage: set to 0x01 first, write any of the registers listed below, then set to 0x00 so that the settings are used by the firmware at the start of the next measurement.</p> <p>SYSTEM_INTERRUPT_CONFIG_GPIO</p> <p>SYSRANGE_THRESH_HIGH</p> <p>SYSRANGE_THRESH_LOW</p> <p>SYSALS_INTEGRATION_PERIOD</p> <p>SYSALS_ANALOGUE_GAIN</p> <p>SYSALS_THRESH_HIGH</p> <p>SYSALS_THRESH_LOW</p>
-----	---

6.2.16 SYSRANGE__START

7	6	5	4	3	2	1	0
RESERVED						sysrange__mode_select	sysrange__startstop
R						R/W	R/W

Address: 0x018

Type: R/W

Reset: 0x0

Description:

[1]	sysrange__mode_select: Device Mode select 0: Ranging Mode Single-Shot 1: Ranging Mode Continuous
[0]	sysrange__startstop: StartStop trigger based on current mode and system configuration of device_ready. FW clears register automatically. Setting this bit to 1 in single-shot mode starts a single measurement. Setting this bit to 1 in continuous mode will either start continuous operation (if stopped) or halt continuous operation (if started). This bit is auto-cleared in both modes of operation.

6.2.17 SYSRANGE__THRESH_HIGH

7	6	5	4	3	2	1	0
sysrange__thresh_high							
R/W							

Address: 0x019

Type: R/W

Reset: 0xFF

Description:

[7:0]	sysrange__thresh_high: High Threshold value for ranging comparison. Range 0-255mm.
-------	--

6.2.18 SYSRANGE__THRESH_LOW

7	6	5	4	3	2	1	0
sysrange__thresh_low							
R/W							

Address: 0x01A

Type: R/W

Reset: 0x0

Description:

[7:0]	sysrange__thresh_low: Low Threshold value for ranging comparison. Range 0-255mm.
-------	--

6.2.19 SYSRANGE__INTERMEASUREMENT_PERIOD

7	6	5	4	3	2	1	0
sysrange__intermeasurement_period							
R/W							

Address: 0x01B

Type: R/W

Reset: 0xFF

Description:

[7:0]	sysrange__intermeasurement_period: Time delay between measurements in Ranging continuous mode. Range 0-254 (0 = 10ms). Step size = 10ms.
-------	--

6.2.20 SYSRANGE__MAX_CONVERGENCE_TIME

7	6	5	4	3	2	1	0
RESERVED		sysrange__max_convergence_time					
R		R/W					

Address: 0x01C

Type: R/W

Reset: 0x31

Description:

[5:0]	sysrange__max_convergence_time: Maximum time to run measurement in Ranging modes. Range 1 - 63 ms (1 code = 1 ms); Measurement aborted when limit reached to aid power reduction. For example, 0x01 = 1ms, 0x0a = 10ms. Note: Effective max_convergence_time depends on readout_averaging_sample_period setting.
-------	---

6.2.21 SYSRANGE__CROSSTALK_COMPENSATION_RATE

15	14	13	12	11	10	9	8	7	6	5	4	3	2	1	0
sysrange__crosstalk_compensation_rate															
R/W															

Address: 0x01E**Type:** R/W**Reset:** 0x0**Description:**

[15:0]	sysrange__crosstalk_compensation_rate: User-controlled crosstalk compensation in Mcps (9.7 format).
--------	---

6.2.22 SYSRANGE__CROSSTALK_VALID_HEIGHT

7	6	5	4	3	2	1	0
sysrange__crosstalk_valid_height							
R/W							

Address: 0x021**Type:** R/W**Reset:** 0x14**Description:**

[7:0]	sysrange__crosstalk_valid_height: Minimum range value in mm to qualify for crosstalk compensation.
-------	--

6.2.23 SYSRANGE__EARLY_CONVERGENCE_ESTIMATE

15	14	13	12	11	10	9	8	7	6	5	4	3	2	1	0
sysrange__early_convergence_estimate															
R/W															

Address: 0x022**Type:** R/W**Reset:** 0x0**Description:**

[15:0]	FW carries out an estimate of convergence rate 0.5ms into each new range measurement. If convergence rate is below user input value, the operation aborts to save power. Note: This register must be configured otherwise ECE should be disabled via SYSRANGE__RANGE_CHECK_ENABLES.
--------	--

6.2.24 SYSRANGE__PART_TO_PART_RANGE_OFFSET

7	6	5	4	3	2	1	0
sysrange__part_to_part_range_offset							
R/W							

Address: 0x024
Type: R/W
Reset: 0xYY, register default overwritten at boot-up by NVM contents.

Description:

[7:0]	sysrange__part_to_part_range_offset: 2s complement format.
-------	--

6.2.25 SYSRANGE__RANGE_IGNORE_VALID_HEIGHT

7	6	5	4	3	2	1	0
sysrange__range_ignore_valid_height							
R/W							

Address: 0x025
Type: R/W
Reset: 0x0, register default overwritten at boot-up by NVM contents.

Description:

[7:0]	sysrange__range_ignore_valid_height: Range below which ignore threshold is applied. Aim is to ignore the cover glass i.e. low signal rate at near distance. Should not be applied to low reflectance target at far distance. Range in mm. Note: It is recommended to set this register to 255 if the range ignore feature is used.
-------	---

6.2.26 SYSRANGE__RANGE_IGNORE_THRESHOLD

15	14	13	12	11	10	9	8	7	6	5	4	3	2	1	0
sysrange__range_ignore_threshold															
R/W															

Address: 0x026
Type: R/W
Reset: 0xYY

Description:

[15:0]	sysrange__range_ignore_threshold: User configurable min threshold signal return rate. Used to filter out ranging due to cover glass when there is no target above the device. Mcps 9.7 format. Note: Register must be initialized if this feature is used.
--------	---

6.2.27 SYSRANGE__MAX_AMBIENT_LEVEL_MULT

7	6	5	4	3	2	1	0
sysrange__max_ambient_level_mult							
R/W							

Address: 0x02C

Type: R/W

Reset: 0xA0, register default overwritten at boot-up by NVM contents.

Description:

[7:0]	sysrange__max_ambient_level_mult: User input value to multiply return_signal_count for AMB:signal ratio check. If (amb counts * 6) > return_signal_count * mult then abandon measurement due to high ambient (4.4 format).
-------	--

6.2.28 SYSRANGE__RANGE_CHECK_ENABLES

7	6	5	4	3	2	1	0
RESERVED			sysrange__signal_to_noise_enable	0	0	sysrange__range_ignore_enable	sysrange__early_convergence_enable
R			R/W	R/W	R	R/W	R/W

Address: 0x02D

Type: R/W

Reset: 0x11, register default overwritten at boot-up by NVM contents.

Description:

[4]	sysrange__signal_to_noise_enable: Measurement enable/disable
[1]	sysrange__range_ignore_enable: Measurement enable/disable
[0]	sysrange__early_convergence_enable: Measurement enable/disable

6.2.29 SYSRANGE__VHV_RECALIBRATE

7	6	5	4	3	2	1	0
RESERVED						sysrange__vhw_status	sysrange__vhw_recalibrate
R						R/W	R/W

Address: 0x02E

Type: R/W

Reset: 0x0

Description:

[1]	sysrange__vhw_status: FW controlled status bit showing when FW has completed auto-vhw process. 0: FW has finished autoVHV operation 1: During autoVHV operation
[0]	sysrange__vhw_recalibrate: User-Controlled enable bit to force FW to carry out recalibration of the VHV setting for sensor array. FW clears bit after operation carried out. 0: Disabled 1: Manual trigger for VHV recalibration. Can only be called when ALS and ranging are in STOP mode

6.2.30 SYSRANGE__VHV_REPEAT_RATE

7	6	5	4	3	2	1	0
sysrange__vhw_repeate_rate							
R/W							

Address: 0x031

Type: R/W

Reset: 0x0

Description:

[7:0]	sysrange__vhw_repeat_rate: User entered repeat rate of auto VHV task (0 = off, 255 = after every 255 measurements)
-------	--

6.2.31 SYSALS__START

7	6	5	4	3	2	1	0
RESERVED						sysals__mode_select	sysals__startstop
R						R/W	R/W

Address: 0x038

Type: R/W

Reset: 0x0

Description:

[1]	sysals__mode_select: Device Mode select 0: ALS Mode Single-Shot 1: ALS Mode Continuous
[0]	sysals__startstop: Start/Stop trigger based on current mode and system configuration of device_ready. FW clears register automatically. Setting this bit to 1 in single-shot mode starts a single measurement. Setting this bit to 1 in continuous mode will either start continuous operation (if stopped) or halt continuous operation (if started). This bit is auto-cleared in both modes of operation. See 6.2.56: INTERLEAVED_MODE__ENABLE for combined ALS and Range operation.

6.2.32 SYSALS__THRESH_HIGH

15	14	13	12	11	10	9	8	7	6	5	4	3	2	1	0
sysals__thresh_high															
R/W															

Address: 0x03A

Type: R/W

Reset: 0xFFFF

Description:

[15:0]	sysals__thresh_high: High Threshold value for ALS comparison. Range 0-65535 codes.
--------	--

6.2.33 SYSALS__THRESH_LOW

15	14	13	12	11	10	9	8	7	6	5	4	3	2	1	0
sysals__thresh_low															
R/W															

Address: 0x03C

Type: R/W

Reset: 0x0

Description:

[15:0]	sysals__thresh_low: Low Threshold value for ALS comparison. Range 0-65535 codes.
--------	--

6.2.34 SYSALS__INTERMEASUREMENT_PERIOD

7	6	5	4	3	2	1	0
sysals__intermeasurement_period							
R/W							

Address: 0x03E

Type: R/W

Reset: 0xFF

Description:

[7:0]	sysals__intermeasurement_period: Time delay between measurements in ALS continuous mode. Range 0-254 (0 = 10ms). Step size = 10ms.
-------	--

6.2.35 SYSALS__ANALOGUE_GAIN

7	6	5	4	3	2	1	0
RESERVED					sysals__analogue_gain_light		
R					R/W		

Address: 0x03F**Type:** R/W**Reset:** 0x06**Description:**

[2:0]	sysals__analogue_gain_light: ALS analogue gain (light channel) 0: ALS Gain = 20 1: ALS Gain = 10 2: ALS Gain = 5.0 3: ALS Gain = 2.5 4: ALS Gain = 1.67 5: ALS Gain = 1.25 6: ALS Gain = 1.0 7: ALS Gain = 40 Controls the "light" channel gain. Note: Upper nibble should be set to 0x4 i.e. For ALS gain of 1.0 write 0x46.
-------	---

6.2.36 SYSALS__INTEGRATION_PERIOD

15	14	13	12	11	10	9	8	7	6	5	4	3	2	1	0
RESERVED								sysals__integration_period							
R								R/W							

Address: 0x040**Type:** R/W**Reset:** 0x0**Description:**

[8:0]	sysals__integration_period: Integration period for ALS mode. 1 code = 1 ms (0 = 1 ms). Recommended setting is 100 ms (0x63).
-------	---

6.2.37 RESULT__RANGE_STATUS

7	6	5	4	3	2	1	0
result__range_error_code				result__range_min_threshold_hit	result__range_max_threshold_hit	result__range_measurement_ready	result__range_device_ready
R				R	R	R	R

Address: 0x04D

Type: R

Reset: 0x1

Description:

[7:4]	result__range_error_code: Specific error codes 0000: No error 0001: VCSEL Continuity Test 0010: VCSEL Watchdog Test 0011: VCSEL Watchdog 0100: PLL1 Lock 0101: PLL2 Lock 0110: Early Convergence Estimate 0111: Max Convergence 1000: No Target Ignore 1001: Not used 1010: Not used 1011: Max Signal To Noise Ratio 1100: Raw Ranging Algo Underflow 1101: Raw Ranging Algo Overflow 1110: Ranging Algo Underflow 1111: Ranging Algo Overflow
[3]	result__range_min_threshold_hit: Legacy register - DO NOT USE Use instead 6.2.39: RESULT__INTERRUPT_STATUS_GPIO
[2]	result__range_max_threshold_hit: Legacy register - DO NOT USE Use instead 6.2.39: RESULT__INTERRUPT_STATUS_GPIO
[1]	result__range_measurement_ready: Legacy register - DO NOT USE Use instead 6.2.39: RESULT__INTERRUPT_STATUS_GPIO
[0]	result__range_device_ready: Device Ready. When set to 1, indicates the device mode and configuration can be changed and a new start command will be accepted. When 0, indicates the device is busy.

6.2.38 RESULT__ALS_STATUS

7	6	5	4	3	2	1	0
result__als_error_code				result__als_min_threshold_hit	result__als_max_threshold_hit	result__als_measurement_ready	result__als_device_ready
R				R	R	R	R

Address: 0x04E

Type: R

Reset: 0x1

Description:

[7:4]	result__als_error_code: Specific error and debug codes 0000: No error 0001: Overflow error 0002: Underflow error
[3]	result__als_min_threshold_hit: Legacy register - DO NOT USE Use instead 6.2.39: RESULT__INTERRUPT_STATUS_GPIO
[2]	result__als_max_threshold_hit: Legacy register - DO NOT USE Use instead 6.2.39: RESULT__INTERRUPT_STATUS_GPIO
[1]	result__als_measurement_ready: Legacy register - DO NOT USE Use instead 6.2.39: RESULT__INTERRUPT_STATUS_GPIO
[0]	result__als_device_ready: Device Ready. When set to 1, indicates the device mode and configuration can be changed and a new start command will be accepted. When 0 indicates the device is busy.

6.2.39 RESULT_INTERRUPT_STATUS_GPIO

7	6	5	4	3	2	1	0
result_int_error_gpio		result_int_als_gpio			result_int_range_gpio		
R		R			R		

Address: 0x04F

Type: R

Reset: 0x0

Description:

[7:6]	result_int_error_gpio: Interrupt bits for Error: 0: No error reported 1: Laser Safety Error 2: PLL error (either PLL1 or PLL2)
[5:3]	result_int_als_gpio: Interrupt bits for ALS: 0: No threshold events reported 1: Level Low threshold event 2: Level High threshold event 3: Out Of Window threshold event 4: New Sample Ready threshold event
[2:0]	result_int_range_gpio: Interrupt bits for Range: 0: No threshold events reported 1: Level Low threshold event 2: Level High threshold event 3: Out Of Window threshold event 4: New Sample Ready threshold event

6.2.40 RESULT_ALS_VAL

15	14	13	12	11	10	9	8	7	6	5	4	3	2	1	0
result_als_ambient_light															
R															

Address: 0x050

Type: R

Reset: 0x0

Description:

[15:0]	result_als_ambient_light: 16 Bit ALS count output value. Lux value depends on Gain and integration settings and calibrated lux/count setting.
--------	---

6.2.41 RESULT__HISTORY_BUFFER_x

	15	14	13	12	11	10	9	8	7	6	5	4	3	2	1	0
RESULT__HISTORY_BUFFER_0	result__history_buffer_0															
RESULT__HISTORY_BUFFER_1	result__history_buffer_1															
RESULT__HISTORY_BUFFER_2	result__history_buffer_2															
RESULT__HISTORY_BUFFER_3	result__history_buffer_3															
RESULT__HISTORY_BUFFER_4	result__history_buffer_4															
RESULT__HISTORY_BUFFER_5	result__history_buffer_5															
RESULT__HISTORY_BUFFER_6	result__history_buffer_6															
RESULT__HISTORY_BUFFER_7	result__history_buffer_7															
	R															

Address: 0x052 + x * 0x2 (x=0 to 7)

Type: R

Reset: 0x0

Description: See also [6.2.11: SYSTEM__HISTORY_CTRL](#)

RESULT__HISTORY_BUFFER_0: [15:0]	result__history_buffer_0: Range/ALS result value. Range mode; Bits[15:8] range_val_latest; Bits[7:0] range_val_d1; ALS mode; Bits[15:0] als_val_latest
RESULT__HISTORY_BUFFER_1: [15:0]	result__history_buffer_1: Range/ALS result value. Range mode; Bits[15:8] range_val_d2; Bits[7:0] range_val_d3; ALS mode; Bits[15:0] als_val_d1
RESULT__HISTORY_BUFFER_2: [15:0]	result__history_buffer_2: Range/ALS result value. Range mode; Bits[15:8] range_val_d4; Bits[7:0] range_val_d5; ALS mode; Bits[15:0] als_val_d2
RESULT__HISTORY_BUFFER_3: [15:0]	result__history_buffer_3: Range/ALS result value. Range mode; Bits[15:8] range_val_d6; Bits[7:0] range_val_d7; ALS mode; Bits[15:0] als_val_d3
RESULT__HISTORY_BUFFER_4: [15:0]	result__history_buffer_4: Range/ALS result value. Range mode; Bits[15:8] range_val_d8; Bits[7:0] range_val_d9; ALS mode; Bits[15:0] als_val_d4
RESULT__HISTORY_BUFFER_5: [15:0]	result__history_buffer_5: Range/ALS result value. Range mode; Bits[15:8] range_val_d10; Bits[7:0] range_val_d11; ALS mode; Bits[15:0] als_val_d5
RESULT__HISTORY_BUFFER_6: [15:0]	result__history_buffer_6: Range/ALS result value. Range mode; Bits[15:8] range_val_d12; Bits[7:0] range_val_d13; ALS mode; Bits[15:0] als_val_d6
RESULT__HISTORY_BUFFER_7: [15:0]	result__history_buffer_7: Range/ALS result value. Range mode; Bits[15:8] range_val_d14; Bits[7:0] range_val_d15; ALS mode; Bits[15:0] als_val_d7

6.2.42 RESULT__RANGE_VAL

7	6	5	4	3	2	1	0
result__range_val							
R							

Address: 0x062

Type: R

Reset: 0x0

Description:

[7:0]	result__range_val: Final range result value presented to the user for use. Unit is in mm.
-------	---

6.2.43 RESULT__RANGE_RAW

7	6	5	4	3	2	1	0
result__range_raw							
R							

Address: 0x064

Type: R

Reset: 0x0

Description:

[7:0]	result__range_raw: Raw Range result value with offset applied (no cross talk compensation applied). Unit is in mm.
-------	--

6.2.44 RESULT__RANGE_RETURN_RATE

15	14	13	12	11	10	9	8	7	6	5	4	3	2	1	0
result__range_return_rate															
R															

Address: 0x066

Type: R

Reset: 0x0

Description:

[15:0]	result__range_return_rate: sensor count rate of signal returns correlated to IR emitter. Computed from RETURN_SIGNAL_COUNT / RETURN_CONV_TIME. Mcps 9.7 format
--------	--

6.2.45 RESULT__RANGE_REFERENCE_RATE

15	14	13	12	11	10	9	8	7	6	5	4	3	2	1	0
result__range_reference_rate															
R															

Address: 0x068

Type: R

Reset: 0x0

Description:

[15:0]	result__range_reference_rate: sensor count rate of reference signal returns. Computed from REFERENCE_SIGNAL_COUNT / RETURN_CONV_TIME. Mcps 9.7 format Note: Both arrays converge at the same time, so using the return array convergence time is correct.
--------	--

6.2.46 RESULT__RANGE_RETURN_SIGNAL_COUNT

31	30	29	28	27	26	25	24	23	22	21	20	19	18	17	16	15	14	13	12	11	10	9	8	7	6	5	4	3	2	1	0		
result__range_return_signal_count																																	
R																																	

Address: 0x06C

Type: R

Reset: 0x0

Description:

[31:0]	result__range_return_signal_count: sensor count output value attributed to signal correlated to IR emitter on the Return array.
--------	---

6.2.47 RESULT__RANGE_REFERENCE_SIGNAL_COUNT

31	30	29	28	27	26	25	24	23	22	21	20	19	18	17	16	15	14	13	12	11	10	9	8	7	6	5	4	3	2	1	0
result__range_reference_signal_count																															
R																															

Address: 0x070

Type: R

Reset: 0x0

Description:

[31:0]	result__range_reference_signal_count: sensor count output value attributed to signal correlated to IR emitter on the Reference array.
--------	---

6.2.48 RESULT__RANGE_RETURN_AMB_COUNT

31	30	29	28	27	26	25	24	23	22	21	20	19	18	17	16	15	14	13	12	11	10	9	8	7	6	5	4	3	2	1	0
result__range_return_amb_count																															
R																															

Address: 0x074

Type: R

Reset: 0x0

Description:

[31:0]	result__range_return_amb_count: sensor count output value attributed to uncorrelated ambient signal on the Return array. Must be multiplied by 6 if used to calculate the ambient to signal threshold.
--------	--

6.2.49 RESULT__RANGE_REFERENCE_AMB_COUNT

31	30	29	28	27	26	25	24	23	22	21	20	19	18	17	16	15	14	13	12	11	10	9	8	7	6	5	4	3	2	1	0
result__range_reference_amb_count																															
R																															

Address: 0x078

Type: R

Reset: 0x0

Description:

[31:0]	result__range_reference_amb_count: sensor count output value attributed to uncorrelated ambient signal on the Reference array.
--------	--

6.2.50 RESULT__RANGE_RETURN_CONV_TIME

31	30	29	28	27	26	25	24	23	22	21	20	19	18	17	16	15	14	13	12	11	10	9	8	7	6	5	4	3	2	1	0
result__range_return_conv_time																															
R																															

Address: 0x07C

Type: R

Reset: 0x0

Description:

[31:0]	result__range_return_conv_time: sensor count output value attributed to signal on the Return array.
--------	---

6.2.51 RESULT__RANGE_REFERENCE_CONV_TIME

31	30	29	28	27	26	25	24	23	22	21	20	19	18	17	16	15	14	13	12	11	10	9	8	7	6	5	4	3	2	1	0
result__range_reference_conv_time																															
R																															

Address: 0x080

Type: R

Reset: 0x0

Description:

[31:0]	result__range_reference_conv_time: sensor count output value attributed to signal on the Reference array.
--------	---

6.2.52 READOUT__AVERAGING_SAMPLE_PERIOD

7	6	5	4	3	2	1	0
readout__averaging_sample_period							
R/W							

Address: 0x10A

Type: R/W

Reset: 0x30

Description:

[7:0]	readout__averaging_sample_period: The internal readout averaging sample period can be adjusted from 0 to 255. Increasing the sampling period decreases noise but also reduces the effective max convergence time and increases power consumption: Effective max convergence time = max convergence time - readout averaging period (see Section 2.5: Range timing). Each unit sample period corresponds to around 64.5 μs additional processing time. The recommended setting is 48 which equates to around 4.3 ms.
-------	---

6.2.53 FIRMWARE__BOOTUP

7	6	5	4	3	2	1	0
RESERVED							firmware__bootup
R							R/W

Address: 0x119

Type: R/W

Reset: 0x1

Description:

[0]	firmware__bootup: FW must set bit once initial boot has been completed.
-----	---

6.2.54 FIRMWARE__RESULT_SCALER

7	6	5	4	3	2	1	0
RESERVED				firmware__als_result_scaler			
R				R/W			

Address: 0x120

Type: R/W

Reset: 0x1

Description:

[3:0]	firmware__als_result_scaler: Bits [3:0] analogue gain 1 to 16x
-------	--

6.2.55 I2C_SLAVE__DEVICE_ADDRESS

7	6	5	4	3	2	1	0
RESERVED	super_i2c_slave__device_address						
R	R/W						

Address: 0x212

Type: R/W

Reset: 0x29

Description:

[6:0]	super_i2c_slave__device_address: User programmable I ² C address (7-bit). Device address can be re-designated after power-up.
-------	--

6.2.56 INTERLEAVED_MODE_ENABLE

7	6	5	4	3	2	1	0
interleaved_mode_enable							
R/W							

Address: 0x2A3**Type:** R/W**Reset:** 0x0**Description:**

[7:0]	Interleaved mode enable: Write 0x1 to this register to select ALS+Range interleaved mode. Use SYSALS__START and SYSALS__INTERMEASUREMENT_PERIOD to control this mode. A range measurement is automatically performed immediately after each ALS measurement.
-------	--

7 Outline drawing

Figure 27. Outline drawing (page 1/2)

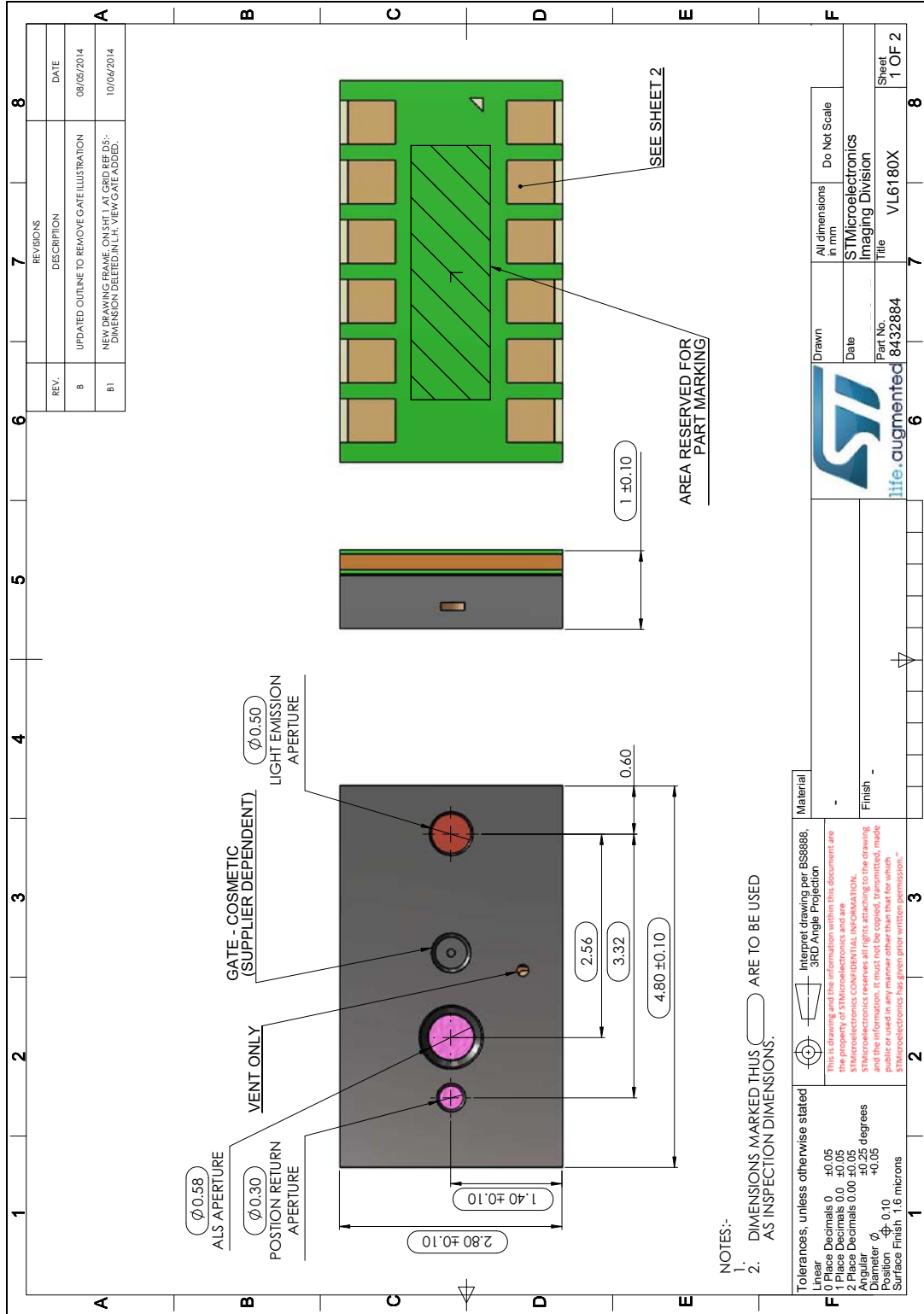

REV.	DESCRIPTION	DATE
B	UPDATED OUTLINE TO REMOVE GATE ILLUSTRATION	08/05/2014
B1	NEW DRAWING FRAMES ON SHEET 1 & 2. DIMENSIONS DELETED IN 1.1. NEW GATE ADDED. DIMENSION DELETED IN 1.1. NEW GATE ADDED.	10/04/2014

Material - Finish -		Material Interpret drawing per BS8888, 3RD Angle Projection This is drawing and the information within this document are the property of STMicroelectronics and are STMicroelectronics CONFIDENTIAL INFORMATION. STMicroelectronics reserves all rights attaching to the drawing and the information contained therein. No part of this drawing may be used in any manner other than that for which STMicroelectronics has given prior written permission.*	
Tolerances, unless otherwise stated Linear 0 Place Decimals 0 ± 0.05 1 Place Decimals 0.0 ± 0.05 2 Place Decimals 0.00 ± 0.05 Angles ± 0.25 degrees Position \varnothing 0.10 Surface Finish 1.6 microns		Drawn - Date - Part No. 8432884 Title VL6180X Sheet 1 OF 2	

- NOTES:-
1. DIMENSIONS MARKED THUS \varnothing ARE TO BE USED AS INSPECTION DIMENSIONS.



Figure 28. Outline drawing (page 2/2)

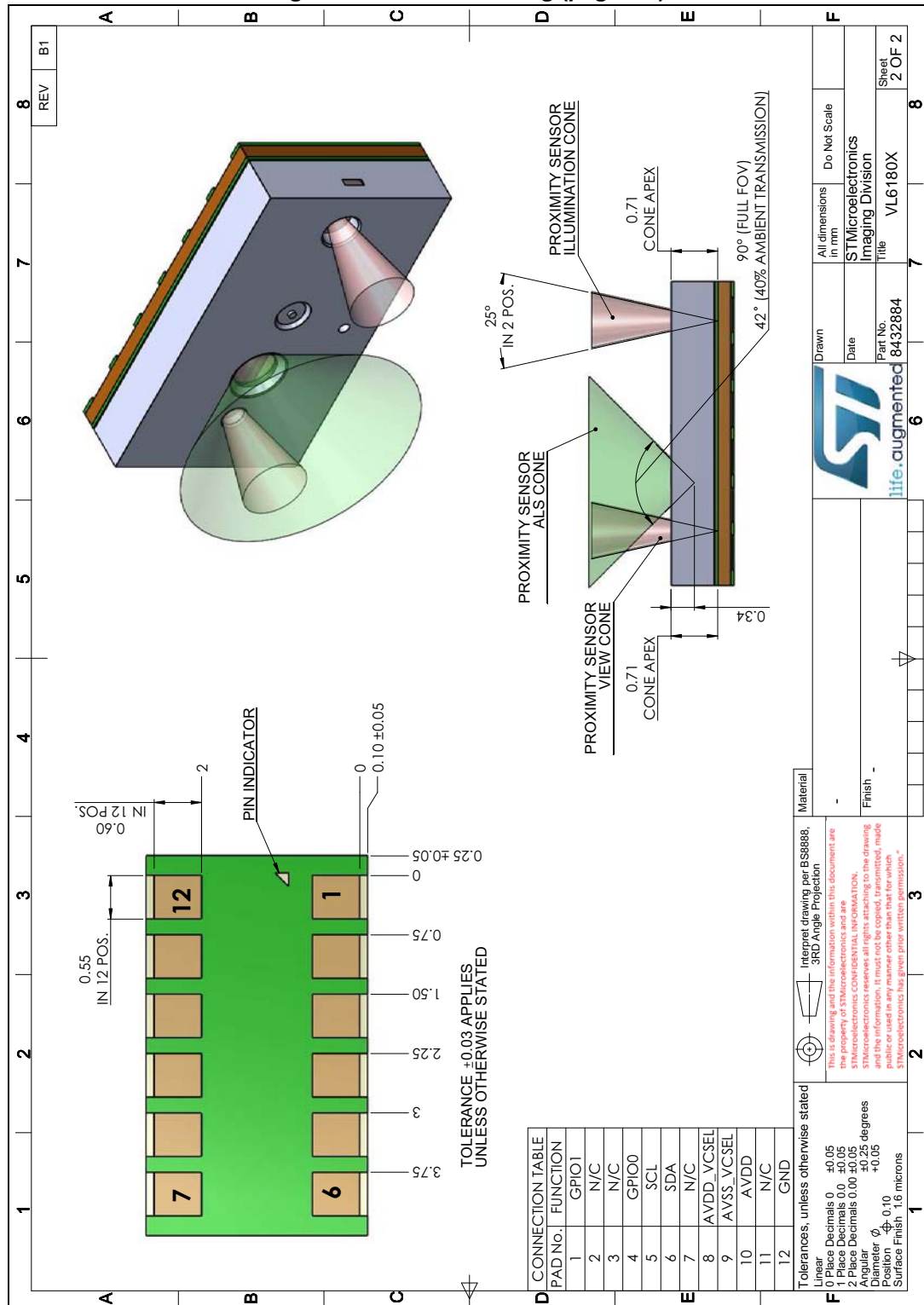

8 Laser safety considerations

The VL6180X contains a laser emitter and corresponding drive circuitry. The laser output is designed to remain within Class 1 laser safety limits under all reasonably foreseeable conditions including single faults in compliance with IEC 60825-1:2007. The laser output will remain within Class 1 limits as long as the STMicroelectronics recommended device settings are used and the operating conditions specified in this datasheet are respected. The laser output power must not be increased by any means and no optics should be used with the intention of focusing the laser beam.

Figure 29. Class 1 laser product label



8.1 Compliance

Complies with 21 CFR 1040.10 and 1040.11 except for deviations pursuant to Laser Notice No.50, dated June 24, 2007.

9 Ordering information

VL6180X is currently available in the following format. More detailed information is available on request.

Table 26. Delivery format

Order code	Description
VL6180XV0NR/1	Tape and reel (5000 units in a reel)

9.1 Traceability and identification

Latest ROM revision can be identified as follows:

0x002 IDENTIFICATION__MODEL_REV_MINOR = 3

The minimum information required for traceability is the content of the following registers:

0x006 - IDENTIFICATION__DATE_HI

0x007 - IDENTIFICATION__DATE_LO

0x008 - IDENTIFICATION__TIME (16-bit)

0x00A - IDENTIFICATION__CODE

With this information, the module can be uniquely identified.

Preferably, all the IDENTIFICATION register contents should be provided for traceability.

9.2 Part marking

Devices are marked on the underside as shown below. 1st line is the product ID. 2nd line is the manufacturing info. (circled in green), where the 1st four letters are the lot ID and the last 3 digits are the year + week number. Here: 338 is 2013 wk38. The final letter, circled in red, is the ROM revision ('D').

Figure 30. Part marking

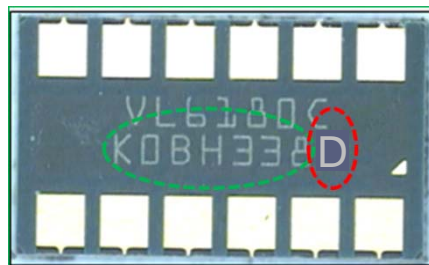

9.3 Packaging

The Root part number 1 is available in tape and reel packaging as shown in [Figure 31](#).

Figure 31. Tape and reel packaging

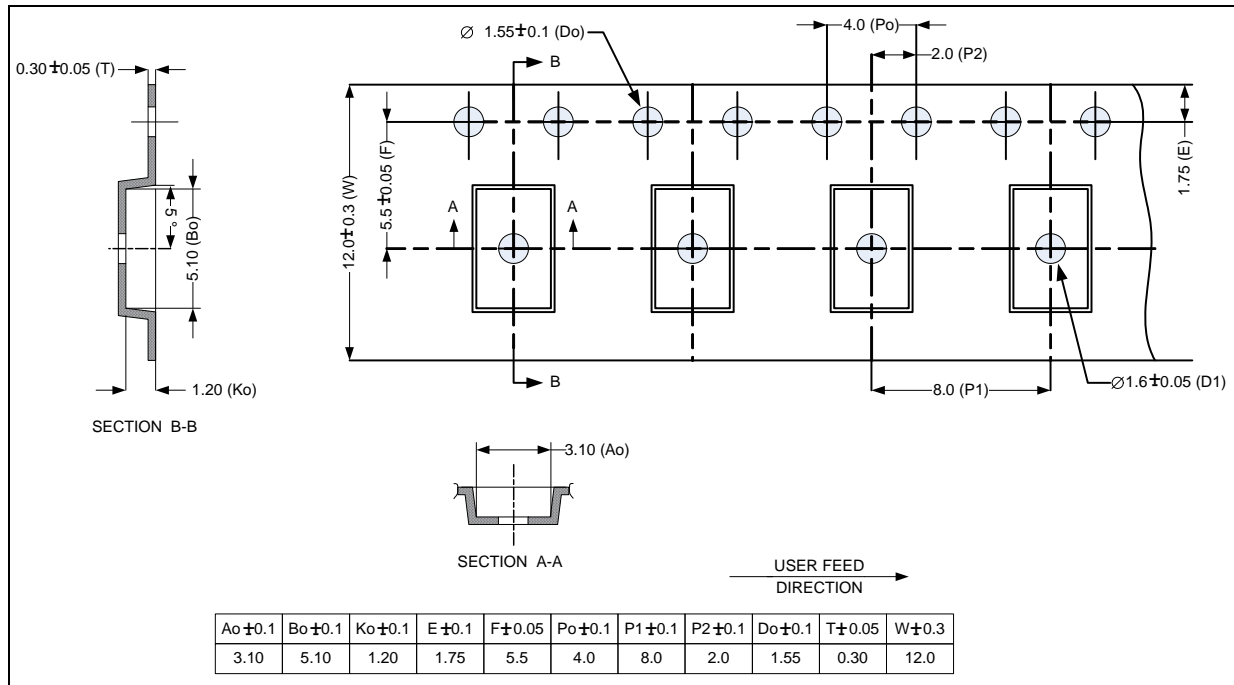

9.3.1 Package labeling

The labeling on the packing carton is shown in [Figure 32](#). The latest ROM revision is indicated alongside the order code (shaded green) and also after the product marking (shaded pink).

Figure 32. Package labeling

Manufactured under patents or patents pending

Assembled in: CHINA
 Pb-free 2nd Level Interconnect
 MSL: 3 Bag seal date: 08 MAR 2014
 PBT: 245 C Category: e4 ECOMPACT2/RoHS

STMicroelectronics

TYPE: ~~VL6180XV0NR/1~~
 VL6180XV0NR/168

Total Qty: 10
 Trace Code GK40706T UQ GK

Marking: VL6180CD
 Bulk ID: T4010PR50001

Please provide the bulk ID for any inquiry

9.4 Storage

The Root part number 1 is a MSL 3 package.

Table 27. Storage conditions

Level	Floor Life (out of bag) at Factory Ambient <30°C/60% RH
3	1 Week

After this limit, dry bake to be done; 3 hours at 125°C.

9.5 ROHS compliance

The Root part number 1 is Ecopack2 compliant as per ST definition.

Devices which are ROHS compliant even with use of ROHS exemption(s) and free of Halogenated flame retardant are named ECOPACK2 devices with the following definition:

- ROHS compliant even with use of ROHS exemption(s)
- 500 ppm maximum of Antimony as oxide or organic compound in each organic assy Materials (glue, substrate, mold compounds, housing...). Antimony in ceramic parts, in glass and in solder alloy is not restricted.
- 900 ppm maximum Bromine + Chlorine in each organic ass materials (glue, substrate, mold compounds, housing...)

These values are referring to maximum total content not to extractable ions content. Purchasing specification of assembly materials can impose lower values for technical reasons.

ECOPACK2 devices are of course fully compliant to ST banned and declarable substances specification and for example cannot contain red Phosphorus flame retardant.

10 ECOPACK®

In order to meet environmental requirements, ST offers these devices in different grades of ECOPACK® packages, depending on their level of environmental compliance. ECOPACK® specifications, grade definitions and product status are available at: www.st.com. ECOPACK® is an ST trademark.

11 Revision history

Table 28. Document revision history

Date	Revision	Changes
23-Sep-2013	1	Initial release.
30-Jan-2014	1.1	General update for latest ROM revision: <i>Section 1.1: Technical specification</i> updated <i>Section 1.4: Application schematic</i> updated <i>Section 1.5: Recommended solder pad dimensions</i> updated Notes added to <i>Figure 5.: Recommended reflow profile</i> <i>Section 2.13: Ambient light sensor (ALS)</i> updated. <i>Section 3.1: Absolute maximum ratings</i> added <i>Section 3.2: Normal operating conditions</i> extended <i>Section 4: Performance specification</i> added Revised outline drawing added to <i>Section 7: Outline drawing</i> Class 1 laser product label added to <i>Section 7: Outline drawing</i> <i>Section 9: Ordering information</i> added information relating to device marking and package labeling
02-Apr-2014	1.2	Updates to the following sections: <i>Section 1.5: Recommended solder pad dimensions</i> <i>Section 3.2: Normal operating conditions</i> <i>Section 3.4: Electrical characteristics</i> <i>Section 4.1: Proximity ranging (0 to 100mm)</i> Added <i>Section 4.2: ALS performance</i> Corrected error codes in <i>Section 6.2.38: RESULT__ALS_STATUS</i> Updated <i>Section 6.2.20: SYSRANGE__MAX_CONVERGENCE_TIME</i> Product code changed to VL6180X
09-Apr-14	2	Add documentation reference number (026171) Update Disclaimer
15-May-14	3	ALS linearity spec updated in <i>Section 4.2: ALS performance</i> Updated some detail in <i>Table 1.: Technical specification</i> Added comment to <i>Section 1.3: Device pinout</i> stating that pins labeled 'no connect' can optionally be connected to ground Added test condition to <i>Section 3.3: Current consumption</i> Errata corrections in <i>6.2.8</i> , <i>6.2.35</i> and <i>6.2.54</i> <i>Section 7: Outline drawing</i> updated (no dimensional changes) Dry bake conditions updated in <i>Section 9.4: Storage</i>
28-May-14	4	Added <i>Section 8.1: Compliance</i>

Table 28. Document revision history (continued)

Date	Revision	Changes
16-Jun-14	5	Re-write of <i>Section 2: Functional description</i> . <i>Section 6: Device registers</i> : Added introduction and minor corrections <i>Section 7: Outline drawing</i> updated to Rev B1. Supplier dependent gate mark added.
20-Aug-2014	6	Updates: <i>Section 2.8.3: Signal-to-noise ratio (SNR)</i> : Clarified SNR calculation. <i>Section 6: Device registers</i> : Corrected a clarified some register descriptions. Typical ranging performance graph updated. Delivery & manufacturing info updated.

IMPORTANT NOTICE – PLEASE READ CAREFULLY

STMicroelectronics NV and its subsidiaries ("ST") reserve the right to make changes, corrections, enhancements, modifications, and improvements to ST products and/or to this document at any time without notice. Purchasers should obtain the latest relevant information on ST products before placing orders. ST products are sold pursuant to ST's terms and conditions of sale in place at the time of order acknowledgement.

Purchasers are solely responsible for the choice, selection, and use of ST products and ST assumes no liability for application assistance or the design of Purchasers' products.

No license, express or implied, to any intellectual property right is granted by ST herein.

Resale of ST products with provisions different from the information set forth herein shall void any warranty granted by ST for such product.

ST and the ST logo are trademarks of ST. All other product or service names are the property of their respective owners.

Information in this document supersedes and replaces information previously supplied in any prior versions of this document.

© 2014 STMicroelectronics – All rights reserved

