

Features

- Ultra compact size (30.0 × 20.0mm)
- High RX sensitivity (-97dBm)
- Outperforming link budget (up to 100.6dB)
- Up to +3.6dBm output power
- Very low power consumption:
 - 9.6mA in RX mode ⁽¹⁾
 - 16.4mA in TX mode ⁽¹⁾
 - 0.6µA in sleep mode ⁽²⁾
- Ample memory resources (256K Bytes In-System, Self-Programmable Flash memory, 8K Bytes EEPROM, 32K Bytes SRAM)
- Wide range of interfaces (both analog and digital)
 - 4- wire SPI, TWI
 - ISP, JTAG
 - 2 Analog comparator Input
 - UART, USART
 - Timer, PWM
 - 4 ADC lines
 - External Clock Input, Internal Clock Output
 - Upto 31 lines configurable as GPIO
- Preassigned Atmel[®] MAC address that can be used on end product
- Capability to use MAC address into the internal EEPROM
- IEEE[®] 802.15.4 compliant Transceiver
- 2.4GHz ISM band
- Serial bootloader
- High Performance Low power AVR 8-bit Microcontroller
- Rapid design-in with built-in Chip Antenna
- RF Test point using MS-147 RF connector
- Small physical footprint and low profile for optimum fit in very small application boards
- Mesh networking capability
- Easy-to-use low cost development kit
- Single source of support for HW and SW
- Worldwide license-free operation

Note: 1. MCU is in active state with 3V Supply, CPU clock @ 16MHz, RX RPC enabled (for RX current), PHY_TX_PWR=0x0 (for TX current), All digital outputs pulled high.

Note: 2. Controller Sleep Mode – SLEEP_MODE_PWR_DOWN

Table of Contents

1. Introduction	3
1.1 Summary.....	3
1.2 Applications.....	3
1.3 Abbreviations and Acronyms	3
1.4 Related Documents.....	4
2. ZigBit Module Overview	6
2.1 Overview	6
3. Specifications	8
3.1 Electrical Characteristics.....	8
3.1.1 Absolute Maximum Ratings	8
3.1.2 Power Supply.....	8
3.1.3 RF Characteristics	9
3.1.4 Microcontroller Characteristics.....	10
3.1.5 Module Interfaces Characteristics.....	10
3.2 Physical/Environmental Characteristics and Outline	10
3.3 Pin Configuration.....	11
3.4 Antenna Orientation Recommendation	12
3.5 Mounting Information	12
3.6 Soldering Profile.....	15
3.7 Antenna Reference Designs	16
4. Schematics	16
4.1 Handling Instructions.....	17
4.2 General Recommendations	17
5. Persistence Memory	17
6. Ordering Information	19
7. Agency Certifications	20
7.1 United States (FCC).....	20
7.2 European Union (ETSI).....	20
7.3 Industry Canada (IC) Compliance statements	21
8. Revision History	22

1. Introduction

1.1 Summary

ATZB-S1-256-3-0-C ZigBit® is an ultra-compact and low-power 2.4GHz IEEE 802.15.4/ZigBee® OEM module from Atmel. Based on the innovative mixed-signal hardware platform from Atmel, this module uses the ATmega256RFR2 SoC with the AVR® 8-Bit Microcontroller and a high data rate transceiver for the 2.4GHz ISM band. The radio transceiver provides high data rates from 250kb/s up to 2Mb/s, frame handling, outstanding receiver sensitivity and high transmit output power enabling a very robust wireless communication. The module is designed for wireless sensing, monitoring, control, data acquisition applications, to name a few. This ZigBit module eliminates the need for costly and time-consuming RF development, and shortens time-to-market for wireless applications.

The module has an MS-147 RF connector that can be used as an RF test port. The built-in chip antenna is designed and tuned for the ZigBit design to enable quick integration of the ZigBit into any application.

1.2 Applications

The ZigBit module is compatible with robust IEEE 802.15.4/ZigBee stack that supports a self-healing, self-organizing mesh network, while optimizing network traffic and minimizing power consumption.

For detailed Software support information, please visit www.atmel.com/wireless

The applications include, but are not limited to:

- Building automation & monitoring
 - Lighting controls
 - Wireless smoke- and CO-detectors
 - Structural integrity monitoring
- HVAC monitoring & control
- Inventory management
- Environmental monitoring
- Security
- Water metering
- Industrial monitoring
 - Machinery condition and performance monitoring
 - Monitoring of plant system parameters such as temperature, pressure, flow, tank level, humidity, vibration, etc.
- Automated meter reading (AMR)

1.3 Abbreviations and Acronyms

ADC	Analog-to-Digital Converter
API	Application Programming Interface
DC	Direct Current
DTR	Data Terminal Ready
EEPROM	Electrically Erasable Programmable Read-Only Memory
ESD	Electrostatic Discharge
GPIO	General Purpose Input/Output
HAF	High Frequency

HVAC	Heating, Ventilating, and Air Conditioning
HW	Hardware
I ² C	Inter-Integrated Circuit
IEEE	Institute of Electrical and Electronics Engineers
IRQ	Interrupt Request
ISM	Industrial, Scientific and Medical radio band
JTAG	Digital interface for debugging of embedded device, also known as IEEE 1149.1 standard interface
MAC	Medium Access Control layer
MCU	Microcontroller Unit. In this document it also means the processor, which is the core of a ZigBit module
NRE	Network layer
OEM	Original Equipment Manufacturer
OTA	Over-The-Air upgrade
PA	Power Amplifier
PCB	Printed Circuit Board
PER	Package Error Ratio
RAM	Random Access Memory
RF	Radio Frequency
RTS/CTS	Request to Send/ Clear to Send
RX	Receiver
SMA	Surface Mount Assembly
SoC	System on Chip
SPI	Serial Peripheral Interface
SW	Software
TTM	Time-To-Market
TX	Transmitter
UART	Universal Asynchronous Receiver/Transmitter
USART	Universal Synchronous/Asynchronous Receiver/Transmitter
USB	Universal Serial Bus
ZigBee, ZigBee PRO	Wireless networking standards targeted at low-power applications
802.15.4	The IEEE 802.15.4-2003 standard applicable to low-rate wireless Personal Area Network

1.4 Related Documents

- [1] ATmegaA1RFR2 8-bit AVR Microcontroller with 2.4GHz Transceiver for ZigBee and IEEE 802.15.4
- [2] MS-147 Series Interface RF Connector with Switch, 3.9mm High, DC to 6GHz
http://www.hirose.co.jp/cataloge_hp/e35801505.pdf
- [3] IEEE Std 802.15.4-2003 IEEE Standard for Information technology - Part 15.4 Wireless Medium Access Control (MAC) and Physical Layer (PHY) Specifications for Low-Rate Wireless Personal Area Networks (LR-WPANs)

[4] ZigBee Specification. ZigBee Document 053474r17, October 19, 2007

2. ZigBit Module Overview

2.1 Overview

The ATZB-S1-256-3-0-C ZigBit is an ultra compact, low-power, high sensitivity IEEE 802.15.4/ZigBee OEM module. Based on a solid combination of the latest Atmel MCU Wireless hardware platform, 2.4GHz ISM band transceiver and Atmel Studio Wireless Composer - the ZigBit offers an unmatched combination of superior radio performance, ultra-low power consumption and exceptional ease of integration.

Figure 2-1. ATZB-S1-256-3-0-C Block Diagram.

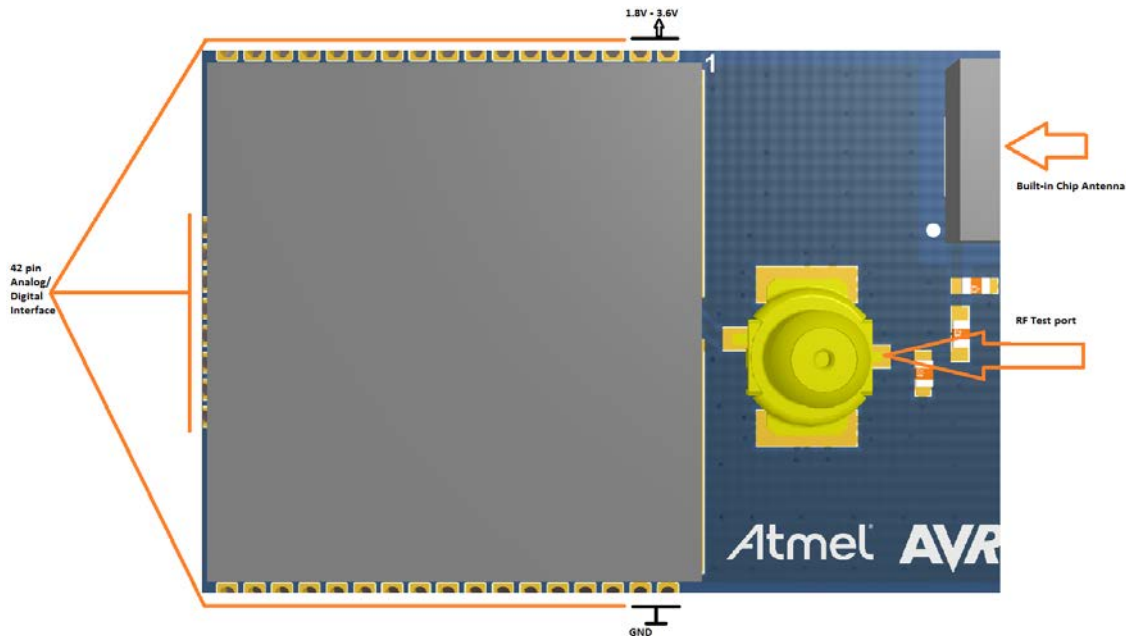

This ZigBit module contains the Atmel ATmega256RFR2 Microcontroller and a 2.4GHz ISM band Transceiver for ZigBee and IEEE 802.15.4 [1]. The module features 256KB In-System Self-Programmable flash memory, 32KB SRAM and 8KB EEPROM.

The compact all-in-one integration of MCU and Radio Transceiver inside the chip along with very minimal components on the RF path to Antenna dramatically improves the ZigBit's compact size, range performance on signal transmission and increases its sensitivity. This ensures stable connectivity within a larger coverage area, and helps develop applications on smaller footprint. The MS-147 connector [2] can be used as an RF Test port.

ZigBit Module contains a complete RF/MCU design with all the necessary passive components included. The module can be easily mounted on a simple 2-layer PCB with a minimum of required external connection. The ZigBit Module Evaluation kit containing the ZigBit Extension board for the Atmel Xplained PRO HW Evaluation platform can be used to develop FW using the Atmel Studio and evaluate using the Wireless Composer. Compared to a custom RF/MCU solution, a module-based solution offers considerable savings in development time and NRE cost per unit during the HW/FW design, prototyping, and mass production phases of product development.

All ZigBits are preloaded with a Bootloader when they are sold as Modules, either in Single units or T&R.

Depending on end-user design requirements, the ZigBit can operate as a self-contained sensor node, where it would function as a single MCU, or it can be paired with a host processor driving the module over a serial interface.

The MAC stack running on the host processor can then control data transmission and manages module peripherals. Thus very minimal firmware customization is required for a successful module design-in. Third-party sensors can then be connected directly to the module, thus expanding the existing set of peripheral interfaces.

Every ZigBit Module come pre loaded with Atmel assigned 64-bit MAC address stored in the signature bytes of the device. This unique IEEE MAC address can be used as the MAC address of the end product, so there is no need to buy a MAC address separately for the product using the ZigBit.

3. Specifications

3.1 Electrical Characteristics

3.1.1 Absolute Maximum Ratings

Table 3-1. Absolute maximum ratings ⁽¹⁾⁽²⁾.

Parameter	Minimum	Maximum
Voltage on any pin, except RESET with respect to ground	-0.3V	3.6V ($V_{DD\ max}$)
Input RF level		+14dBm
Voltage on any Analog configured pin	-0.3V	2.0V
Voltage on Aref (pin 24)	-0.3V	2.0V

Notes: 1. Absolute Maximum Ratings are the values beyond which damage to the device may occur. Under no circumstances must the absolute maximum ratings given in this table be violated. Stresses beyond those listed under "Absolute Maximum Ratings" may cause permanent damage to the device. This is a stress rating only. Functional operation of the device at these or other conditions, beyond those indicated in the operational sections of this specification, is not implied. Exposure to absolute maximum rating conditions for extended periods may affect device reliability.

- a) **Attention!** The ZigBit is an ESD-sensitive device. Precaution should be taken when handling the device in order to prevent permanent damage.

3.1.2 Power Supply

Table 3-2. Test conditions (unless otherwise stated), $F = 2.45\text{GHz}$, $V_{DD} = 3\text{V}$, $T_{amb} = 25^\circ\text{C}$.

Parameter	Range	Unit
Supply voltage, V_{DD}	1.8 to 3.6	V
Active Current consumption: RX mode - RX_ON – Listening state	17.0	mA
Active Current consumption: RX in RPC Mode	9.6	mA
Active Current consumption: TX mode ⁽¹⁾ – BUSY_TX – Transmit state	16.3	mA
Active Current consumption: TX mode – PLL_ON	9.9	mA
Active Current consumption: TRX_OFF	4.7	mA
Sleep Current consumption: Power-save mode ⁽²⁾	0.62	μA
Sleep Current consumption: Power-down mode ⁽²⁾	0.6	μA
Sleep Current consumption: Standby ⁽²⁾	2.4	mA
Sleep Current consumption: Idle ⁽²⁾	4.9	mA
Sleep Current consumption: Ext_Standby ⁽²⁾	0.9	mA

Note 1:

- a) Output TX power (when measuring consumption in TX mode) is +3 dBm.

Note 2:

- a) All interfaces are set to the default state (see Pin Assignment Table).
 b) JTAG is not connected.

- c) CPU Clock configured when doing this measurement – 16MHz for all modes except Power save and Power down modes

Current consumption depends on multiple factors, including but not limited to, the board design and materials, Protocol settings, network activity, EEPROM read/write operations. It also depends on MCU load and/or peripherals used by an application.

3.1.3 RF Characteristics

Table 3-3. RF characteristics.

Parameter	Condition	Typical Values	Unit
Frequency band		2.4000 to 2.4835	GHz
Numbers of channels		16	
Channel spacing		5	MHz
Transmitter output power	Adjusted in 16 steps	-16.5 to +3.5	dBm
Receiver sensitivity	PER = 1%	-97	dBm
On-air data rate		250, upto 2000	kbps
TX output/ RX input nominal impedance	Unbalanced	50	Ω
Range	Open field, LoS, Elevated	170 - 570 [#]	m

Note[#] Range measured is Line of Sight at 10ft elevation from Ground at different combinations of orientation of transmitter and receiver, with special conditions were there is minimal or no RF interference from other sources. For best case orientation of the ZigBits to achieve maximum range, refer to section 3.4.

Table 3-4. TX power settings

PHY_TX_PWR 3:0 Register value	Power register setting [dBm]	Typical Output power [dBm] (at RF connector)
0	+3.5	+3.79
1	+3.3	+3.40
2	+2.8	+3.41
3	+2.3	+2.43
4	+1.8	+2.41
5	+1.2	+1.21
6	+0.5	+0.58
7	-0.5	-0.11
8	-1.5	-1.02
9	-2.5	-1.97
10	-3.5	-3.12
11	-4.5	-4.48
12	-6.5	-6.28
13	-8.5	-8.52
14	-11.5	-11.64
15	-16.5	-16.26

3.1.4 Microcontroller Characteristics

Table 3-5. ATmega256RFR2 characteristics.

Parameters	Condition	Range	Unit
On-chip flash memory size		256K	Bytes
On-chip SRAM size		32K	Bytes
On-chip EEPROM size		8K	Bytes
Operation frequency		16	MHz

3.1.5 Module Interfaces Characteristics

Table 3-6. Module interfaces characteristics.

Parameters	Condition	Range	Unit
UART maximum baud rate		115.2	Kbps
ADC resolution conversion time	Free running conversion	3 - 240	μ s
ADC input resistance	Static load resistor of input signal	100	M Ω
ADC reference voltage (VREF)	AVDD=1.8V	1.5V to AVDD	V
ADC input voltage	AVDD=1.8V	0 - AVDD	V
TWI maximum clock		400	kHz
GPIO High level input voltage	Except nRST	Min 0.7 V _{DD}	V
GPIO Low level input voltage	Except nRST	Max 0.3 V _{DD}	V
GPIO High level input voltage	nRST	Min 0.9 V _{DD}	V
GPIO Low level input voltage	nRST	Max 0.1 V _{DD}	V
GPIO High level output voltage V _{OH}	I _{OH} = -12mA, V _{DD} = 3.6V I _{OH} = -6mA, V _{DD} = 1.8V	Min V _{DD} - 0.4	V
GPIO Low level output voltage V _{OL}	I _{OL} = 16mA, V _{DD} = 3.6V I _{OL} = 10mA, V _{DD} = 1.8V	Max 0.4	V
Real-time oscillator frequency		32.768	kHz

3.2 Physical/Environmental Characteristics and Outline

Table 3-7. Physical characteristics.

Parameters	Value	Comments
Size	30.0 x 20.0mm	
Operating temperature range	-40°C to +85°C	-40°C to +85°C operational

3.3 Pin Configuration

Table 3-8. ATZB-S1-256-3-0-C Pinout description

Pinout	Pin descriptions	Function
1	AVSS	Analog Ground
2	AVSS	Analog Ground
3	DEVDD	Digital Power input pin
4	DEVDD	Digital Power input pin
5	RSTN	RESET
6	PB0/SSN/PCINT0	SPI
7	PB2/MOSI/PDI/PCINT2	SPI/ ISP Prog
8	PB3/MISO/PDO/PCINT3	SPI/ ISP Prog
9	PB1/SCK/PCINT1	SPI/ ISP Prog
10	PE2/AINO	GPIO/AINO
11	PE3/AIN1/OC3A	GPIO/AIN1/PWM out
12	DVSS	Digital Ground
13	PD2/RXD1/INT2	UART
14	PD3/TXD1/INT3	UART
15	PD5/XCK1	USART
16	PD4/ICP1	TIMER counter input trigger
17	PD6/T1	TC
18	PG2/AMR	GPIO/TC
19	PB4/OC2A/PCINT4	PWM/PCINT4
20	PB6/OC1B/PCINT6	PWM/PCINT6
21	PB7/OC0A/OC1C/PCINT7	PWM/PCINT/GPIO
22	PE0:RXD0:PCINT8	GPIO/PCINT8/RXD0
23	PE1:TXD0	GPIO/TXD0
24	AREF	Adc ref
25	PF0/ADC0	ADC/ GPIO
26	PF1/ADC1	ADC/ GPIO
27	PF2/ADC2/DIG2	ADC/ GPIO
28	PF3/ADC3/DIG4	ADC/ GPIO
29	DVSS	Digital Ground
30	PF4/ADC4/TCK	JTAG
31	PF5/ADC5/TMS	JTAG
32	PF6/ADC6/TDO	JTAG
33	PF7/ADC7/TDI	JTAG
34	PG5/OC0B	pwm output timer
35	PE4/OC3B/INT4	Wakeup INT
36	PD0/SCL/INT0	TWI/INT/GPIO
37	PD1/SDA/INT1	TWI/INT/GPIO

Pinout	Pin descriptions	Function
38	CLKI	Ext CLKI/ ISP Programming
39	PE7/ICP3/INT7/CLKO	Clock out put
40	PD7/T0	TC
41	DVSS	Digital Ground
42	DVSS	Digital Ground

NOTE: TXD, RXD of UART are crossed inside ZigBit Module. External UART devices connecting to ZigBit Module should follow straight connection for UART:
 UART_TXD_external_device <-> UART_TXD
 UART_RXD_external_device <-> UART_RXD

3.4 Antenna Orientation Recommendation

Direction of best case Line of Sight Range

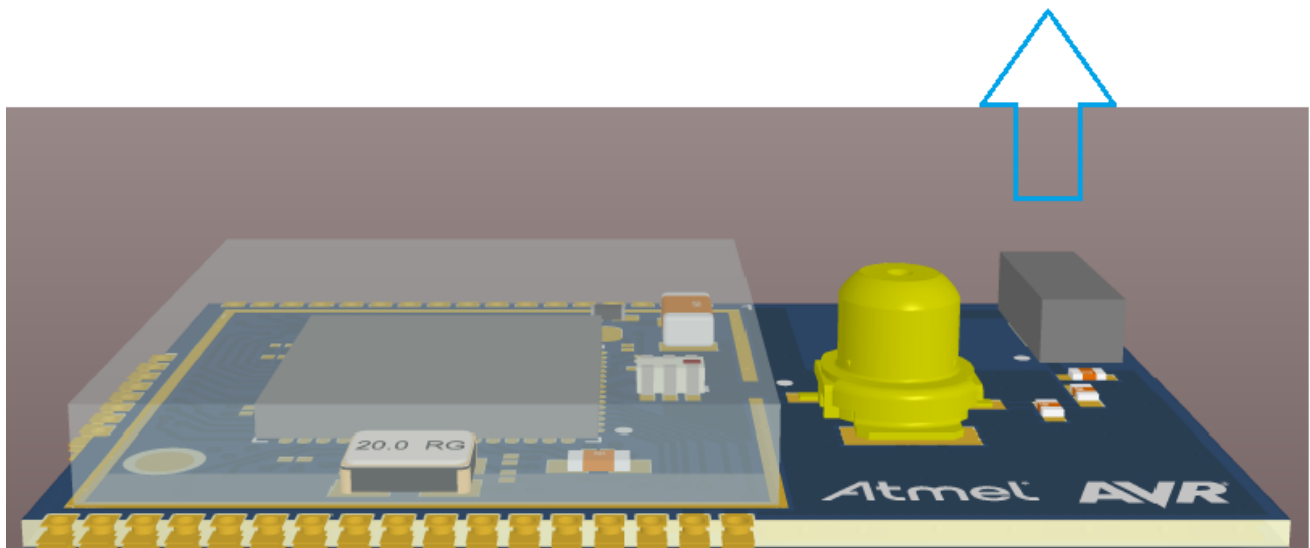

The Antenna in this module is designed to provide the best possible LoS range in the direction indicated in this illustration.

3.5 Mounting Information

The Figure below shows the PCB layout recommended for a ZigBit module. Neither via-holes nor wires are allowed on the PCB upper layer in the area occupied by the module. As a critical requirement, RF_GND pins should be grounded via several via-holes to be located right next to the pins thus minimizing inductance and preventing both mismatch and losses.

Figure 3-1. ATZB-S1-256-3-0-C Dimensions

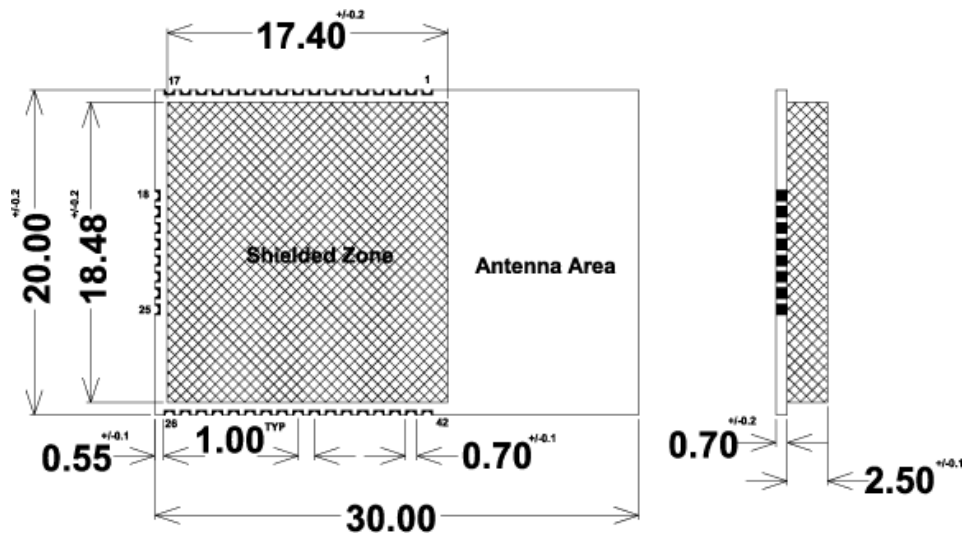

Figure 3-2. ATZB-S1-256-3-0-C Pinout

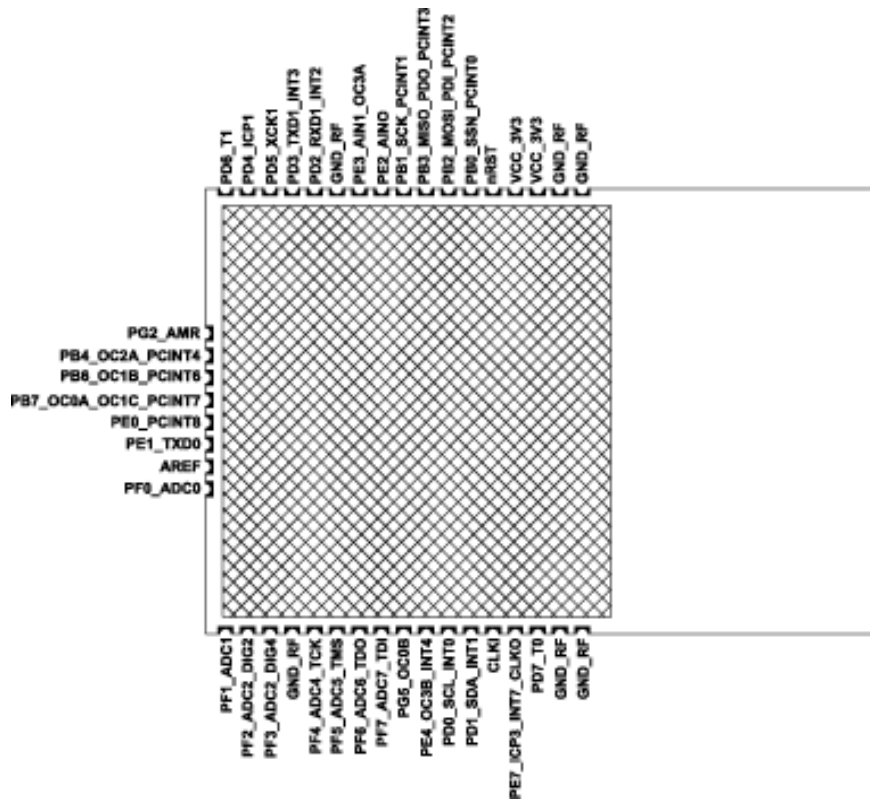

Figure 3-3. ATZB-S1-256-3-0-C Foot Print Dimensions

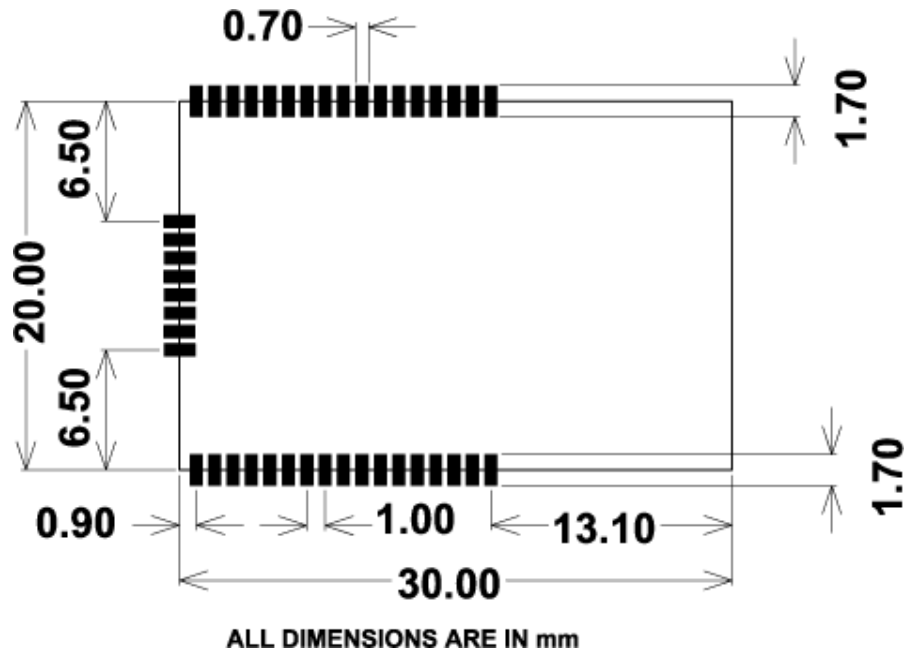

Figure 3-4. ATZB-S1-256-3-0-C Mounting Information (Preferred Placement)

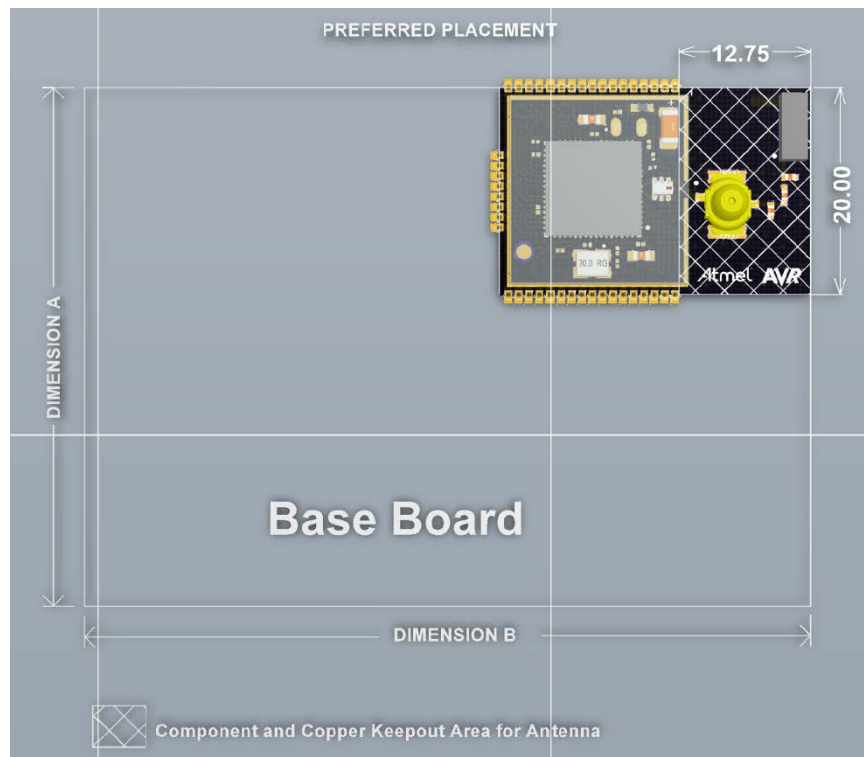
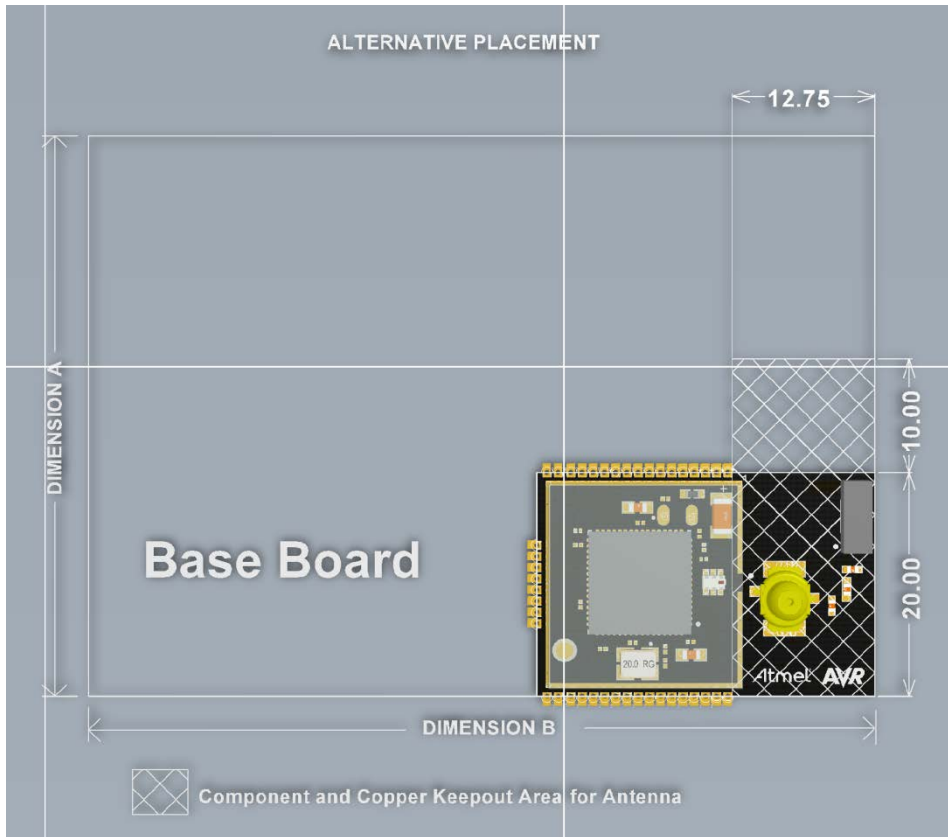

Figure 3-5. Figure 3-4. ATZB-S1-256-3-0-C Mounting Information (Preferred Placement)



The ZigBit's location and orientation on the carrier board is illustrated in the above Mounting information drawing. The Recommended placements of ZigBit on Carrier Board needs to be accurately followed to ensure performance on the end application.

Please note the areas in the Mounting information drawing for copper and component keep out to ensure superior performance of the ZigBits on your End application. Copper keep out recommended in the drawing applies for all layers of the carrier board

The dimension A of the carrier board should be equal to or greater than 20mm. Similarly, the dimension B should be equal to or greater than 30mm

3.6 Soldering Profile

The J-STD-020C-compliant soldering profile is recommended according to [Table 3-8](#).

Table 3-9. Soldering Profile⁽¹⁾.

Profile feature	Green package
Average ramp-up rate (217°C to peak)	3°C/s max
Preheat temperature 175°C ±25°C	180s max
Temperature maintained above 217°C	60s to 150s
Time within 5°C of actual peak temperature	20s to 40s
Peak temperature range	260°C

Profile feature	Green package
Ramp-down rate	6°C/s max
Time within 25°C to peak temperature	8 minutes

Note: 1. The package is backward compatible with PB/Sn soldering profile.

3.7 Antenna Reference Designs

Multiple factors affect proper antenna match, hence, affecting the antenna pattern. The particular factors are the board material and thickness, shields, the material used for enclosure, the board neighborhood, and other components adjacent to antenna. Following guidelines need to be followed when designing the base board for the ZigBit.

General Recommendations:

- Metal enclosure should not be used. Using low profile enclosure might also affect antenna tuning.
- Placing high profile components next to antenna should be avoided.
- Having holes/vias punched around the periphery of the board eliminates parasitic radiation from the board edges also distorting antenna pattern.
- ZigBit module should not be placed next to consumer electronics which might interfere with ZigBit's RF band frequency.

The board design should prevent propagation of microwave field inside the board material. Electromagnetic waves of high frequency may penetrate the board thus making the edges of the board radiate, which may distort the antenna pattern. To eliminate this effect, metalized and grounded holes/vias must be placed around the board's edges.

4. Schematics

The following schematic drawings for the ATZB-S1-256-3-0-c are in the following order_

- Top level schematics
- Connector schematics
- ATmega256RFR2 schematics
- ATmega256RFR2 RF antenna schematics

Connector
mega256RFR2_Connector.SchDoc

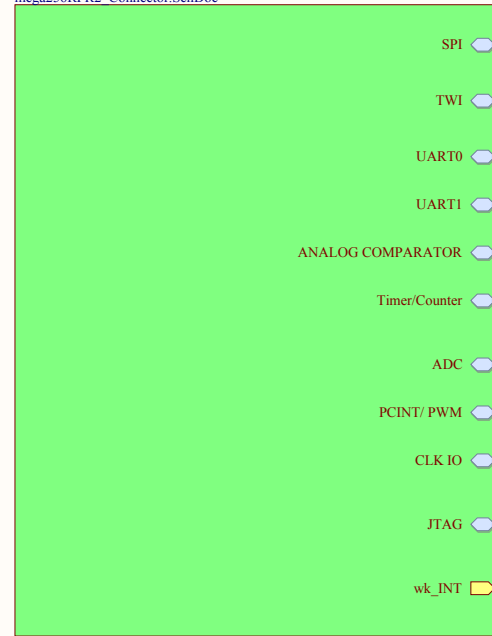

RFR2
mega256RFR2_RFR2.SchDoc

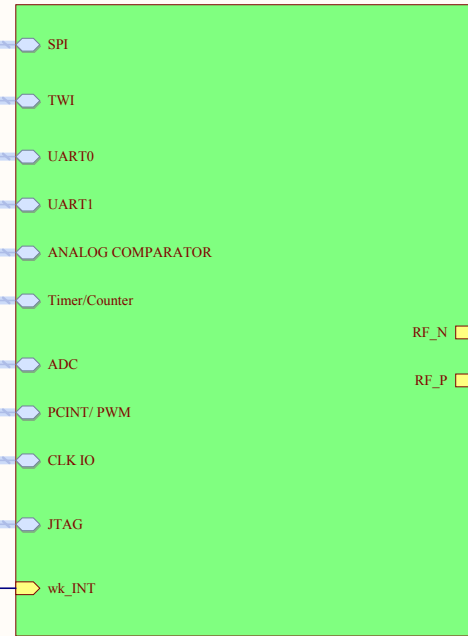

RF_Antenna

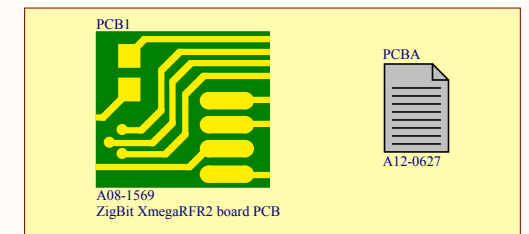
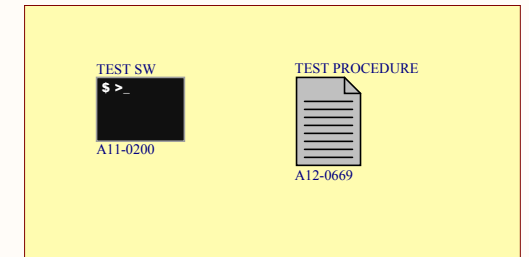
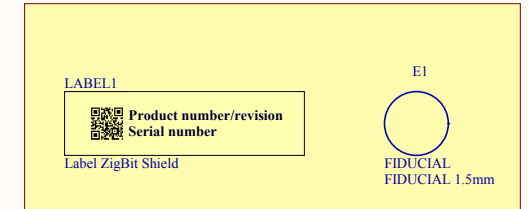
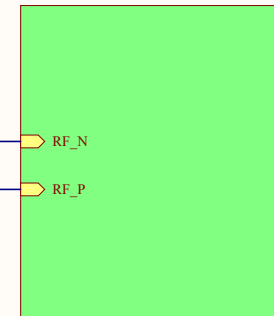

ATMEL Norway	Sanjay Yadav		 <small>Enabling Unlimited Possibilities</small>	
Vestre Rosten 79	MSK			
N-7075 TILLER	*			
NORWAY				
Date:	7/25/2013	2:34:35 PM	PAGE:	1 of 4
Document number:	*		Revision:	A
TITLE: *				
mega256RFR2_TopLevel.SchDoc				

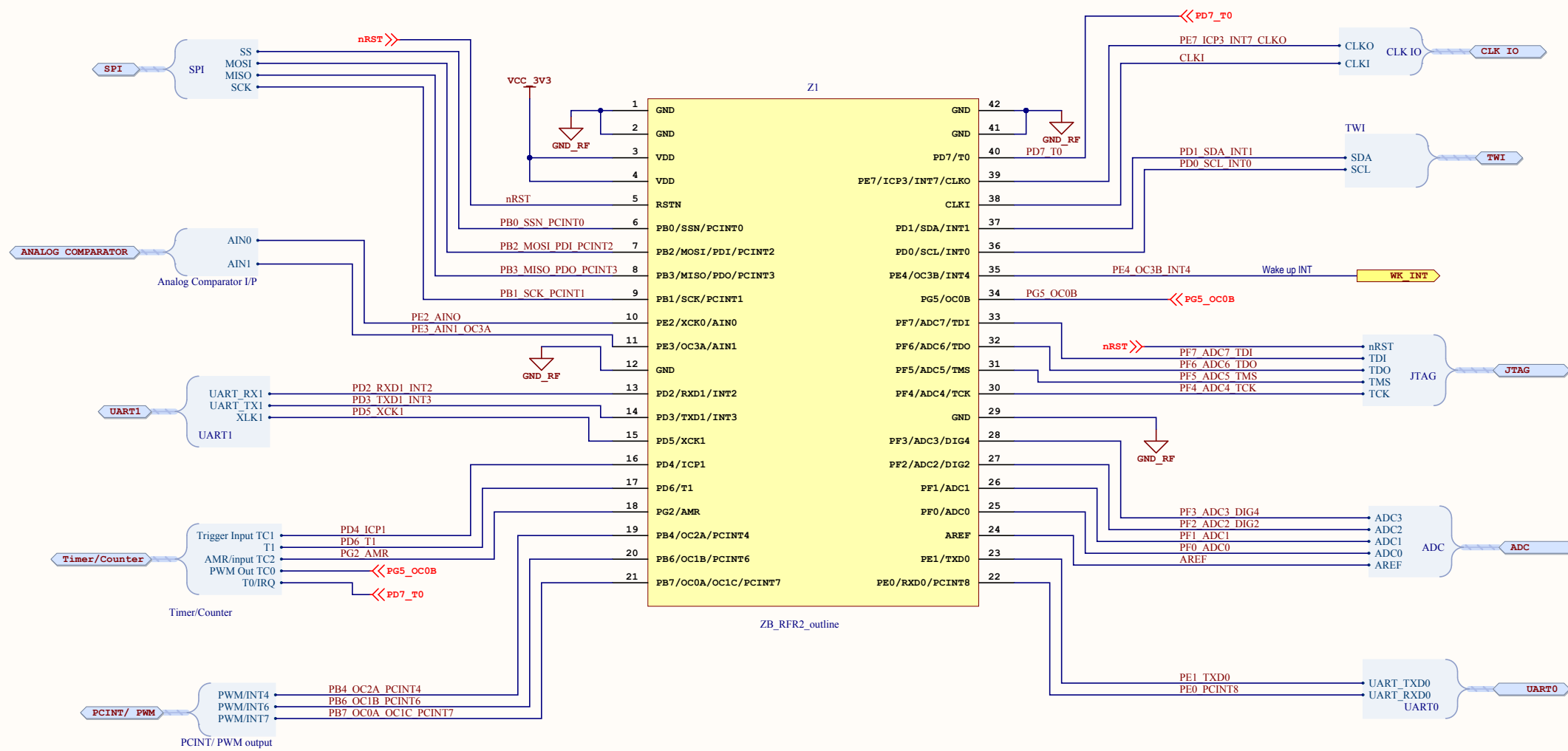

ATMEL Norway	Sanjay Yadav			
Vestre Rosten 79	MSK			
N-7075 TILLER	*			
NORWAY				
Date:	7/25/2013	2:34:35 PM	PAGE:	2 of 4
Document number:	*		Revision:	A
TITLE: *				
mega256RFR2_Connector_SchDoc				

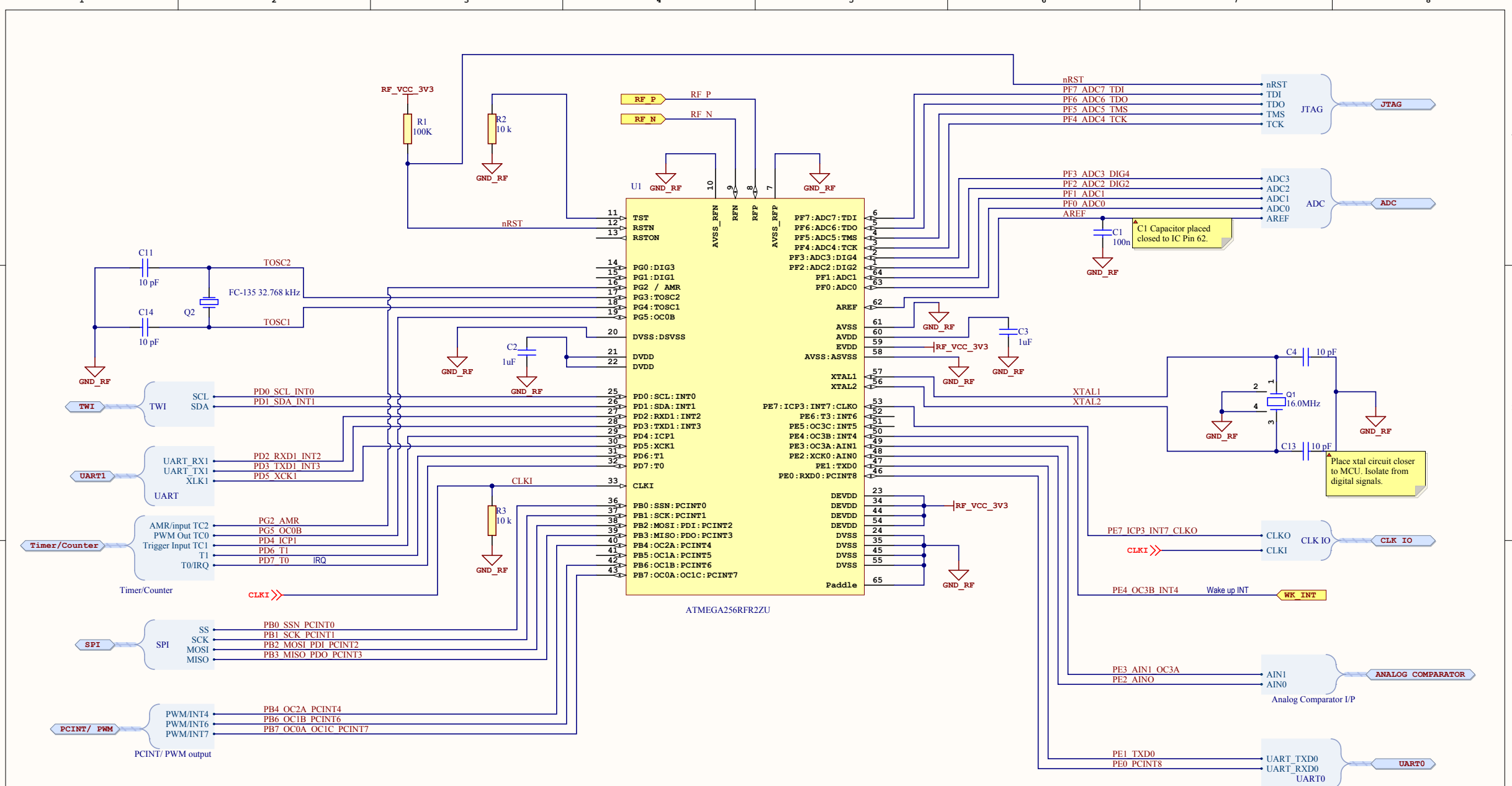

C1 Capacitor placed closer to IC Pin 62.

Place xtal circuit closer to MCU. Isolate from digital signals.

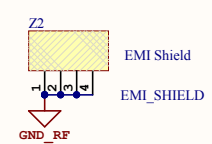
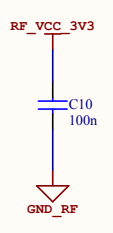
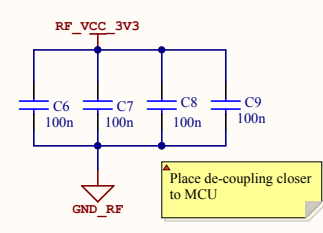
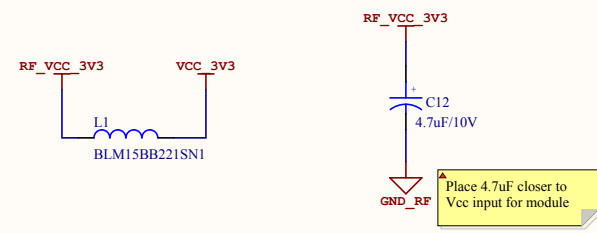

ATMEL Norway	Sanjay Yadav		
Vestre Rosten 79	MSK		
N-7075 TILLER	*		
NORWAY			
Date:	7/25/2013	2:34:35 PM	PAGE: 3 of 4
Document number:	*		Revision: A
TITLE: *			
mega256RFR2_RFR2_SchDoc			

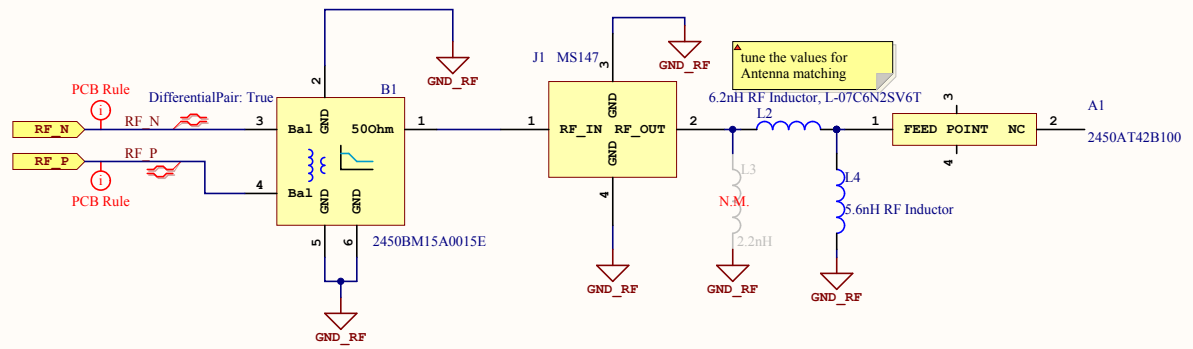

ATMEL Norway	Sanjay Yadav			
Vestre Rosten 79	MSK			
N-7075 TILLER	*			
NORWAY				
Date:	7/25/2013	2:34:35 PM	PAGE:	4 of 4
Document number:	*		Revision:	A
TITLE: *				
mega256RFR2_RF_Antenna.SchDoc				

4.1 Handling Instructions

The ZigBit Modules are fixed with an EMI Shield to ensure compliance to Emission and Immunity rules. This shield is galvanic and NOT air tight. So cleaning of the module with IPA / other similar agents is not advised. Humidity protection coating (conformal) will cause deviated RF behavior and coating material being trapped inside EMI Shield. So this should be avoided. For products requiring conformal coating, it is advised to suitably mask the ZigBit before applying the coating to rest of the ZigBit carrier board. To protect ZigBit from humidity, the housing of the product should ensure suitable Ingress Protection standards are complied with.

The MS-147 connector should never be exposed to Varnish / similar conformal coating material which will affect electrical connection on the surfaces of connector.

The in-built chip antenna has been tuned for the particular design

4.2 General Recommendations

- Metal enclosure should not be used. Using low profile enclosure might also affect antenna tuning
- Placing high profile components next to antenna should be avoided
- Having holes/vias punched around the periphery of the board eliminates parasitic radiation from the board edges also distorting antenna pattern
- ZigBit module should not be placed next to consumer electronics which might interfere with ZigBit's RF frequency band

5. Persistence Memory

A dedicated memory space is allocated to store product specific information and called the Persistence Memory. The organization of the persistence memory is as follows:

Table 5-1. Persistence Memory

Data	Size
Structure Revision	2 bytes
MAC address ⁽¹⁾	8 bytes
Board information overall	49 bytes
Board information – PCBA Name	30 bytes
Board information – PCBA Serial number	10 bytes
Board information – PCBA Atmel Part Number	8 bytes
Board information – PCBA Revision	1 byte
Reserved	3 bytes
Xtal Calibration Value	1 byte
Reserved	7 bytes
Reserved	4 bytes
CRC	2 bytes

In ATZB-S1-256-3-0-C persistence memory is stored in the User Signature Data (Page 1) of Atmega256RFR2 SoC with starting address 0x0100. User Signature Data is isolated from the main flash and will not be cleared by Chip erase Command.

Special commands are available to erase and write data to user signature pages via the JTAG interface (see section on "Programming via the JTAG Interface" in Atmega256RFR2 datasheet [1] for details). User signature rows can be read from software in the same way as the device and JTAG identifiers (see section "Reading the Signature Row from Software" of Atmega256RFR2 datasheet[1]).

Note: 1 The MAC address stored inside the MCU is a uniquely assigned ID for each ZigBit and owned by Atmel. User of the ZigBit application can use this unique MAC ID to address the ZigBit in end-applications. The MAC ID can be read from the ZigBit using the Performance Analyzer Application that can be downloaded from www.atmel.com/wireless

6. Ordering Information

Part number	Description
ATZB-S1-256-3-0-C	2.4GHz IEEE802.15.4/ZigBee OEM module based on ATmega256RFR2 SoC with MS-147 test connector and chip antenna, Single unit
ATZB-S1-256-3-0-CR	2.4GHz IEEE802.15.4/ZigBee OEM module based on ATmega256RFR2 SoC with MS-147 test connector and chip antenna, tape and reel

Note: Tape and reel quantity: 200.

7. Agency Certifications

7.1 United States (FCC)

This equipment complies with Part 15 of the FCC rules and regulations. To fulfill FCC Certification requirements, an OEM manufacturer must comply with the following regulations:

1. The ATZB-S1-256-3-0-C modular transmitter must be labeled with its own FCC ID number, and, if the FCC ID is not visible when the module is installed inside another device, then the outside of the device into which the module is installed must also display a label referring to the enclosed module. This exterior label can use wording such as the following:

IMPORTANT: Contains FCC ID : VW4A091732. This equipment complies with Part 15 of the FCC Rules. Operation is subject to the following two conditions: (1) this device may not cause harmful interference, and (2) this device must accept any interference received, including interference that may cause undesired operation (FCC 15.19).

The internal antenna used for this mobile transmitter must provide a separation distance of at least 20 cm from all persons and must not be colocated or operating in conjunction with any other antenna or transmitter.

Installers must be provided with antenna installation instructions and transmitter operating conditions for satisfying RF exposure compliance. This device is approved as a mobile device with respect to RF exposure compliance, and may only be marketed to OEM installers. Use in portable exposure conditions (FCC 2.1093) requires separate equipment authorization.

IMPORTANT: Modifications not expressly approved by this company could void the user's authority to operate this equipment (FCC section 15.21).

IMPORTANT: This equipment has been tested and found to comply with the limits for a Class A digital device, pursuant to Part 15 of the FCC Rules. These limits are designed to provide reasonable protection against harmful interference when the equipment is operated in a commercial environment. This equipment generates, uses, and can radiate radio frequency energy and, if not installed and used in accordance with the instruction manual, may cause harmful interference to radio communications. Operation of this equipment in a residential area is likely to cause harmful interference in which case the user will be required to correct the interference at his own expense (FCC section 15.105).

7.2 European Union (ETSI)

The ATZB-S1-256-3-0-C Module has been certified for use in European Union countries. If these modules are incorporated into a product, the manufacturer must ensure compliance of the final product to the European harmonized EMC and lowvoltage/safety standards. A Declaration of Conformity must be issued for each of these standards and kept on file as described in Annex II of the R&TTE Directive.

Furthermore, the manufacturer must maintain a copy of the modules' documentation and ensure the final product does not exceed the specified power ratings, antenna specifications, and/or installation requirements as specified in the user manual. If any of these specifications are exceeded in the final product, a submission must be made to a notified body for compliance testing to all required standards.

IMPORTANT: The 'CE' marking must be affixed to a visible location on the OEM product. The CE mark shall consist of the initials "CE" taking the following form:

The CE marking must have a height of at least 5mm except where this is not possible on account of the nature of the apparatus.

The CE marking must be affixed visibly, legibly, and indelibly.

More detailed information about CE marking requirements you can find at "DIRECTIVE 1999/5/EC OF THE EUROPEAN PARLIAMENT AND OF THE COUNCIL" on 9 March 1999 at section 12.

7.3 Industry Canada (IC) Compliance statements

This device complies with Industry Canada licence-exempt RSS standard(s). Operation is subject to the following two conditions: (1) this device may not cause interference, and (2) this device must accept any interference, including interference that may cause undesired operation of the device.

Le présent appareil est conforme aux CNR d'Industrie Canada applicables aux appareils radio exempts de licence. L'exploitation est autorisée aux deux conditions suivantes : (1) l'appareil ne doit pas produire de brouillage, et (2) l'utilisateur de l'appareil doit accepter tout brouillage radioélectrique subi, même si le brouillage est susceptible d'en compromettre le fonctionnement.

This equipment complies with radio frequency exposure limits set forth by Industry Canada for an uncontrolled environment. This equipment should be installed and operated with minimum distance 20 cm between the device and the user or bystanders.

Cet équipement est conforme aux limites d'exposition aux radiofréquences définies par Industrie Canada pour un environnement non contrôlé. Cet équipement doit être installé et utilisé avec un minimum de 20 cm de distance entre le dispositif et l'utilisateur ou des tiers

CAUTION: Any changes or modifications not expressly approved by the party responsible for compliance could void the user's authority to operate the equipment.

The OEM integrator is still responsible for testing their end-product for any additional compliance requirements required with this module installed (for example, digital device emissions, PC peripheral requirements, etc.).

This Module is labelled with its own IC ID. If the IC ID Certification Number is not visible while installed inside another device, then the device should display the label on it referring the enclosed module. In that case, the final end product must be labelled in a visible area with the following:

"Contains Transmitter Module IC:11019A-091732"

OR

"Contains IC: 11019A-091732"

Ce module est étiqueté avec son propre ID IC. Si le numéro de certification IC ID n'est pas visible lorsqu'il est installé à l'intérieur d'un autre appareil, l'appareil doit afficher l'étiquette sur le module de référence ci-joint. Dans ce cas, le produit final doit être étiqueté dans un endroit visible par le texte suivant:

"Contains Transmitter Module IC: 11019A-091732"

OR

"Contains IC: 11019A-091732"

8. Revision History

Doc. Rev.	Date	Comments
42191A	11/2013	Initial revision.



Atmel Corporation

1600 Technology Drive
San Jose, CA 95110
USA

Tel: (+1)(408) 441-0311

Fax: (+1)(408) 487-2600

www.atmel.com

Atmel Asia Limited

Unit 01-5 & 16, 19F
BEA Tower, Millennium City 5
418 Kwun Tong Road
Kwun Tong, Kowloon
HONG KONG

Tel: (+852) 2245-6100

Fax: (+852) 2722-1369

Atmel Munich GmbH

Business Campus
Parking 4
D-85748 Garching b. Munich
GERMANY

Tel: (+49) 89-31970-0

Fax: (+49) 89-3194621

Atmel Japan G.K.

16F Shin-Osaki Kangyo Building
1-6-4 Osaki
Shinagawa-ku, Tokyo 141-0032
JAPAN

Tel: (+81)(3) 6417-0300

Fax: (+81)(3) 6417-0370

© 2013 Atmel Corporation. All rights reserved. / Rev.: 42191A–WIRELESS–11/2013

Atmel®, Atmel logo and combinations thereof, Enabling Unlimited Possibilities®, AVR®, ZigBit®, and others are registered trademarks or trademarks of Atmel Corporation or its subsidiaries. Other terms and product names may be trademarks of others.

Disclaimer: The information in this document is provided in connection with Atmel products. No license, express or implied, by estoppel or otherwise, to any intellectual property right is granted by this document or in connection with the sale of Atmel products. EXCEPT AS SET FORTH IN THE ATMEL TERMS AND CONDITIONS OF SALES LOCATED ON THE ATMEL WEBSITE, ATMEL ASSUMES NO LIABILITY WHATSOEVER AND DISCLAIMS ANY EXPRESS, IMPLIED OR STATUTORY WARRANTY RELATING TO ITS PRODUCTS INCLUDING, BUT NOT LIMITED TO, THE IMPLIED WARRANTY OF MERCHANTABILITY, FITNESS FOR A PARTICULAR PURPOSE, OR NON-INFRINGEMENT. IN NO EVENT SHALL ATMEL BE LIABLE FOR ANY DIRECT, INDIRECT, CONSEQUENTIAL, PUNITIVE, SPECIAL OR INCIDENTAL DAMAGES (INCLUDING, WITHOUT LIMITATION, DAMAGES FOR LOSS AND PROFITS, BUSINESS INTERRUPTION, OR LOSS OF INFORMATION) ARISING OUT OF THE USE OR INABILITY TO USE THIS DOCUMENT, EVEN IF ATMEL HAS BEEN ADVISED OF THE POSSIBILITY OF SUCH DAMAGES. Atmel makes no representations or warranties with respect to the accuracy or completeness of the contents of this document and reserves the right to make changes to specifications and products descriptions at any time without notice. Atmel does not make any commitment to update the information contained herein. Unless specifically provided otherwise, Atmel products are not suitable for, and shall not be used in, automotive applications. Atmel products are not intended, authorized, or warranted for use as components in applications intended to support or sustain life.