

### Features

- ✧ Low profile package
- ✧ Built-in strain relief
- ✧ Glass passivated junction
- ✧ Low inductance
- ✧ Typical  $I_R$  less than 5uA above 11V
- ✧ High temperature soldering guaranteed:  
260°C / 10 seconds at terminals
- ✧ Plastic package has Underwriters  
Laboratory Flammability Classification 94V-0
- ✧ Green compound with suffix "G" on packing  
code & prefix "G" on datecode

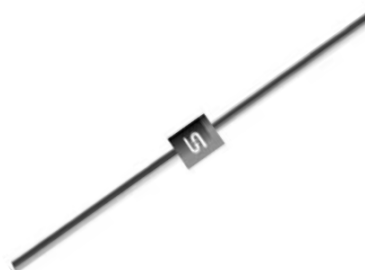

### Mechanical Data

- ✧ Case: Molded plastic DO-41
- ✧ Epoxy: UL 94V-0 rate flame retardant
- ✧ Lead: Pure tin plated, lead free,  
solderable per MIL-STD-202, method 2025
- ✧ Polarity: Color Band denotes cathode end
- ✧ Mounting position: Any
- ✧ Weight: 0.3 gram

### Ordering Information (example)

Part No.	Package	Packing	INNER TAPE	Packing code	Packing code (Green)
1N4740A	DO-41	3K / AMMO box	52mm	A0	A0G

### Maximum Ratings and Electrical Characteristics

Rating at 25 °C ambient temperature unless otherwise specified.

Parameter	Symbol	Value	Unit
Peak Power Dissipation at TA=50°C, Derate above 50°C (Note 1)	$P_D$	1.0 6.67	Watts mW/°C
Peak Forward Surge Current, 8.3ms Single Half Sine-wave Superimposed on Rated Load (JEDEC method)(Note 2)	$I_{FSM}$	10	Amps
Operating and Storage Temperature Range	$T_J, T_{STG}$	-55 to +150	°C

Note 1: Mounted on Cu-Pad size 5mm x 5mm x 1.6mm on PCB

Note 2: Measure on 8.3ms Single half Sine-Wave of equivalent square wave, duty cycle= 4 pulse per minute maximum

**ELECTRICAL CHARACTERISTICS (TA=25°C unless otherwise noted)**

Device (Note 1)	Zener Voltage			Test Current	Zener Impedance			Leakage Current		Surge current TA=25°C
	Vz@IzT			IzT	ZzT@IzT	ZzK@IzK		IR@VR		IR
	V			mA	Ω	Ω	mA	uA	V	mA
	Min.	Nom. (Note 2) (Note 3)	Max.					Max.		
1N4740A	9.50	10	10.50	25.0	7	700	0.25	10	7.6	454
1N4741A	10.45	11	11.55	23.0	8	700	0.25	5	8.4	414
1N4742A	11.40	12	12.60	21.0	9	700	0.25	5	9.1	380
1N4743A	12.35	13	13.65	19.0	10	700	0.25	5	9.9	344
1N4744A	14.25	15	15.75	17.0	14	700	0.25	5	11.4	304
1N4745A	15.20	16	16.80	15.5	16	700	0.25	5	12.2	285
1N4746A	17.10	18	18.90	14.0	20	750	0.25	5	13.7	250
1N4747A	19.00	20	21.00	12.5	22	750	0.25	5	15.2	225
1N4748A	20.90	22	23.10	11.5	23	750	0.25	5	16.7	205
1N4749A	22.80	24	25.20	10.5	25	750	0.25	5	18.2	190
1N4750A	25.65	27	28.35	9.5	35	750	0.25	5	20.6	170
1N4751A	28.50	30	31.50	8.5	40	1000	0.25	5	22.8	150
1N4752A	31.35	33	34.65	7.5	45	1000	0.25	5	25.1	135
1N4753A	34.20	36	37.80	7.0	50	1000	0.25	5	27.4	125
1N4754A	37.05	39	40.95	6.5	60	1000	0.25	5	29.7	115
1N4755A	40.85	43	45.15	6.0	70	1500	0.25	5	32.7	110
1N4756A	44.65	47	49.35	5.5	80	1500	0.25	5	35.8	95
1N4757A	48.45	51	53.55	5.0	95	1500	0.25	5	38.8	90
1N4758A	53.20	56	58.80	4.5	110	2000	0.25	5	42.6	80
1N4759A	58.90	62	65.10	4.0	125	2000	0.25	5	47.1	70
1N4760A	64.60	68	71.40	3.7	150	2000	0.25	5	51.7	65
1N4761A	71.25	75	78.75	3.3	175	2000	0.25	5	56.0	60
1N4762A	77.90	82	86.10	3.0	200	3000	0.25	5	62.2	55
1N4763A	86.45	91	95.55	2.8	250	3000	0.25	5	69.2	50
1N4764A	95.00	100	105.00	2.5	350	3000	0.25	5	76.0	45
1M110Z	104.50	110	115.50	2.3	450	4000	0.25	5	83.6	-
1M120Z	114.00	120	126.00	2.0	550	4500	0.25	5	91.2	-
1M130Z	123.50	130	136.50	1.9	700	5000	0.25	5	98.8	-
1M150Z	142.50	150	157.50	1.7	1000	6000	0.25	5	114.0	-
1M160Z	152.00	160	168.00	1.6	1100	6500	0.25	5	121.6	-
1M180Z	171.00	180	189.00	1.4	1200	7000	0.25	5	136.8	-
1M200Z	190.00	200	210.00	1.2	1500	8000	0.25	5	152.0	-

**Notes:**

1. Tolerance and Type Number Designation. The type numbers listed have a standard tolerance on the nominal zener voltage of  $\pm 5\%$
2. Specials Available Include:
  - A. Nominal zener voltages between the voltages shown and tighter voltage tolerances
  - B. Matched sets
3. Zener Voltage (Vz) Measurement. Guarantees the zener voltage when measured at 90 seconds while maintaining the lead temperature (TL) at  $30^{\circ}\text{C} \pm 1^{\circ}\text{C}$ , from the diode body
4. Zener Impedance (Zz) Derivation. The zener impedance is derived from the 60 cycle AC voltage, which results when an accurate having and rms value equal to 10% of the DC zener current ( $I_{zT}$  or  $I_{zK}$ ) is superimposed on  $I_{zT}$  or  $I_{zK}$
5. Surge Current ( $I_R$ ) Non-Repetitive. The rating listed in the electrical characteristics table is maximum peak, non-repetitive, reverse surge current of 1/2 square wave or equivalent sine wave pulse of 1/120 second duration superimposed on the test current,  $I_{zT}$  per JEDEC registration; however, actual device capability is as described in Figure 11

RATINGS AND CHARACTERISTIC CURVES (1N4740A THRU 1M200Z)

FIG. 1 POWER TEMPERATURE DERATING CURVE

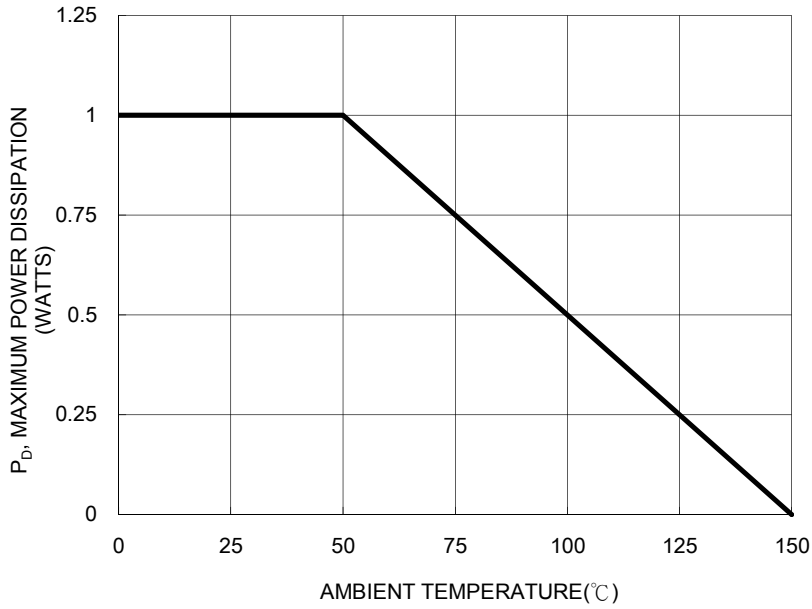

FIG. 2 TYPICAL FORWARD CHARACTERISTICS

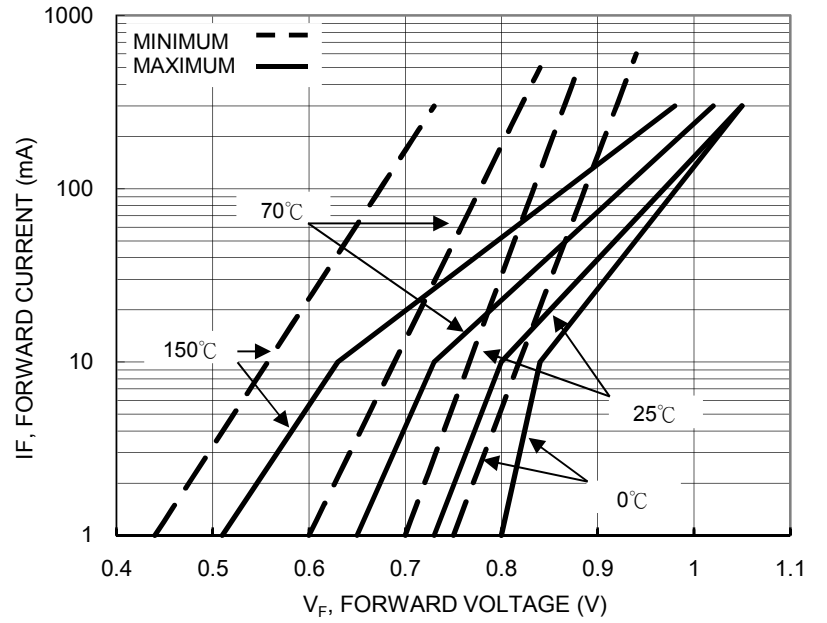

FIG.3 EFFECT OF ZENER CURRENT ON ZENER IMPEDANCE

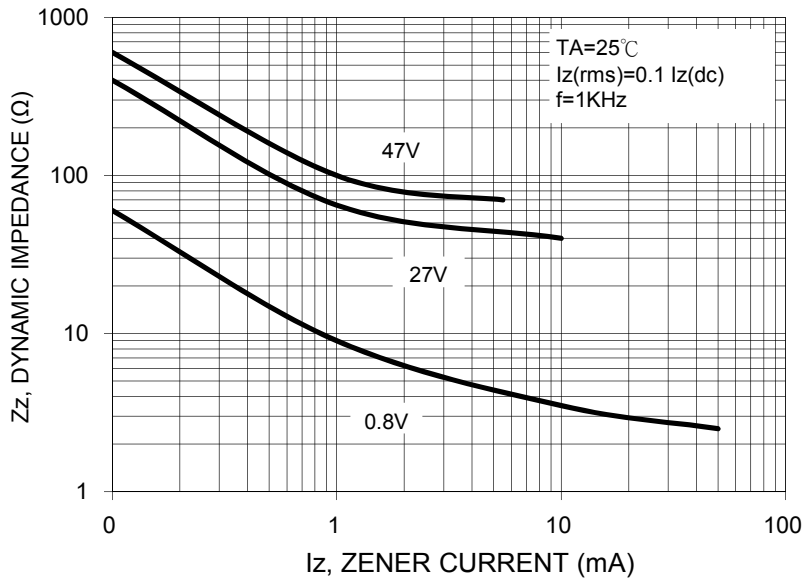

FIG.5 TYPICAL LEAKAGE CURRENT

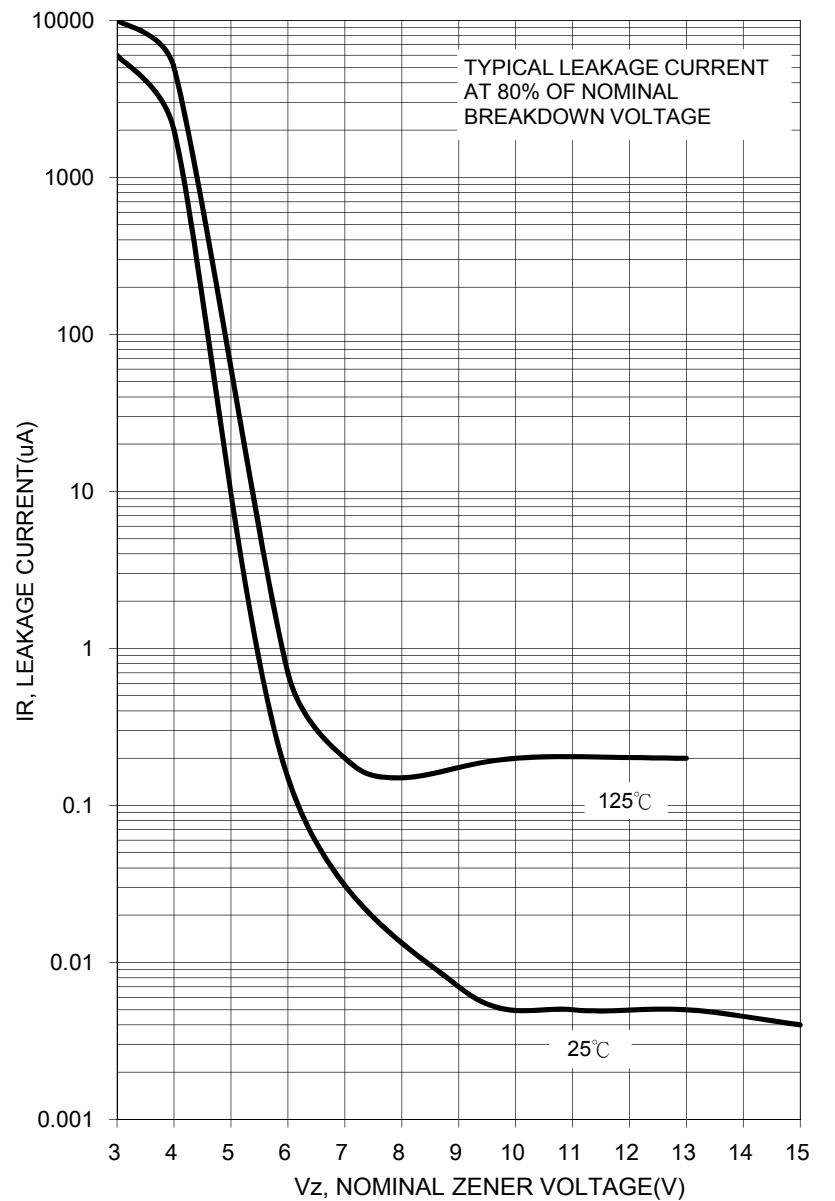
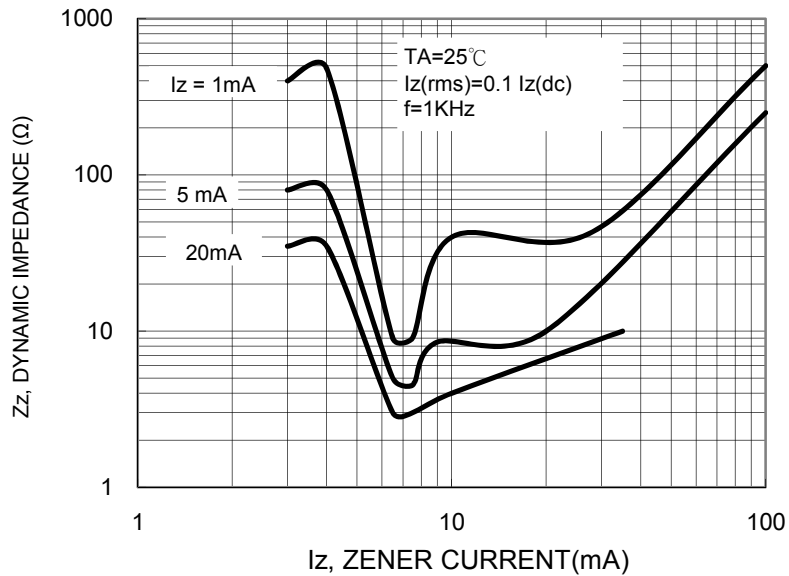

FIG.4 EFFECT OF ZENER VOLTAGE ON ZENER IMPEDANCE



RATINGS AND CHARACTERISTIC CURVES (1N4740A THRU 1M200Z)

FIG.6 TYPICAL CAPACITANCE versus Vz

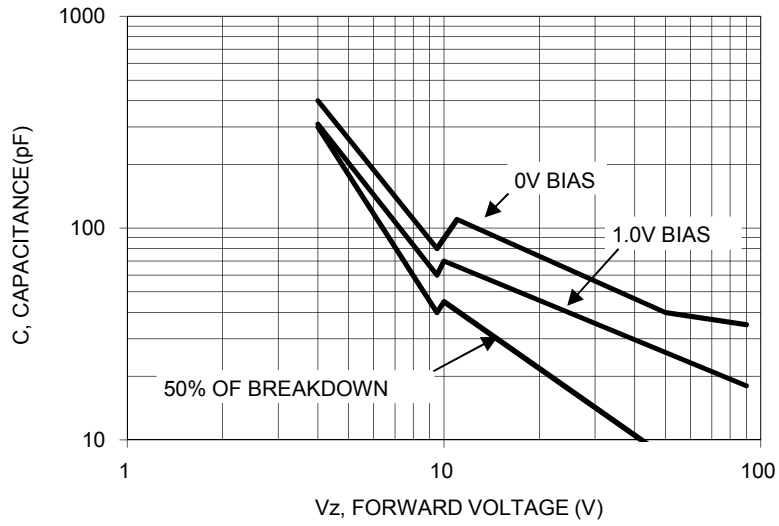

FIG. 7 TEMPERATURE COEFFICIENTS

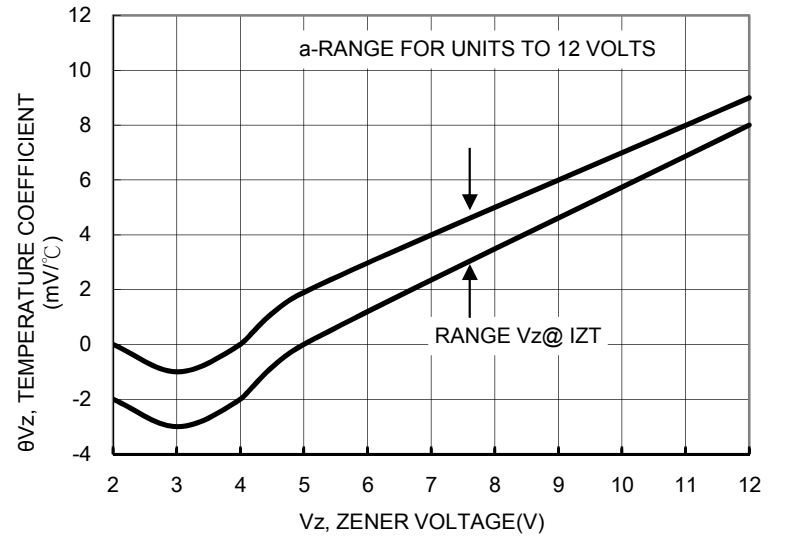

FIG.8 TEMPERATURE COEFFICIENTS

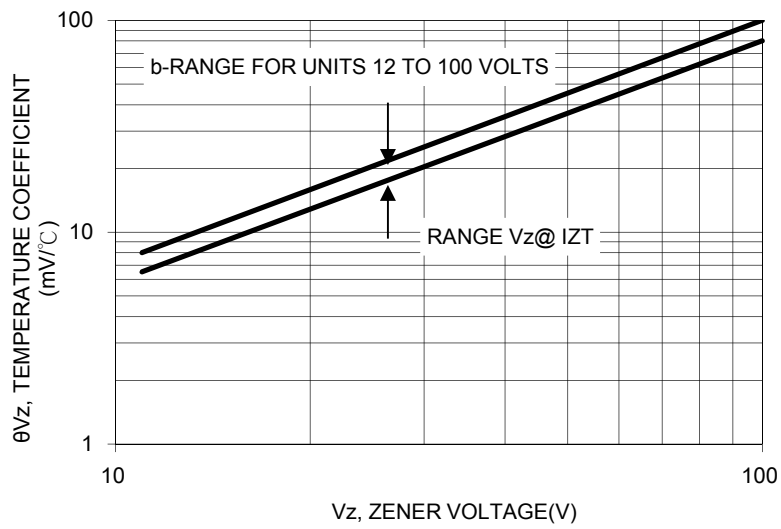

FIG. 9 EFFECT OF ZENER CURRENT

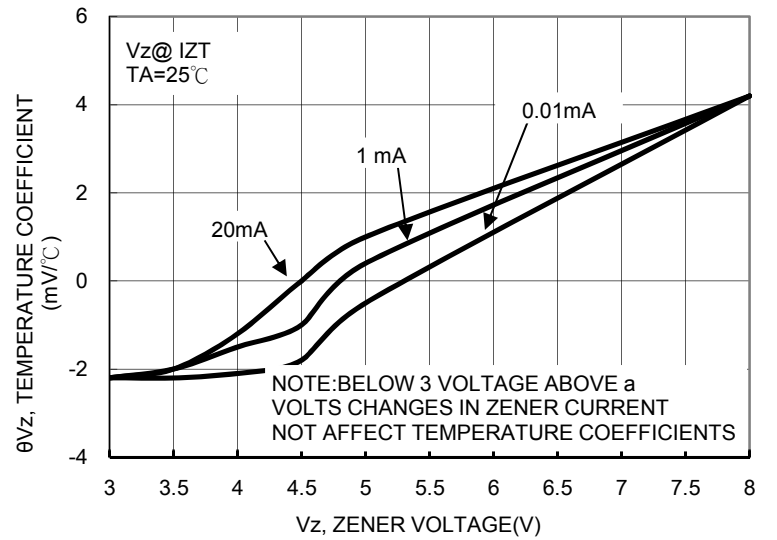
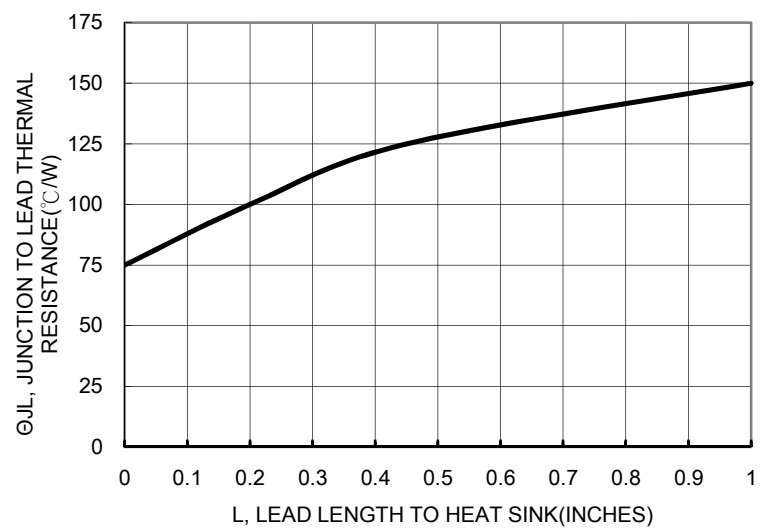
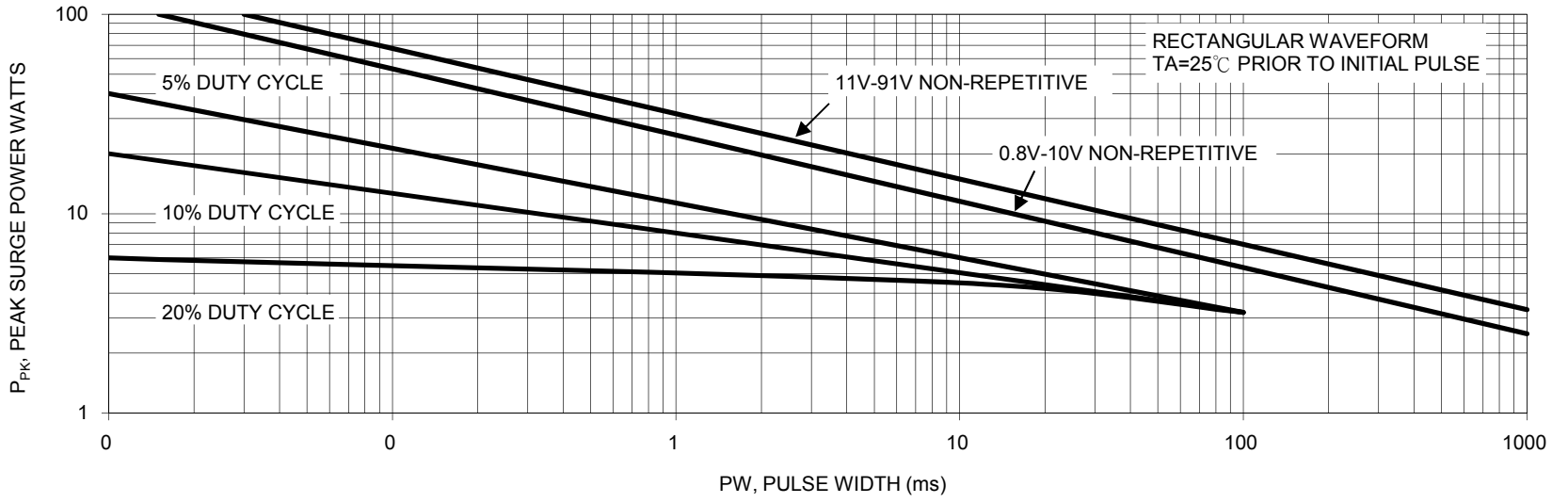

FIG. 10 TYPICAL THERMAL RESISTANCE versus LEAD LENGTH



RATINGS AND CHARACTERISTIC CURVES (1N4740A THRU 1M200Z)

FIG.11 MAXIMUM SURGE POWER



**Ordering information**

Part No.	Package	Packing	INNER TAPE	Packing code	Packing code (Green)
1N46xxA 1MxxxZ (Note)	DO-41	3K / AMMO box	52mm	A0	A0G
	DO-41	3K / AMMO box	26mm	A1	A1G
	DO-41	5K / 13" Reel	52mm	R0	R0G
	DO-41	5K / 13" Reel(Reverse)	52mm	R1	R1G
	DO-41	1K / Bulk packing		B0	B0G

Note: "xx" is Device Code from 1N47"40"A thru "94"A, 1M"110"Z thru "200"Z

**AXIAL LEAD TAPING SPECIFICATIONS**

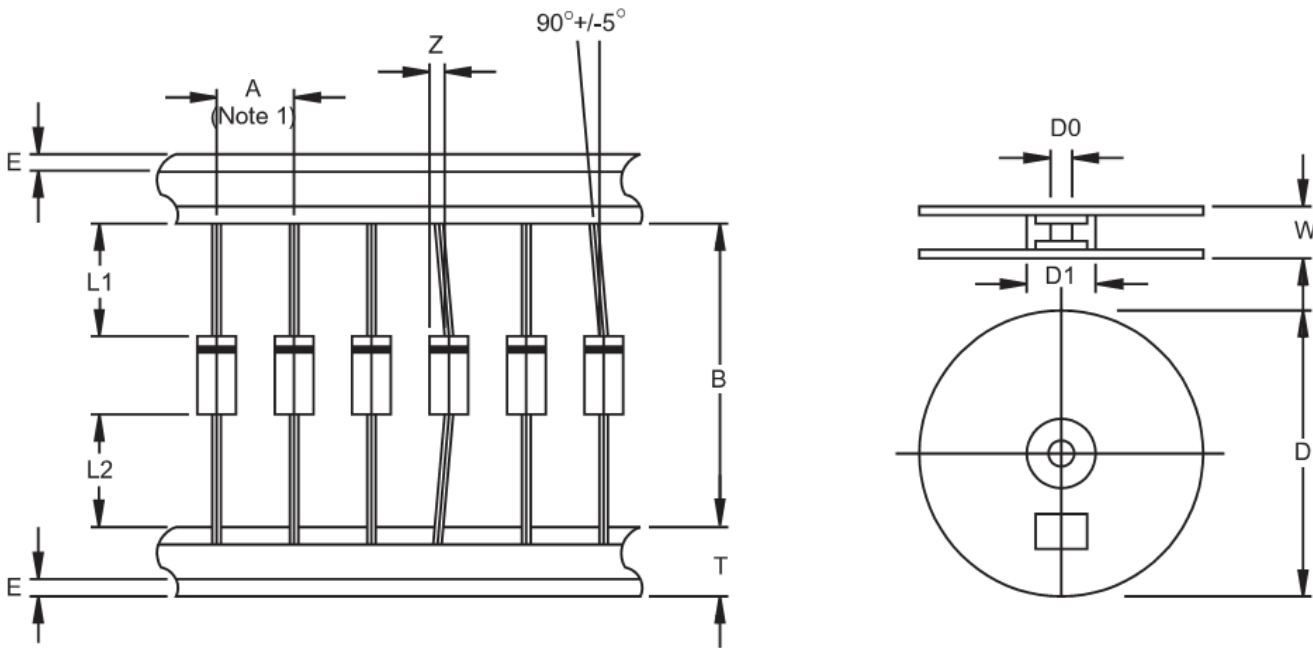

Outline	A	B	Z	T	E	L1-L2	D	D1	D0	W
	±0.5	±1.5	MAX	±0.4	MAX	MAX		±0.3	±0.4	±1.0
DO-41	5	26	1.2	6	0.8	1	330	85.7	16.6	76
DO-41	5	52.4	1.2	6	0.8	1	330	85.7	16.6	76

Unit (mm)

**Suggested Mounting Hole Rule**

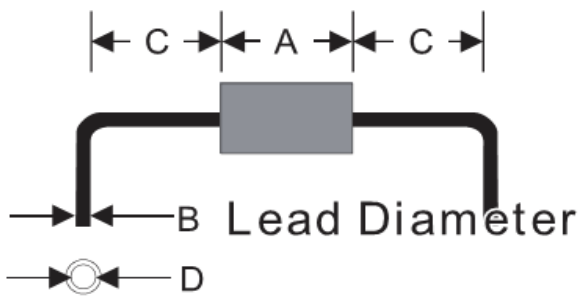

Symbol	Unit(mm)
A	5.1
B	0.8
C	3.0
D	1.2

**Dimensions**

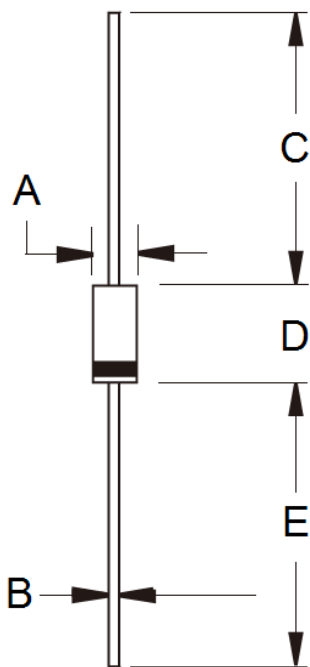

DIM.	Unit(mm)		Unit(inch)	
	Min	Max	Min	Max
A	2.00	2.70	0.079	0.106
B	0.71	0.86	0.028	0.034
C	25.40	-	1.000	-
D	4.20	5.20	0.165	0.205
E	25.40	-	1.000	-

**Marking Diagram**



- P/N = Specific Device Code
- G = Green Compound
- YWW = Date Code
- F = Factory Code