

Features

- ✧ UL Recognized File # E-326243
- ✧ Plastic package has Underwriters Laboratory Flammability Classification 94V-0
- ✧ 600 watts surge capability at 10 x 1000 us waveform
- ✧ Excellent clamping capability
- ✧ Low Dynamic impedance
- ✧ Fast response time: Typically less than 1.0ps from 0 volt to VBR for unidirectional and 5.0ns for bidirectional
- ✧ Typical I_R less than 1uA above 10V
- ✧ High temperature soldering guaranteed: 260°C / 10 seconds
- ✧ Green compound with suffix "G" on packing code & prefix "G" on datecode

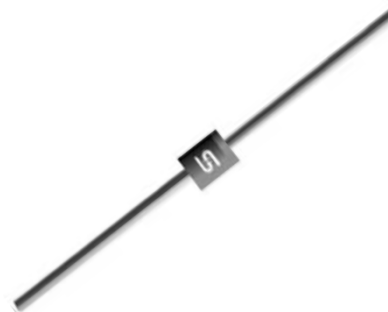

Mechanical Data

- ✧ Case: Molded plastic
- ✧ Lead: Pure tin plated lead free, solderable per MIL-STD-202, Method 208
- ✧ Polarity: Color band denotes cathode except bipolar
- ✧ Weight: 0.42 gram

Ordering Information (example)

Part No.	Package	Packing	INNER TAPE	Packing code	Packing code (Green)
P6KE6.8	DO-15	1.5K / AMMO box	52mm	A0	A0G

Maximum Ratings and Electrical Characteristics

Rating at 25 °C ambient temperature unless otherwise specified.

Parameter	Symbol	Value	Unit
Peak Power Dissipation at $T_A=25^\circ\text{C}$, $T_p=1\text{ms}$ (Note 1)	P_{PK}	600	Watts
Steady State Power Dissipation at $T_L=75^\circ\text{C}$ Lead Lengths .375", 9.5mm (Note 2)	P_D	5	Watts
Peak Forward Surge Current, 8.3ms Single Half Sine-wave Superimposed on Rated Load (JEDEC method)(Note 3)	I_{FSM}	100	Amps
Maximum Instantaneous Forward Voltage at 50A for Unidirectional Only (Note 4)	V_F	3.5 / 5.0	Volts
Typical Thermal Resistance	$R_{\theta JL}$ $R_{\theta JA}$	10 62	$^\circ\text{C/W}$
Operating and Storage Temperature Range	T_J, T_{STG}	-55 to +175	$^\circ\text{C}$

Note 1: Non-repetitive Current Pulse Per Fig. 3 and Derated above $T_A=25^\circ\text{C}$ Per Fig. 2

Note 2: Mounted on Copper Pad Area 0.4" x 0.4"(10mm x 10mm)

Note 3: 8.3ms Single Half Sine-wave or Equivalent Square Wave, Duty Cycle=4 Pulses Per Minute Maximum

Note 4: $V_F=3.5\text{V}$ for Devices of $V_{BR} \leq 200\text{V}$ and $V_F=5.0\text{V}$ Max. for Device $V_{BR} > 200\text{V}$

Devices for Bipolar Applications

1. For Bidirectional Use C or CA Suffix for Types P6KE6.8 through Types P6KE440
2. Electrical Characteristics Apply in Both Directions

RATINGS AND CHARACTERISTIC CURVES (P6KE SERIES)

FIG. 1 PEAK PULSE POWER RATING CURVE

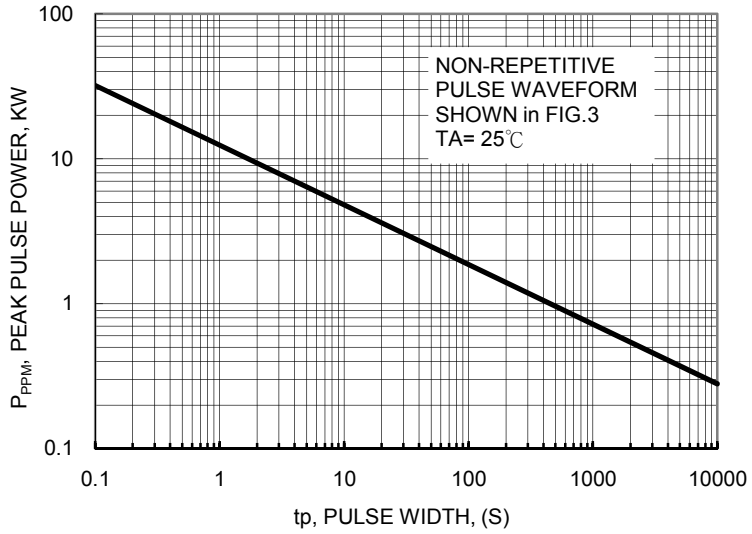

FIG.2 PULSE DERATING CURVE

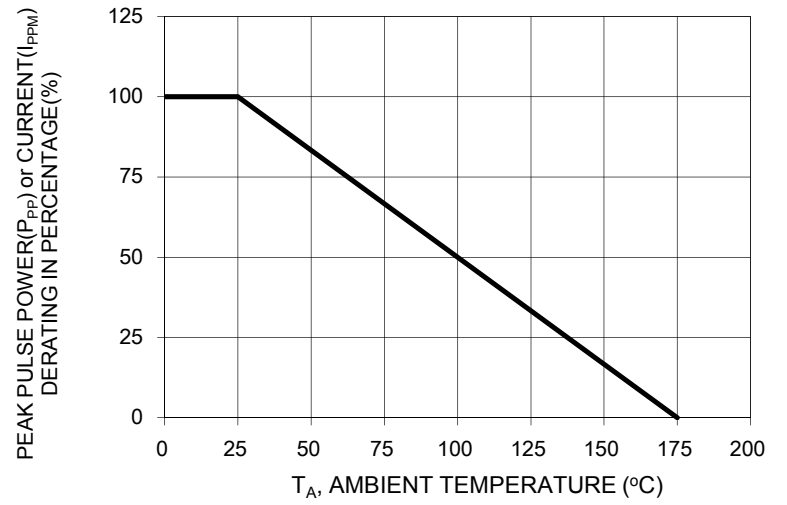

FIG. 3 CLAMPING POWER PULSE WAVEFORM

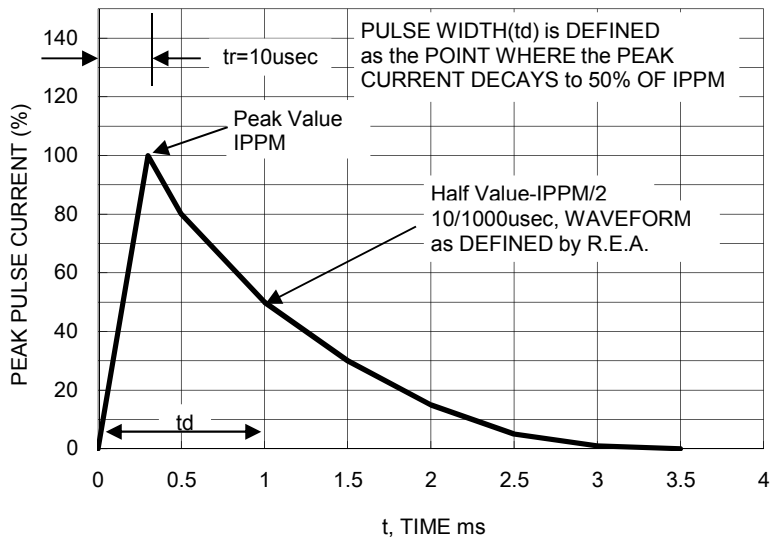

FIG. 4 MAXIMUM NON-REPETITIVE FORWARD SURGE CURRENT UNIDIRECTIONAL ONLY

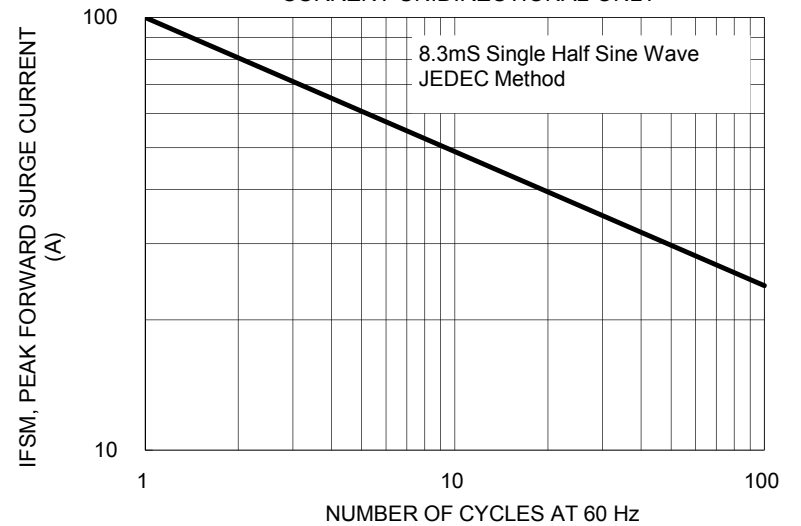
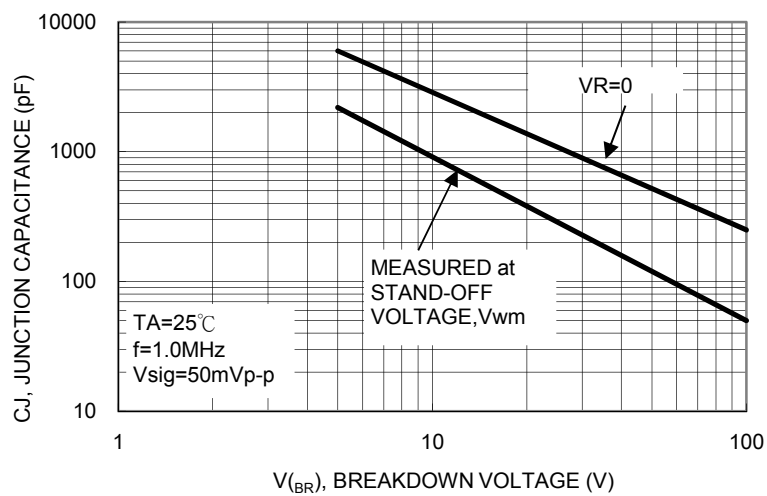

FIG. 5 TYPICAL JUNCTION CAPACITANCE



ELECTRICAL CHARACTERISTICS (TA=25°C unless otherwise noted)

General Part Number	Nominal Voltage	Breakdown Voltage (Note 1)		Test Current	Stand-Off Voltage	Maximum Reverse Leakage @ V _{WM}	Maximum Peak Surge Current	Maximum Clamping Voltage @ I _{PPM}	Maximum Temperature Coefficient
		V _{BR}		I _T	V _{WM}	I _D	I _{PPM}	V _C	of V _{BR}
	(V)	(V)		(mA)	(V)	(uA)	(A)	(V)	(%/°C)
		Min	Max				(Note 2)		
P6KE6.8	6.8	6.12	7.48	10	5.50	1000	58.0	10.8	0.057
P6KE6.8A	6.8	6.46	7.14	10	5.80	1000	60.0	10.5	0.057
P6KE7.5	7.5	6.75	8.25	10	6.05	500	53.0	11.7	0.061
P6KE7.5A	7.5	7.13	7.88	10	6.40	500	55.0	11.3	0.061
P6KE8.2	8.2	7.38	9.02	10	6.63	200	50.0	12.5	0.065
P6KE8.2A	8.2	7.79	8.61	10	7.02	200	52.0	12.1	0.065
P6KE9.1	9.1	8.19	10.00	1	7.37	50	45.0	13.8	0.068
P6KE9.1A	9.1	8.65	9.55	1	7.78	50	47.0	13.4	0.068
P6KE10	10	9.00	11.00	1	8.10	10	42.0	15.0	0.073
P6KE10A	10	9.50	10.5	1	8.55	10	43.0	14.5	0.073
P6KE11	11	9.90	12.1	1	8.92	1	38.0	16.2	0.075
P6KE11A	11	10.5	11.6	1	9.40	1	40.0	15.6	0.075
P6KE12	12	10.8	13.2	1	9.72	1	36.0	17.3	0.078
P6KE12A	12	11.4	12.6	1	10.2	1	37.0	16.7	0.078
P6KE13	13	11.7	14.3	1	10.5	1	33.0	19.0	0.081
P6KE13A	13	12.4	13.7	1	11.1	1	34.0	18.2	0.081
P6KE15	15	13.5	16.5	1	12.1	1	28.0	22.0	0.084
P6KE15A	15	14.3	15.8	1	12.8	1	29.0	21.2	0.084
P6KE16	16	14.4	17.6	1	12.9	1	26.0	23.5	0.086
P6KE16A	16	15.2	16.8	1	13.6	1	28.0	22.5	0.086
P6KE18	18	16.2	19.8	1	14.5	1	23.0	26.5	0.088
P6KE18A	18	17.1	18.9	1	15.3	1	25.0	25.5	0.088
P6KE20	20	18.0	22.0	1	16.2	1	21.0	29.1	0.090
P6KE20A	20	19.0	21.0	1	17.1	1	22.0	27.7	0.090
P6KE22	22	19.8	24.2	1	17.8	1	19.0	31.9	0.092
P6KE22A	22	20.9	23.1	1	18.8	1	20.0	30.6	0.092
P6KE24	24	21.6	26.4	1	19.4	1	18.0	34.7	0.094
P6KE24A	24	22.8	25.2	1	20.5	1	19.0	33.2	0.094
P6KE27	27	24.3	29.7	1	21.8	1	16.0	39.1	0.096
P6KE27A	27	25.7	28.4	1	23.1	1	16.8	37.5	0.096
P6KE30	30	27.0	33.0	1	24.3	1	14.0	43.5	0.097
P6KE30A	30	28.5	31.5	1	25.6	1	15.0	41.4	0.097
P6KE33	33	29.7	36.3	1	26.8	1	13.0	47.7	0.098
P6KE33A	33	31.4	34.7	1	28.2	1	13.8	45.7	0.098
P6KE36	36	32.4	39.6	1	29.1	1	12.0	52.0	0.099
P6KE36A	36	34.2	37.8	1	30.8	1	12.6	49.9	0.099
P6KE39	39	35.1	42.9	1	31.6	1	11.1	56.4	0.100
P6KE39A	39	37.1	41.0	1	33.3	1	11.6	53.9	0.100
P6KE43	43	38.7	47.3	1	34.8	1	10.0	61.9	0.101
P6KE43A	43	40.9	45.2	1	36.8	1	10.6	59.3	0.101
P6KE47	47	42.3	51.7	1	38.1	1	9.2	67.8	0.101
P6KE47A	47	44.7	49.4	1	40.2	1	9.7	64.8	0.101
P6KE51	51	45.9	56.1	1	41.3	1	8.5	73.5	0.102
P6KE51A	51	48.5	53.6	1	43.6	1	8.9	70.1	0.102
P6KE56	56	50.4	61.6	1	45.4	1	7.8	80.5	0.103
P6KE56A	56	53.2	58.8	1	47.8	1	8.1	77.0	0.103
P6KE62	62	55.8	68.2	1	50.2	1	7.0	89.0	0.104
P6KE62A	62	58.9	65.1	1	53.0	1	7.4	85.0	0.104

ELECTRICAL CHARACTERISTICS (TA=25°C unless otherwise noted)

General Part Number	Nominal Voltage	Breakdown Voltage (Note 1)		Test Current	Stand-Off Voltage	Maximum Reverse Leakage @ V_{WM}	Maximum Peak Surge Current	Maximum Clamping Voltage @ I_{PPM}	Maximum Temperature Coefficient
		V_{BR}		I_T	V_{WM}	I_D	I_{PPM}	V_C	of V_{BR}
	(V)	(V)		(mA)	(V)	(μ A)	(A)	(V)	(%/°C)
		Min	Max				(Note 2)		
P6KE68	68	61.2	74.8	1	55.1	1	6.4	98.0	0.104
P6KE68A	68	64.6	71.4	1	58.1	1	6.8	92.0	0.104
P6KE75	75	67.5	82.5	1	60.7	1	5.8	108	0.105
P6KE75A	75	71.3	78.8	1	64.1	1	6.1	103	0.105
P6KE82	82	73.8	90.2	1	66.4	1	5.3	118	0.105
P6KE82A	82	77.9	86.1	1	70.1	1	5.5	113	0.105
P6KE91	91	81.9	100	1	73.7	1	4.8	131	0.106
P6KE91A	91	86.5	95.5	1	77.8	1	5.0	125	0.106
P6KE100	100	90	110	1	81.0	1	4.3	144	0.106
P6KE100A	100	95	105	1	85.5	1	4.5	137	0.106
P6KE110	110	99	121	1	89.2	1	3.9	158	0.107
P6KE110A	110	105	116	1	94.0	1	4.1	152	0.107
P6KE120	120	108	132	1	97.2	1	3.6	173	0.107
P6KE120A	120	114	126	1	102	1	3.8	165	0.107
P6KE130	130	117	143	1	105	1	3.3	187	0.107
P6KE130A	130	124	137	1	111	1	3.5	179	0.107
P6KE150	150	135	165	1	121	1	2.9	215	0.108
P6KE150A	150	143	158	1	128	1	3.0	207	0.108
P6KE160	160	144	176	1	130	1	2.7	230	0.108
P6KE160A	160	152	168	1	136	1	2.8	219	0.108
P6KE170	170	153	187	1	138	1	2.5	244	0.108
P6KE170A	170	162	179	1	145	1	2.6	234	0.108
P6KE180	180	162	198	1	146	1	2.4	258	0.108
P6KE180A	180	171	189	1	154	1	2.5	246	0.108
P6KE200	200	180	220	1	162	1	2.1	287	0.108
P6KE200A	200	190	210	1	171	1	2.2	274	0.108
P6KE220	220	198	242	1	175	1	1.8	344	0.108
P6KE220A	220	209	231	1	185	1	1.9	328	0.108
P6KE250	250	225	275	1	202	1	1.7	360	0.110
P6KE250A	250	237	263	1	214	1	1.8	344	0.110
P6KE300	300	270	330	1	243	1	1.4	430	0.110
P6KE300A	300	285	315	1	256	1	1.5	414	0.110
P6KE350	350	315	385	1	284	1	1.2	504	0.110
P6KE350A	350	332	368	1	300	1	1.3	482	0.110
P6KE400	400	360	440	1	324	1	1.0	574	0.110
P6KE400A	400	380	420	1	342	1	1.1	548	0.110
P6KE440	440	396	484	1	356	1	1.0	631	0.110
P6KE440A	440	418	462	1	376	1	1.04	602	0.110

Notes:

- V_{BR} measure after I_T applied for 300 μ s, I_T =square wave pulse or equivalent.
- Surge current waveform per Figure. 3 and derate per Figure. 2.
- For bipolar types having V_{WM} of 10 volts and under, the I_D limit is doubled.
- All terms and symbols are consistent with ANSI/IEEE C62.35.

Ordering information

Part No.	Package	Packing	INNER TAPE	Packing code	Packing code (Green)
P6KExx (Note)	DO-15	1.5K / AMMO box	52mm	A0	A0G
	DO-15	3.5K / 13" Reel	52mm	R0	R0G
	DO-15	1K / Bulk packing		B0	B0G

Note: "x" is Device Code from "6.8" thru "440A".

AXIAL LEAD TAPING SPECIFICATIONS

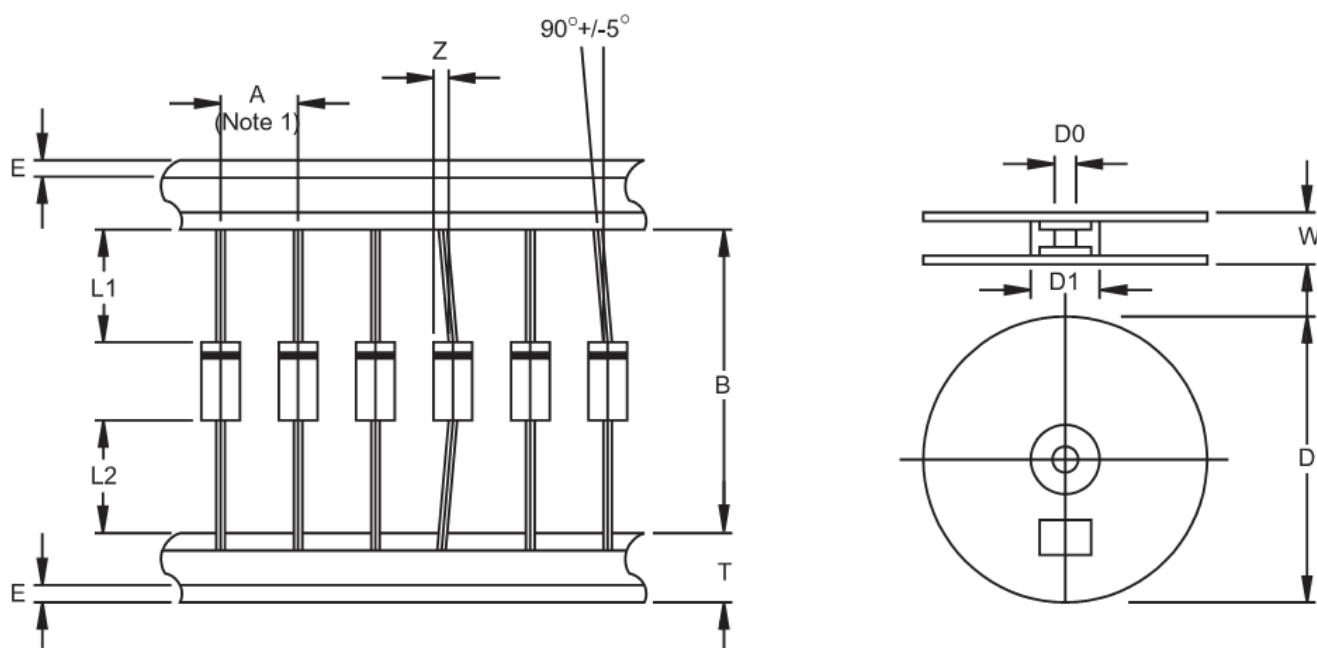

Outline	A	B	Z	T	E	L1-L2	D	D1	D0	W
		± 0.5	± 1.5	MAX	± 0.4	MAX	MAX		± 0.3	± 0.4
DO-15	5	52.4	1.2	6	0.8	1	330	85.7	16.6	76

Unit (mm)

Suggested Mounting Hole Rule

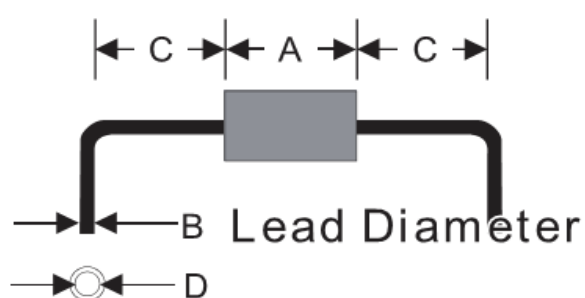

Symbol	Unit(mm)
A	6.4
B	0.8
C	3.0
D	1.2

Dimensions

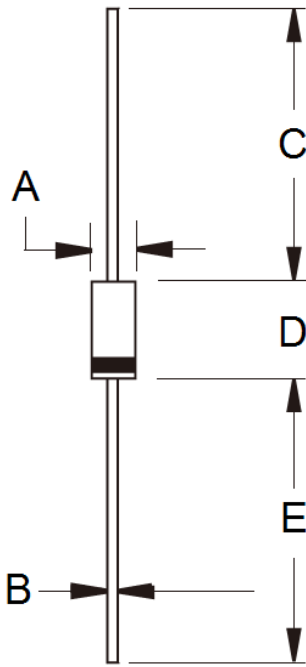

DIM.	Unit(mm)		Unit(inch)	
	Min	Max	Min	Max
A	2.60	3.60	0.102	0.142
B	0.70	0.90	0.028	0.035
C	25.40	-	1.000	-
D	5.80	7.60	0.228	0.299
E	25.40	-	1.000	-

Marking Diagram



- P/N = Specific Device Code
- G = Green Compound
- YWW = Date Code
- F = Factory Code