

Features

- ✧ Plastic package has Underwriters Laboratory Flammability Classification 94V-0
- ✧ Exceeds environmental standards of MIL-STD-19500
- ✧ 600W surge capability at 10 x 1000 us waveform
- ✧ Excellent clamping capability
- ✧ Low Dynamic impedance
- ✧ Fast response time: Typically less than 1.0ps from 0 volt to VBR for unidirectional and 5.0 ns for bidirectional
- ✧ Typical I_R less than 1uA above 10V
- ✧ High temperature soldering guaranteed: 260°C / 10 seconds
- ✧ Green compound with suffix "G" on packing code & prefix "G" on datecode

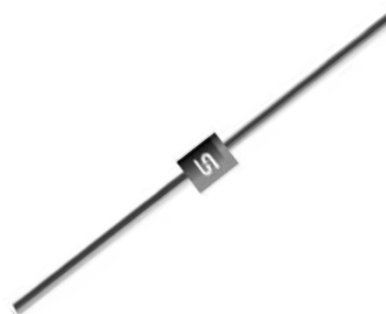

Mechanical Data

- ✧ Case: Molded plastic
- ✧ Lead: Axial leads, solderable per MIL-STD-202, Method 208
- ✧ Polarity: Color band denotes cathode except bipolar
- ✧ Weight: 0.354 gram

Ordering Information (example)

Part No.	Package	Packing	INNER TAPE	Packing code	Packing code (Green)
BZW06-13	DO-15	1.5K / AMMO box	52mm	A0	A0G

Maximum Ratings and Electrical Characteristics

Rating at 25 °C ambient temperature unless otherwise specified.

Type Number	Symbol	Value	Unit
Peak Pulse Power Dissipation at $T_A=25^\circ\text{C}$, $T_p=1\text{ms}$ (Note 1)	P_{PK}	Minimum 600	Watts
Steady State Power Dissipation at $T_L=75^\circ\text{C}$ Lead Lengths .375", 9.5mm	P_D	1.7	Watts
Peak Forward Surge Current, 8.3ms Single Half Sine-wave Superimposed on Rated Load (JEDEC method)	I_{FSM}	100	Amps
Junction to leads	$R_{\theta JL}$	60	°C/W
Junction to ambient on printed circuit L lead=10mm	$R_{\theta JA}$	100	°C/W
Operating and Storage Temperature Range	T_J, T_{STG}	-55 to +175	°C

Note 1: Non-repetitive Current Pulse, Per Fig. 3

RATINGS AND CHARACTERISTIC CURVES (BZW06 SERIES)

FIG. 1 PEAK PULSE POWER RATING CURVE

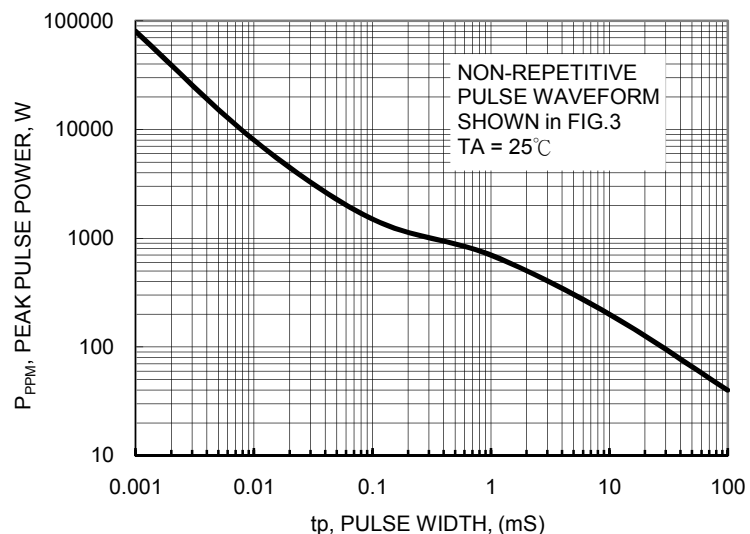

FIG.2 PULSE DERATING CURVE

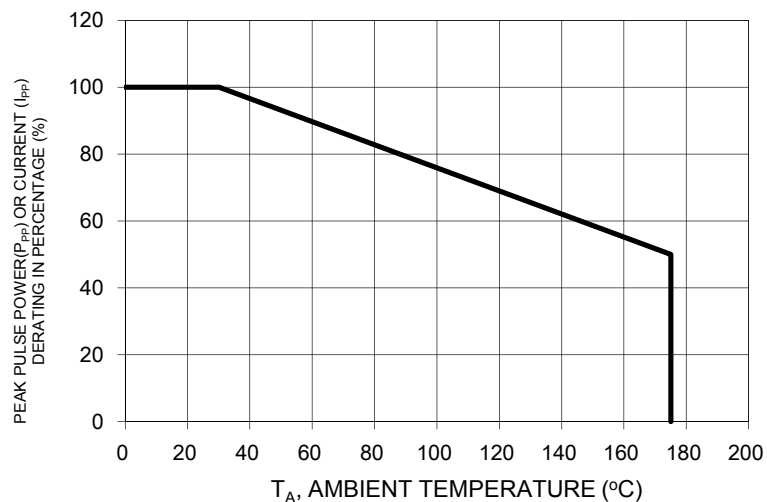

FIG. 3 CLAMPING POWER PULSE WAVEFORM

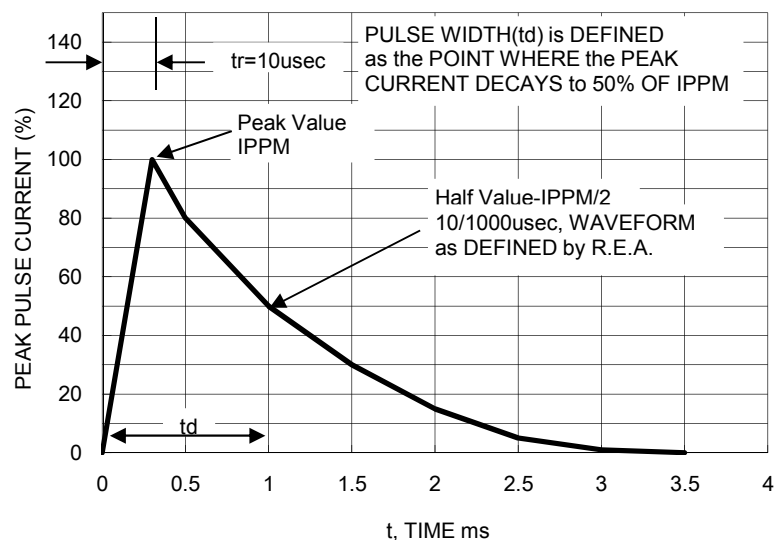

FIG. 4 CLAMPING VOLTAGE CURVE

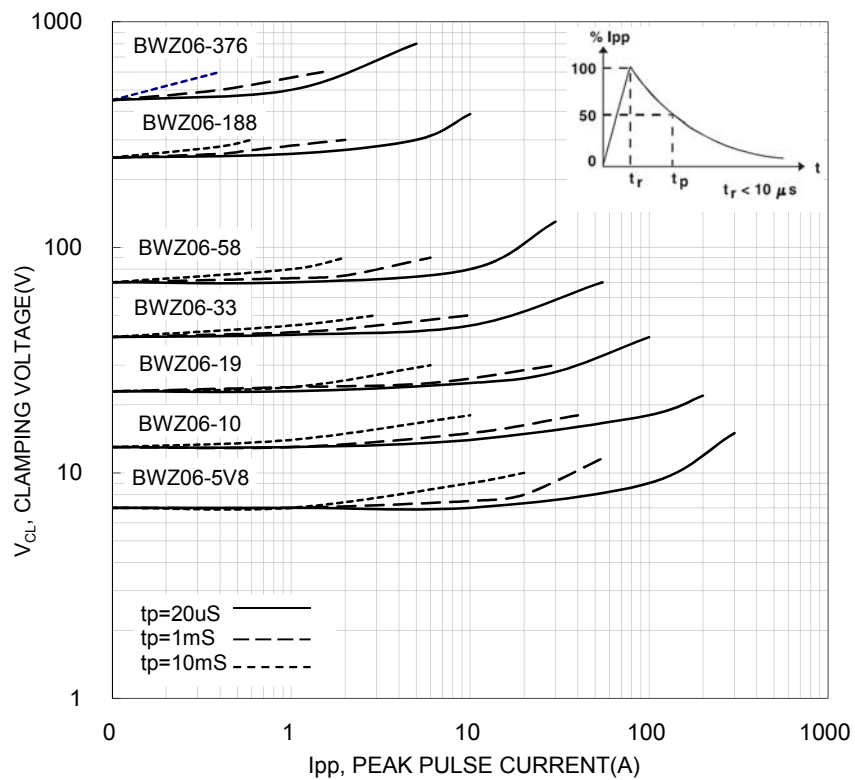
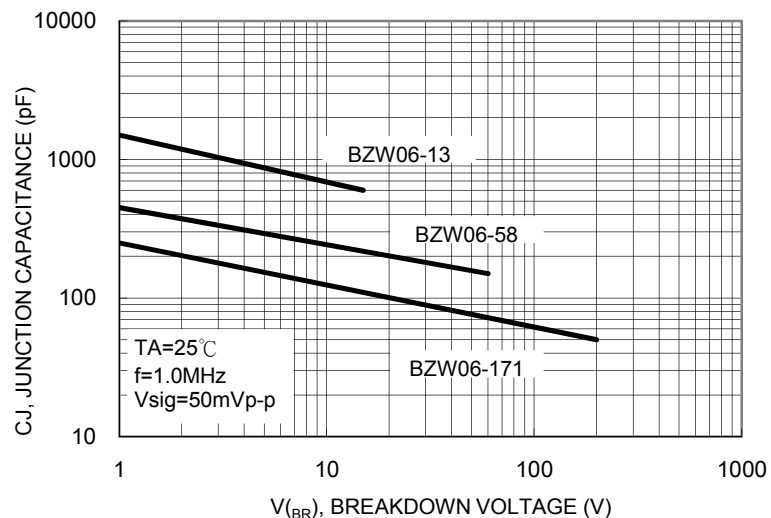

FIG. 5 TYPICAL JUNCTION CAPACITANCE



RATINGS AND CHARACTERISTIC CURVES (BZW06 SERIES)

FIG. 6 TYPICAL JUNCTION CAPACITANCE

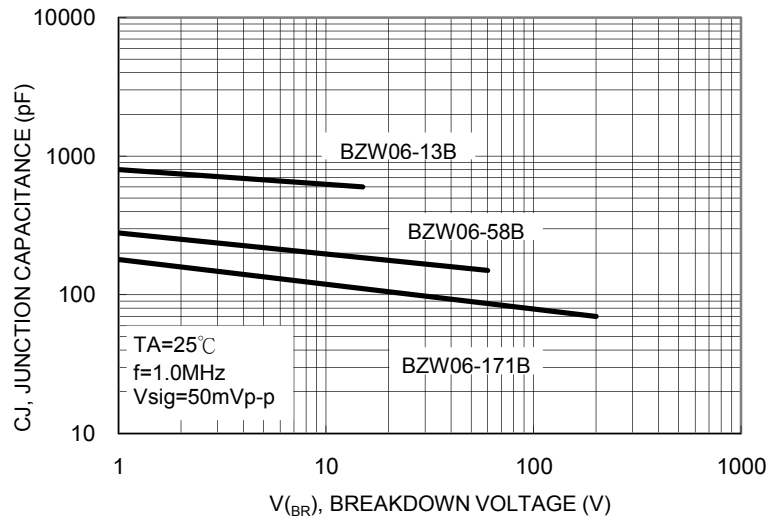

FIG.7 TYPICAL FORWARD CHARACTERISTICS UNIDIRECTIONAL TYPE

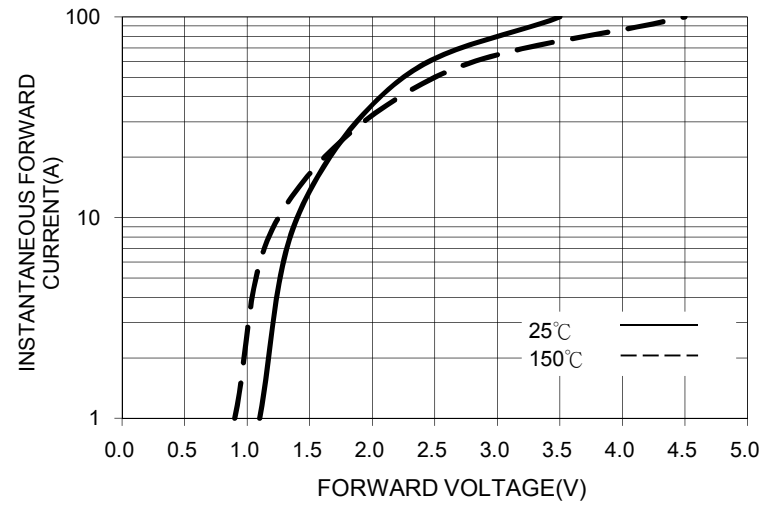

FIG. 8 TYPICAL TRANSIENT THERMAL CHARACTERISTICS

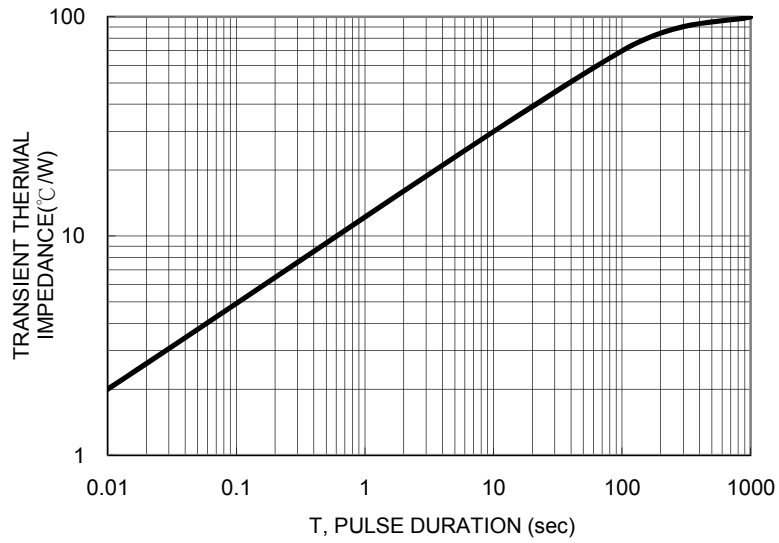
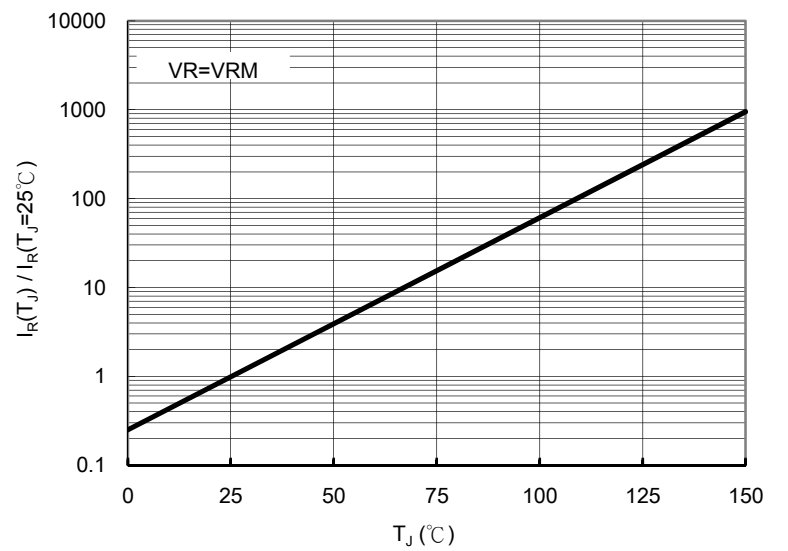

FIG. 9 RELATIVE VARIATION OF LEAKAGE CURRENT vs JUNCTION TEMPERATURE



ELECTRICAL CHARACTERISTICS (T_A=25°C unless otherwise noted)

Device		Breakdown Voltage (Note 1)			Test Current	Stand-Off Voltage	Reverse Leakage @ V _{WM}	Clamping Voltage @ I _{PPM} (10/1000 us)		Clamping Voltage @ I _{PPM} (8/20 us)		Maximum Temperature Coefficient
		V _{BR}						I _T	V _{WM}	I _D	V _C	
		Min	Nom	Max	mA	V	uA	V	A	V	A	%/°C
Unidirectional	Bidirectional						Max	Max		Max		(Note 2)
BZW06-13	BZW06-13B	14.3	15	15.8	1	12.8	5	21.2	28.0	27.2	147	0.084
BZW06-15	BZW06-15B	17.1	18	18.9	1	15.3	1	25.2	24.0	32.5	123	0.088
BZW06-19	BZW06-19B	20.9	22	23.1	1	18.8	1	30.6	19.6	39.3	102	0.092
BZW06-20	BZW06-20B	22.8	24	25.2	1	20.5	1	33.2	28.0	42.8	93	0.094
BZW06-23	BZW06-23B	25.7	27	28.4	1	23.1	1	37.5	16.0	48.3	83	0.096
BZW06-26	BZW06-26B	28.5	30	31.5	1	25.6	1	41.5	14.5	53.5	75	0.097
BZW06-28	BZW06-28B	31.4	33	34.7	1	28.2	1	45.7	13.1	59.0	68	0.098
BZW06-31	BZW06-31B	34.2	36	37.8	1	30.8	1	49.9	12.0	64.3	62	0.099
BZW06-33	BZW06-33B	37.1	39	47.0	1	33.3	1	53.9	11.1	69.7	57	0.100
BZW06-37	BZW06-37B	40.9	43	45.2	1	36.8	1	59.3	10.1	75.0	52	0.101
BZW06-40	BZW06-40B	44.7	47	49.4	1	40.2	1	64.8	9.3	84.0	48	0.101
BZW06-48	BZW06-48B	53.2	56	58.8	1	47.8	1	77.0	7.8	100	40	0.103
BZW06-58	BZW06-58B	64.6	68	71.4	1	58.1	1	92.0	6.5	121	33	0.104
BZW06-70	BZW06-70B	77.9	82	86.1	1	70.1	1	113	5.3	146	27	0.105
BZW06-85	BZW06-85B	95	100	105	1	85.5	1	137	4.4	178	23	0.106
BZW06-102	BZW06-102B	114	120	126	1	102	1	165	3.6	212	19	0.107
BZW06-128	BZW06-128B	143	150	158	1	128	1	207	2.9	265	15	0.108
BZW06-154	BZW06-154B	171	180	189	1	154	1	246	2.4	317	13	0.108
BZW06-171	BZW06-171B	190	200	210	1	171	1	274	2.2	353	11	0.108
BZW06-188	BZW06-188B	209	220	231	1	188	1	301	2.0	388	10.3	0.108
BZW06-213	BZW06-213B	237	250	263	1	213	1	344	2.0	442	9.0	0.110
BZW06-256	BZW06-256B	285	300	315	1	256	1	414	1.6	529	7.6	0.110
BZW06-273	BZW06-273B	304	320.0	336	1	273	1	438	1.6	564	7.1	0.110
BZW06-299	BZW06-299B	332	350.0	368	1	299	1	482	1.6	618	6.5	0.110
BZW06-342	BZW06-342B	380	400	420	1	342	1	548	1.3	706	5.7	0.110
BZW06-376	BZW06-376B	418	440	462	1	376	1	603	1.3	776	5.7	0.110

Notes:

- Pulse test : tp<50ms
- $\Delta V_{BR} = \alpha T * (T_{amb} - 25) * V_{BR}(25^{\circ}C)$
- V_R=0V, F=1MHz, For bidirectional types, capacitance value is divided by 2.

Ordering information

Part No.	Package	Packing	INNER TAPE	Packing code	Packing code (Green)
BZW06-xx (Note)	DO-15	1.5K / AMMO box	52mm	A0	A0G
	DO-15	3.5K / 13" Reel	52mm	R0	R0G
	DO-15	1K / Bulk packing		B0	B0G

Note: "x" is Device Code from "13" thru "376B".

AXIAL LEAD TAPING SPECIFICATIONS

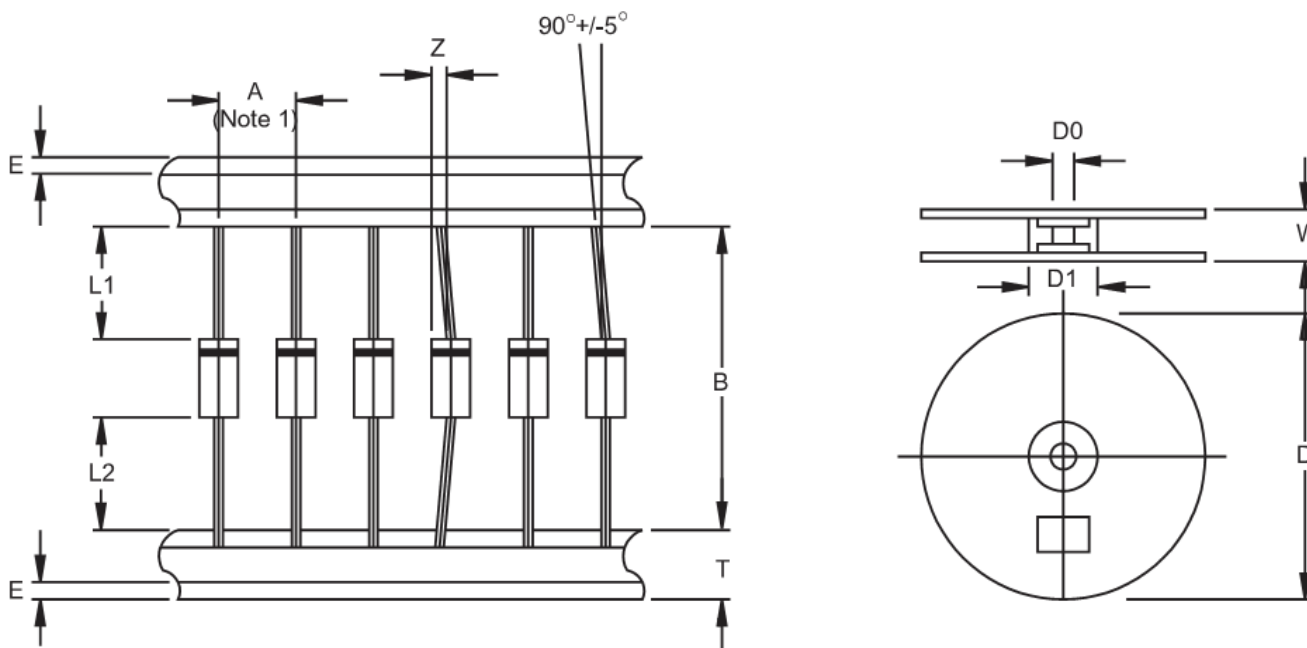

Outline	A	B	Z	T	E	L1-L2	D	D1	D0	W
	±0.5	±1.5	MAX	±0.4	MAX	MAX		±0.3	±0.4	±1.0
DO-15	5	52.4	1.2	6	0.8	1	330	85.7	16.6	76

Unit (mm)

Suggested Mounting Hole Rule

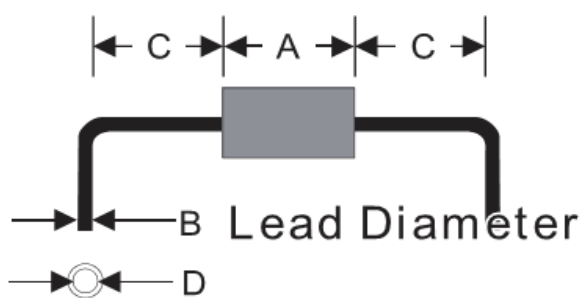

Symbol	Unit(mm)
A	6.4
B	0.8
C	3.0
D	1.2

Dimensions

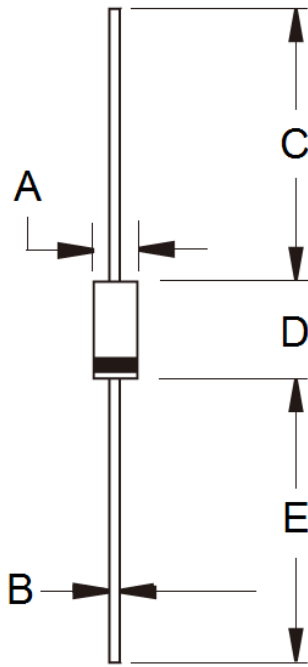

DIM.	Unit(mm)		Unit(inch)	
	Min	Max	Min	Max
A	2.60	3.60	0.102	0.142
B	0.70	0.90	0.028	0.035
C	25.40	-	1.000	-
D	5.80	7.60	0.228	0.299
E	25.40	-	1.000	-

Marking Diagram



- P/N = Specific Device Code
- G = Green Compound
- YWW = Date Code
- F = Factory Code