

### Small Signal Diode



#### Features

- ✧ Epitaxial planar die construction
- ✧ Surface device type mounting
- ✧ Moisture sensitivity level 1
- ✧ Matte tin (Sn) lead finish with Nickel (Ni) underplate
- ✧ Pb-free version and RoHS compliant
- ✧ Green compound (Halogen free) with suffix "G" on packing code and prefix "G" on date code.

#### Mechanical Data

- ✧ Case : SOT- 23 small outline plastic package
- ✧ Terminal: Matte tin plated, lead free, solderable per MIL-STD-202, Method 208 guaranteed
- ✧ High temperature soldering guaranteed: 260°C/10s
- ✧ Weight: 0.008 grams (approximate)
- ✧ Marking: D3Q

#### Ordering Information

Part No.	Packing Code	Package	Packing	Marking
RB495D	RF	SOT-23	3K / 7" Reel	D3Q
RB495D	RFG	SOT-23	3K / 7" Reel	D3Q

#### Maximum Ratings

Rating at 25°C ambient temperature unless otherwise specified.

#### Maximum Ratings

Type Number	Symbol	Value	Units
Power dissipation	$P_D$	200	mW
Repetitive Peak Reverse Voltage	$V_{RRM}$	40	V
Reverse Voltage	$V_R$	25	V
Mean Forward Current	$I_o$	350	mA
Non-Repetitive Peak Forward Surge Current ( Note 1)	$I_{FSM}$	1.5	A
Junction Temperature	$T_J$	125	°C
Storage Temperature Range	$T_{STG}$	-40 ~ +125	°C

Note 1: Mean output current per element:  $I_o/2$ .

Note 2: The suggested land pattern dimensions have been provided for reference only, as actual pad layouts may vary depending on application.

#### SOT-23

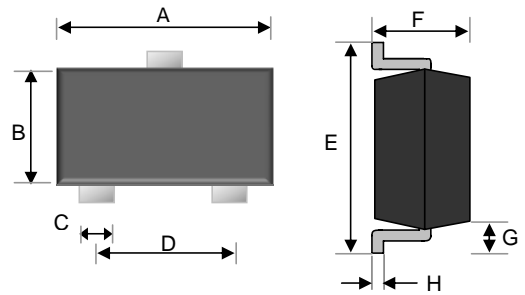

Dimensions	Unit (mm)		Unit (inch)	
	Min	Max	Min	Max
A	2.80	3.00	0.110	0.118
B	1.20	1.40	0.047	0.055
C	0.30	0.50	0.012	0.020
D	1.80	2.00	0.071	0.079
E	2.25	2.55	0.089	0.100
F	0.90	1.20	0.035	0.047
G	0.550 REF		0.022 REF	
H	0.08	0.19	0.003	0.010

#### Suggested PAD Layout

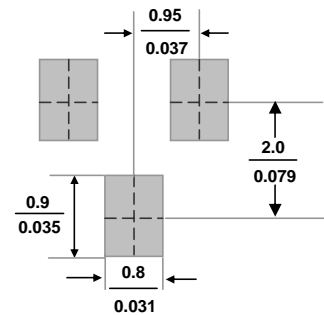

**Small Signal Diode**

**Electrical Characteristics**

Type Number		Symbol	Min	Max	Units
Reverse Breakdown Voltage	$I_R = 100\mu A$	$V_{(BR)}$	40	-	V
Forward Voltage	$I_F = 10mA$	$V_F$	-	0.32	V
	$I_F = 200mA$		-	0.55	
Reverse Leakage Current	$V_R = 25V$	$I_R$	-	70	$\mu A$
Junction Capacitance	$V_R = 0, f = 1.0MHz$	$C_J$	-	50.0	pF

**Carrier & Reel specification**

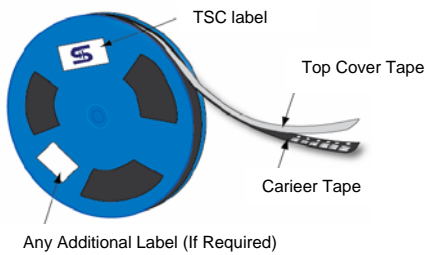

Item	Symbol	Dimension(mm)
Carrier depth	K	2.40 Max.
Sprocket hole	D	1.50 ±0.10
Reel outside diameter	A	178 ± 1
Reel inner diameter	D1	50 Min.
Feed hole width	D2	13.0 ± 0.5
Sprocket hole position	E	1.75 ±0.10
Punch hole position	F	3.50 ±0.05
Sprocket hole pitch	P0	4.00 ±0.10
Embossment center	P1	2.00 ±0.10
Overall tape thickness	T	0.6 Max.
Tape width	W	8.30 Max.
Reel width	W1	14.4 Max.

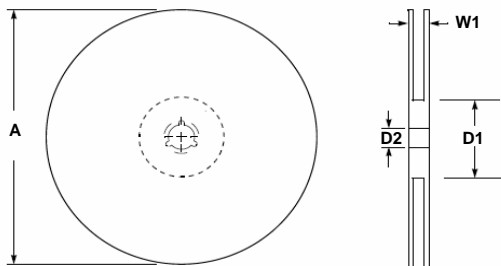
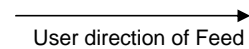
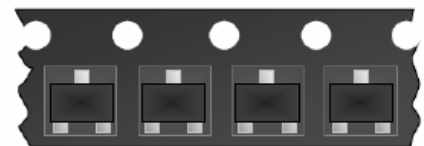
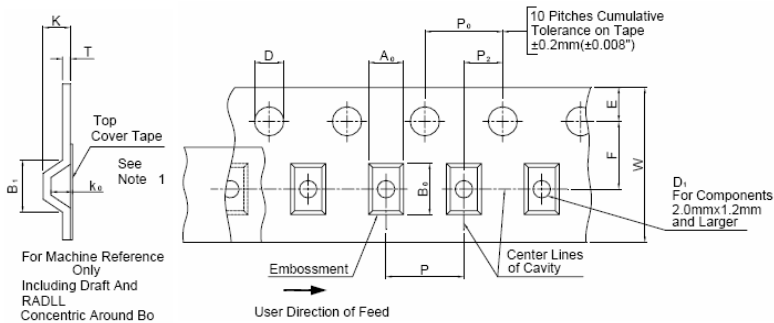

Note 1: A0, B0, and K0 are determined by component size. The clearance between the components and the cavity must be within 0.05 mm min. to 0.5 mm max. The component cannot rotate more than 10° within the determined cavity.

Note 2: If B1 exceeds 4.2 mm(0.165") for 8 mm embossed tape, the tape may not feed through all tape feeders.

**Small Signal Diode**

**Rating and Characteristic Curves**

**FIG 1 Typical Forward Characteristics**

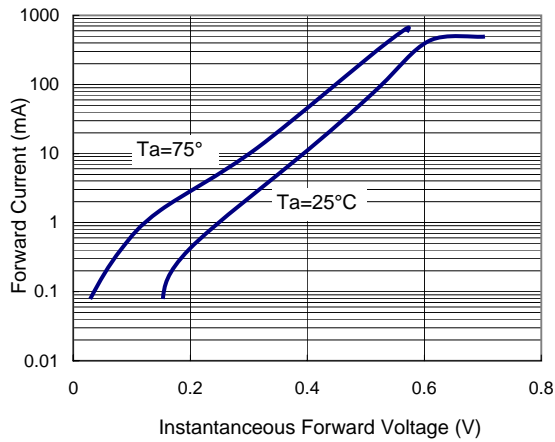

**FIG 2 Reverse Current vs Reverse Voltage**

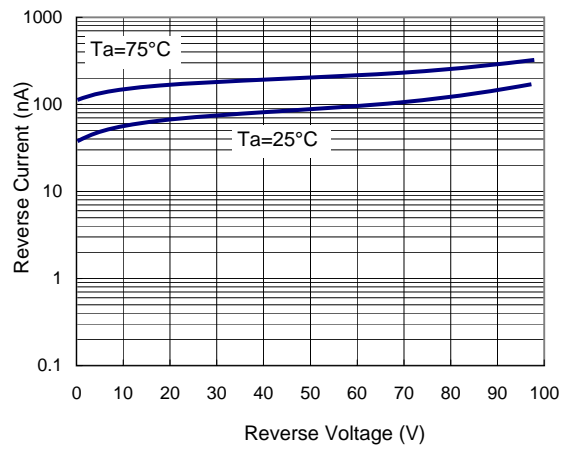

**FIG 3 Admissible Power Dissipation Curve**

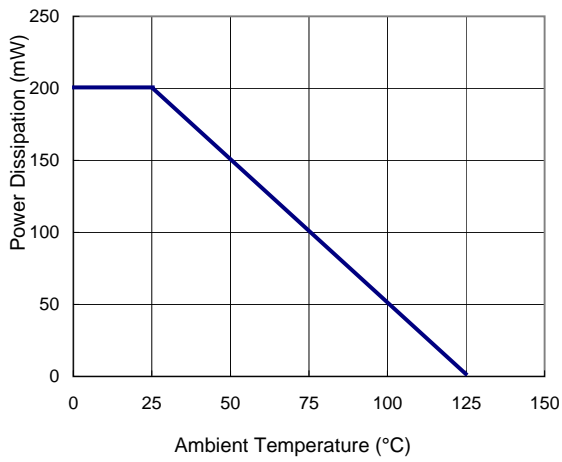

**FIG 4 Typical Junction Capacitance**

