

### Features

- ✧ Glass passivated chip junction
- ✧ High current capability, Low VF
- ✧ High reliability
- ✧ High surge current capability
- ✧ Low power loss, high efficiency
- ✧ Green compound with suffix "G" on packing code & prefix "G" on datecode



### Mechanical Data

- ✧ Case: Molded plastic DO-41
- ✧ Epoxy: UL 94V-0 rate flame retardant
- ✧ Lead: Pure tin plated, lead free, solderable per MIL-STD-202, Method 208 guaranteed
- ✧ Polarity: Color band denotes cathode
- ✧ High temperature soldering guaranteed: 260°C/10s / .375", (9.5mm) lead lengths at 5 lbs, (2.3kg) tension
- ✧ Weight: 0.34 grams

### Ordering Information (example)

Part No.	Package	Packing	INNER TAPE	Packing code	Packing code (Green)
1N4001G	DO-41	3K / AMMO box	52mm	A0	A0G

### Maximum Ratings and Electrical Characteristics

Rating at 25 °C ambient temperature unless otherwise specified.

Single phase, half wave, 60 Hz, resistive or inductive load.

For capacitive load, derate current by 20%

Type Number	Symbol	1N	1N	1N	1N	1N	1N	1N	Unit
		4001G	4002G	4003G	4004G	4005G	4006G	4007G	
Maximum Repetitive Peak Reverse Voltage	$V_{RRM}$	50	100	200	400	600	800	1000	V
Maximum RMS Voltage	$V_{RMS}$	35	70	140	280	420	560	700	V
Maximum DC Blocking Voltage	$V_{DC}$	50	100	200	400	600	800	1000	V
Maximum Average Forward Rectified Current	$I_{F(AV)}$	1							A
Peak Forward Surge Current, 8.3 ms Single Half Sine-wave Superimposed on Rated Load (JEDEC method)	$I_{FSM}$	30							A
Maximum Instantaneous Forward Voltage (Note 1) @ 1 A	$V_F$	1.0							V
Maximum Reverse Current @ Rated VR $T_A=25^\circ\text{C}$ $T_A=125^\circ\text{C}$	$I_R$	5 100							uA
Typical Junction Capacitance (Note 2)	$C_j$	10							pF
Typical Thermal Resistance	$R_{\theta JA}$	80							°C/W
Operating Temperature Range	$T_J$	- 65 to + 150							°C
Storage Temperature Range	$T_{STG}$	- 65 to + 150							°C

Note1: Pulse Test with PW=300 usec, 1% Duty Cycle

Note2: Measured at 1 MHz and Applied Reverse Voltage of 4.0V D.C.

RATINGS AND CHARACTERISTIC CURVES (1N4001G THRU 1N4007G)

FIG.1 MAXMUM FORWARD CURRENT DERATING CURVE

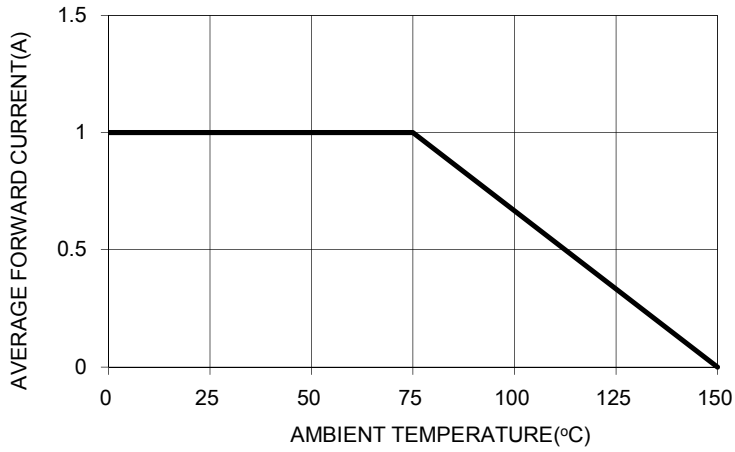

FIG. 2 MAXIMUM NON-REPETITIVE FORWARD SURGE CURRENT

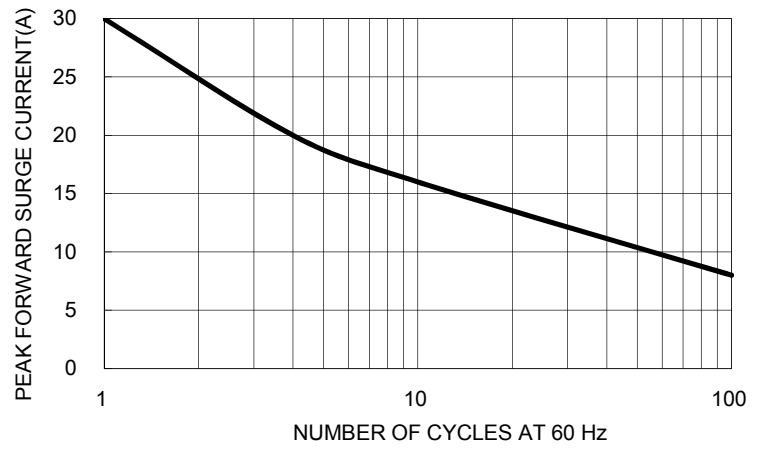

FIG. 3 TYPICAL FORWARD CHARACTERISTICS

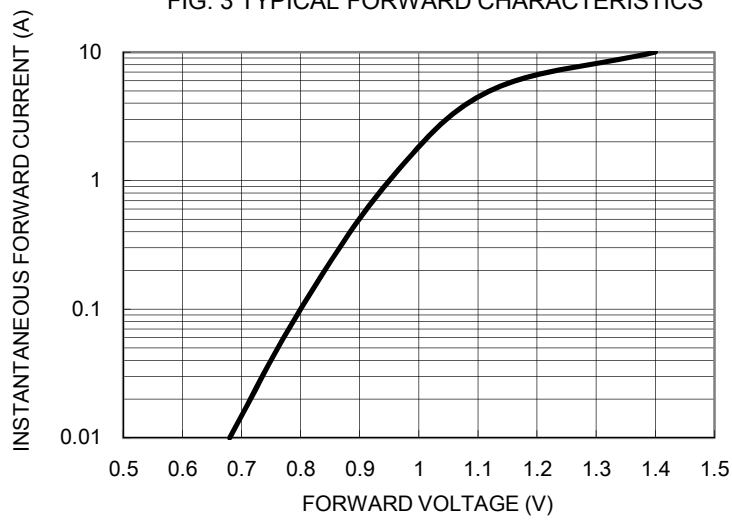

FIG. 4 TYPICAL REVERSE CHARACTERISTICS

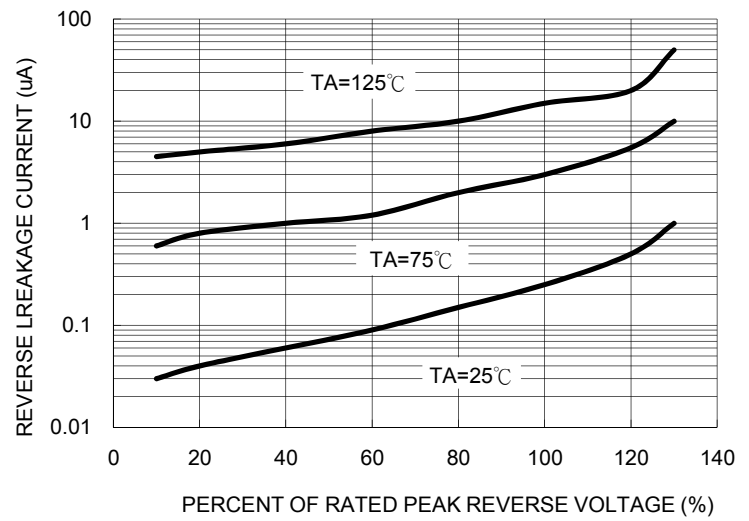
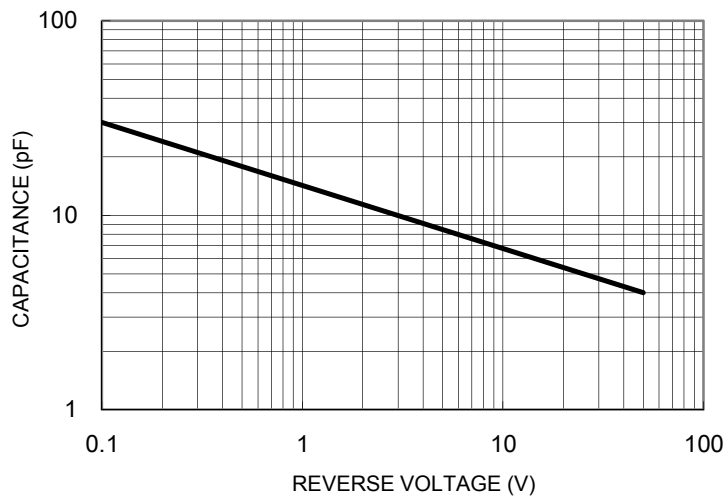

FIG. 5 TYPICAL JUNCTION CAPACITANCE



**Ordering information**

Part No.	Package	Packing	INNER TAPE	Packing code	Packing code (Green)
1N400xG	DO-41	3K / AMMO box	52mm	A0	A0G
	DO-41	3K / AMMO box	26mm	A1	A1G
	DO-41	5K / 13" Reel	52mm	R0	R0G
	DO-41	5K / 13" Reel	52mm	R1	R1G
	DO-41	1K / Bulk packing		B0	B0G

Note: "x" is Device Code from "1" thru "7".

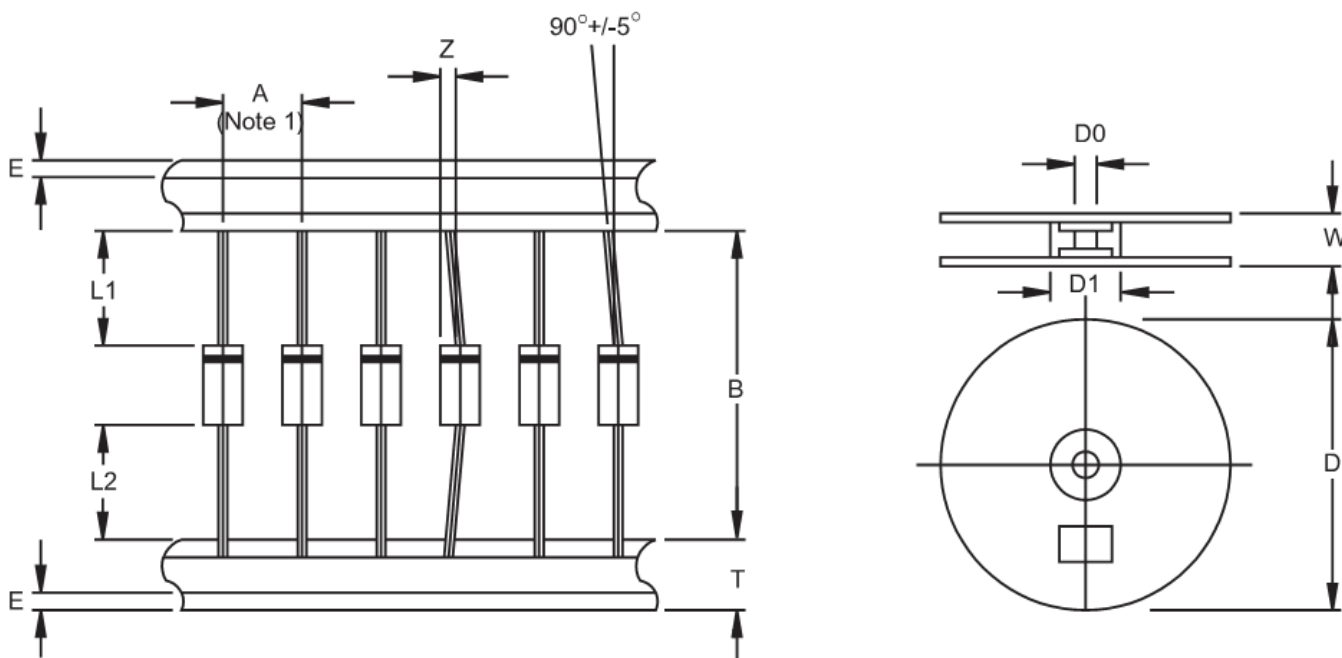
**AXIAL LEAD TAPING SPECIFICATIONS**

Outline	A	B	Z	T	E	L1-L2	D	D1	D0	W
		±0.5	±1.5	MAX	±0.4	MAX	MAX		±0.3	±0.4
DO-41	5	26	1.2	6	0.8	1	330	85.7	16.6	76
DO-41	5	52.4	1.2	6	0.8	1	330	85.7	16.6	76

Unit (mm)

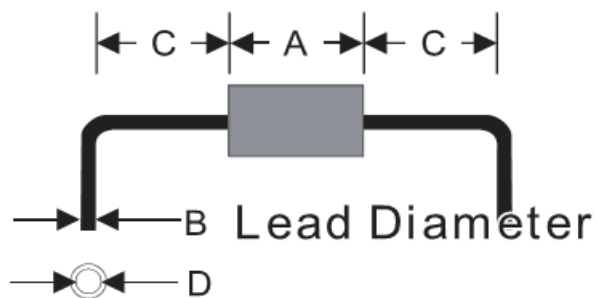
**Suggested Mounting Hole Rule**

Symbol	Unit(mm)
A	5.1
B	0.8
C	3.0
D	1.2

**Dimensions**

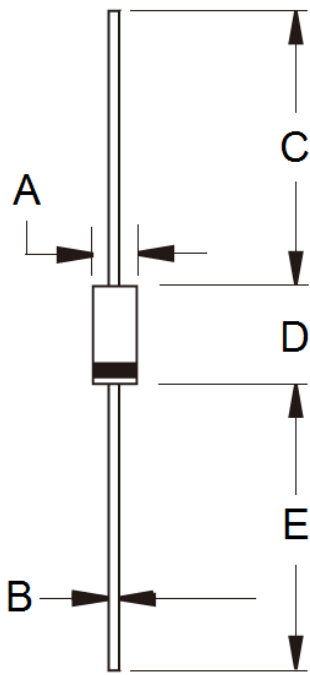

DIM.	Unit(mm)		Unit(inch)	
	Min	Max	Min	Max
A	2.00	2.70	0.079	0.106
B	0.71	0.86	0.028	0.034
C	25.40	-	1.000	-
D	4.20	5.20	0.165	0.205
E	25.40	-	1.000	-

**Marking Diagram**



- P/N = Specific Device Code
- G = Green Compound
- YWW = Date Code