

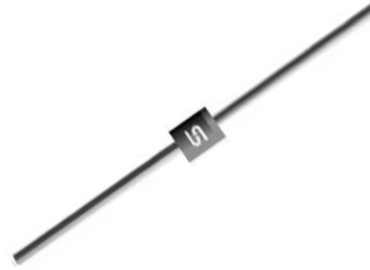

### Features

- ◇ High efficiency, Low VF
- ◇ High current capability
- ◇ High reliability
- ◇ High surge current capability
- ◇ Low power loss
- ◇ Green compound with suffix "G" on packing code & prefix "G" on datecode



### Mechanical Data

- ◇ Cases: Molded plastic
- ◇ Epoxy: UL 94V-0 rate flame retardant
- ◇ Lead: Pure tin plated, lead free, solderable per MIL-STD-202, Method 208 guaranteed
- ◇ Polarity: Color band denotes cathode end
- ◇ High temperature soldering guaranteed: 260°C/10s
- ◇ Weight: 0.34 grams

### Ordering Information (example)

Part No.	Package	Packing	INNER TAPE	Packing code	Packing code (Green)
FR101	DO-41	3K / AMMO box	52mm	A0	A0G

### Maximum Ratings and Electrical Characteristics

Rating at 25 °C ambient temperature unless otherwise specified.

Parameter	Symbol	FR 101	FR 102	FR 103	FR 104	FR 105	FR 106	FR 107	Units
Maximum Recurrent Peak Reverse Voltage	$V_{RRM}$	50	100	200	400	600	800	1000	V
Maximum RMS Voltage	$V_{RMS}$	35	70	140	280	420	560	700	V
Maximum DC Blocking Voltage	$V_{DC}$	50	100	200	400	600	800	1000	V
Maximum Average Forward Rectified Current	$I_{F(AV)}$	1							A
Peak Forward Surge Current, 8.3 ms Single Half Sine-wave Superimposed on Rated Load (JEDEC method)	$I_{FSM}$	30							A
Maximum Instantaneous Forward Voltage (Note 1) @ 1 A	$V_F$	1.2							V
Maximum DC Reverse Current at @ $T_A=25\text{ }^\circ\text{C}$	$I_R$	5							uA
Rated DC Blocking Voltage @ $T_A=125\text{ }^\circ\text{C}$		150							uA
Maximum Reverse Recovery Time (Note 2)	$T_{rr}$	150			250	500		nS	
Typical Junction Capacitance (Note 3)	$C_j$	10							pF
Typical Thermal Resistance	$R_{\theta JA}$ $R_{\theta JC}$	65 8							$^\circ\text{C/W}$
Operating Temperature Range $T_J$	$T_J$	- 55 to + 150							$^\circ\text{C}$
Storage Temperature Range $T_{STG}$	$T_{STG}$	- 55 to + 150							$^\circ\text{C}$

Note 1: Pulse Test with PW=300 usec, 1% Duty Cycle

Note 2: Reverse Recovery Test Conditions:  $I_F=0.5A$ ,  $I_R=1.0A$ ,  $I_{RR}=0.25A$

Note 3: Measured at 1 MHz and Applied Reverse Voltage of 4.0Volts D.C.

RATINGS AND CHARACTERISTIC CURVES (FR101 THRU FR107)

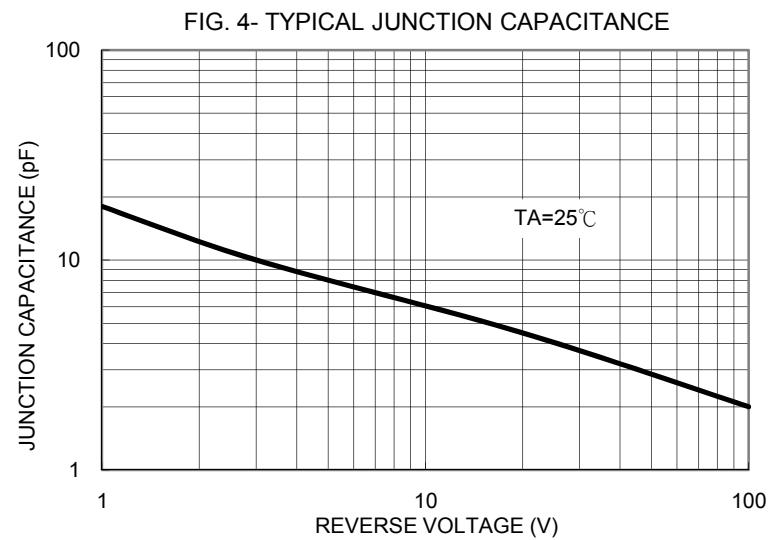
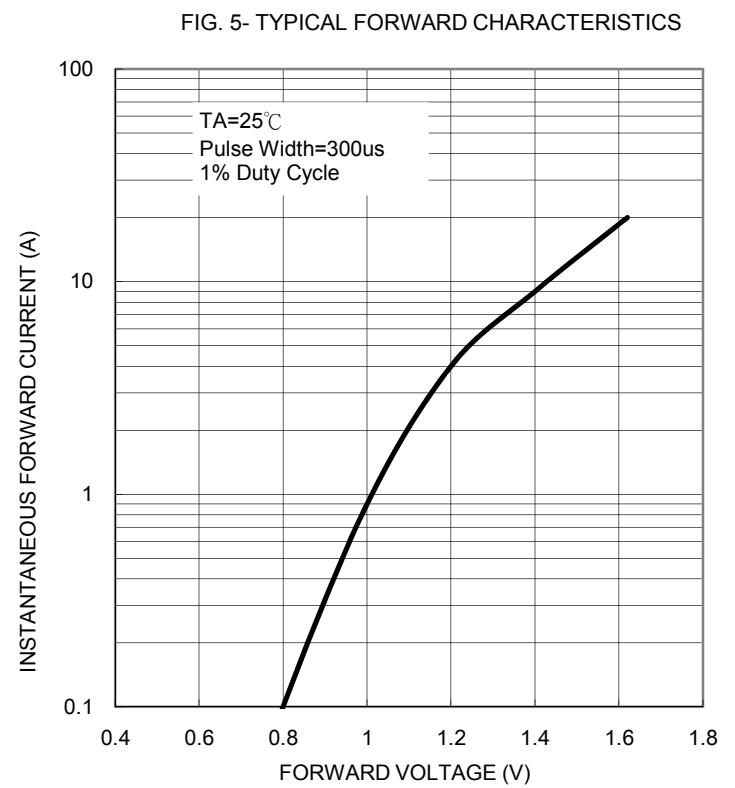
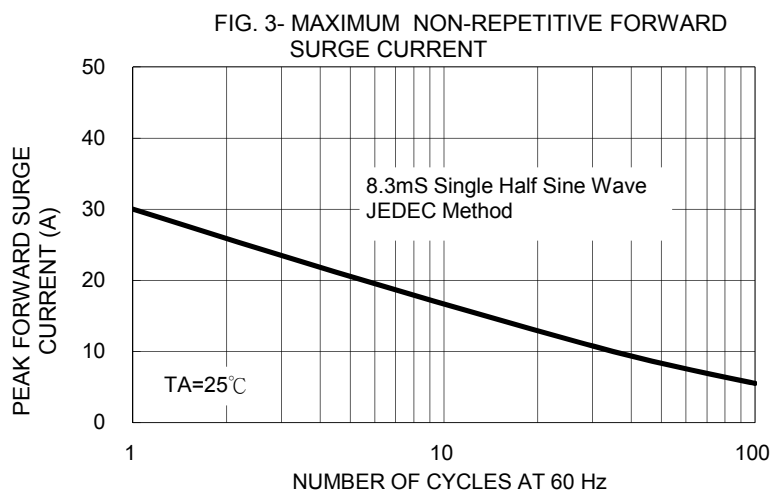
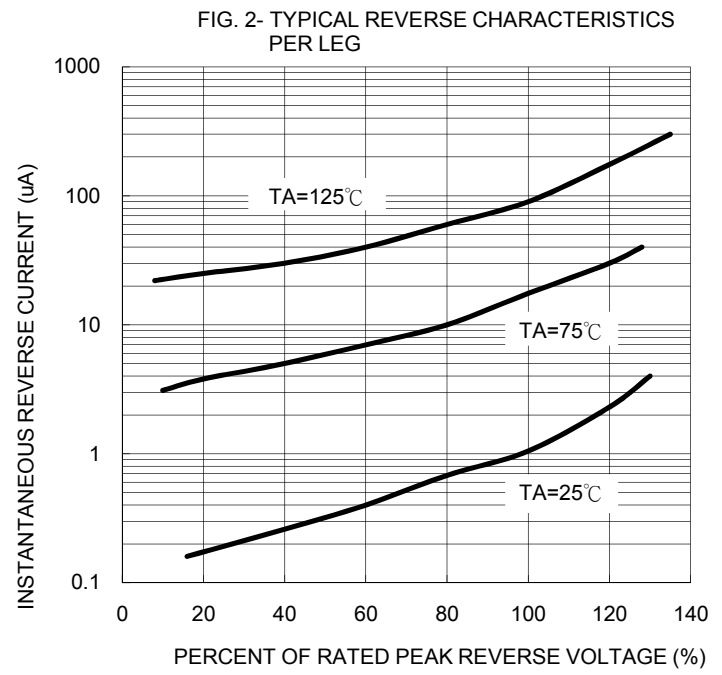
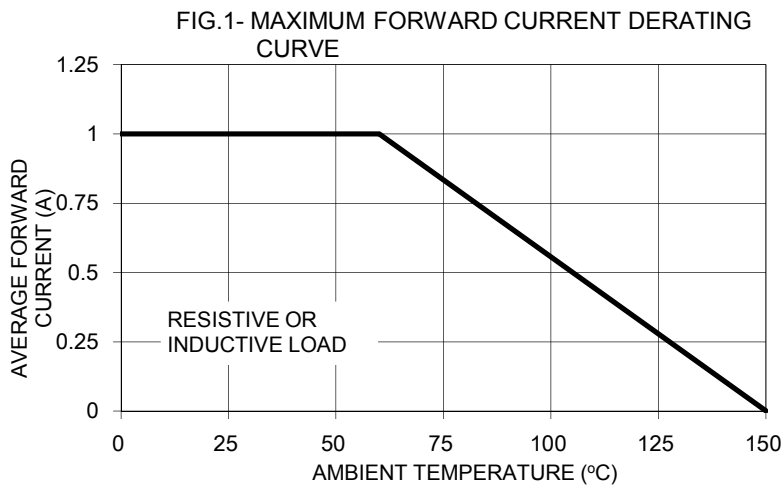

**FIG. 6- REVERSE RECOVERY TIME CHARACTERISTIC AND TEST CIRCUIT DIAGRAM**

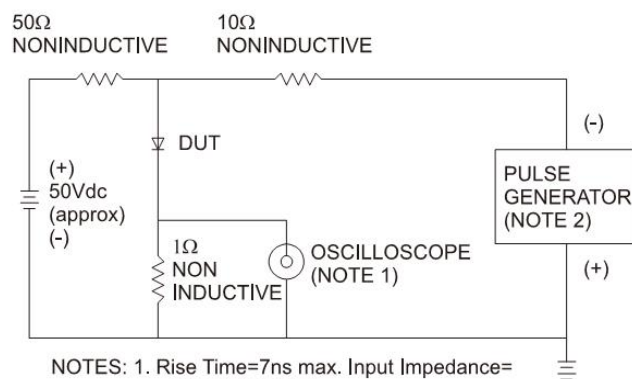

NOTES: 1. Rise Time=7ns max. Input Impedance=1 megohm 22pf  
2. Rise Time=10ns max. Source Impedance=50 ohms

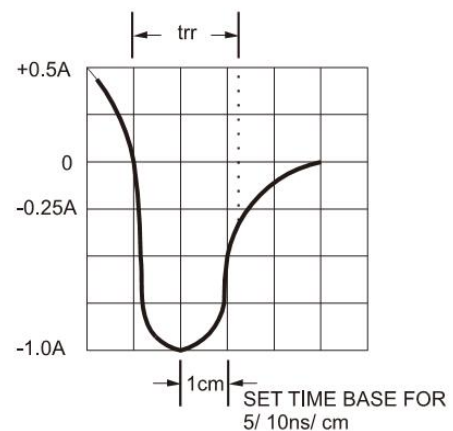

**Ordering information**

Part No.	Package	Packing	INNER TAPE	Packing code	Packing code (Green)
FR10x	DO-41	3K / AMMO box	52mm	A0	A0G
	DO-41	3K / AMMO box	26mm	A1	A1G
	DO-41	5K / 13" Reel	52mm	R0	R0G
	DO-41	5K / 13" Reel	52mm	R1	R1G
	DO-41	1K / Bulk packing		B0	B0G

Note: "x" is Device Code from "1" thru "7".

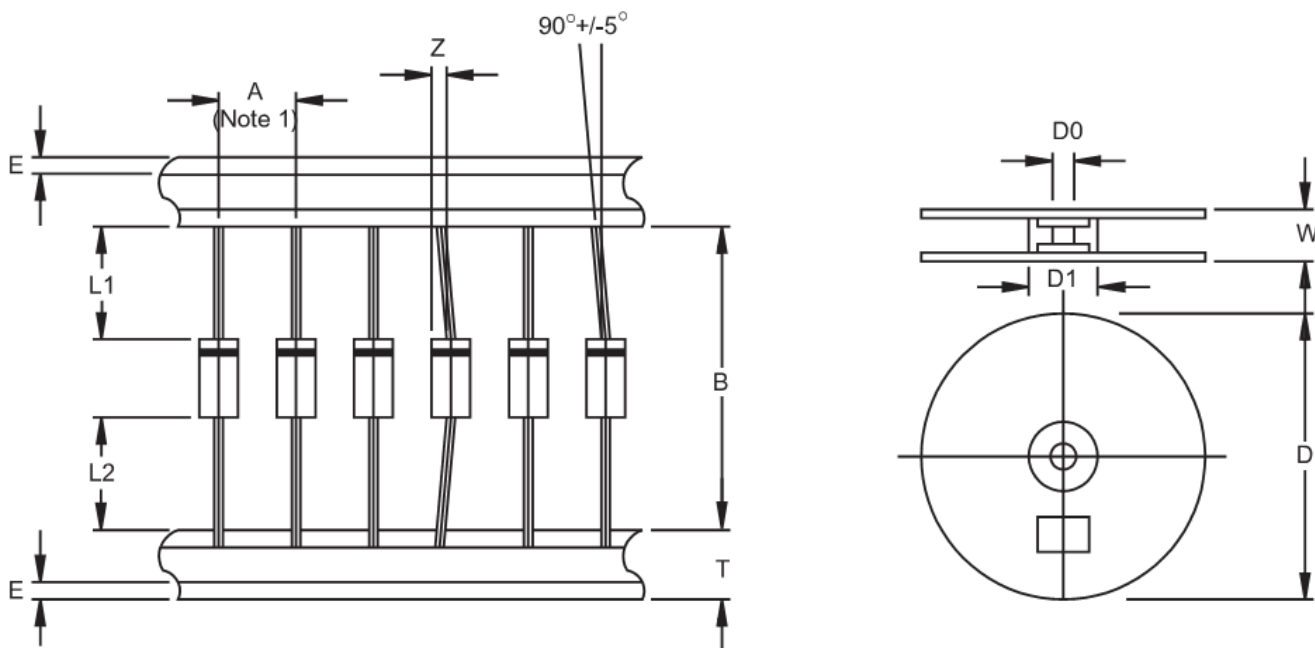
**AXIAL LEAD TAPING SPECIFICATIONS**

Outline	A	B	Z	T	E	L1-L2	D	D1	D0	W
	±0.5	±1.5	MAX	±0.4	MAX	MAX		±0.3	±0.4	±1.0
DO-41	5	26	1.2	6	0.8	1	330	85.7	16.6	76
DO-41	5	52.4	1.2	6	0.8	1	330	85.7	16.6	76

Unit (mm)

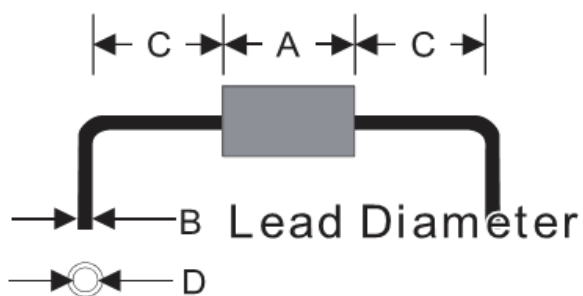
**Suggested Mounting Hole Rule**

Symbol	Unit(mm)
A	5.1
B	0.8
C	3.0
D	1.2

**Dimensions**

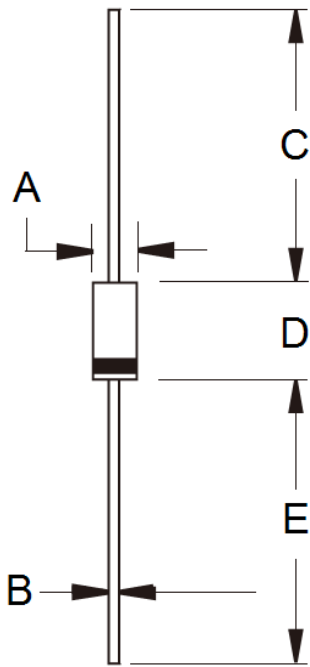

DIM.	Unit(mm)		Unit(inch)	
	Min	Max	Min	Max
A	2.00	2.70	0.079	0.106
B	0.71	0.86	0.028	0.034
C	25.40	-	1.000	-
D	4.20	5.20	0.165	0.205
E	25.40	-	1.000	-

**Marking Diagram**



- P/N = Specific Device Code
- G = Green Compound
- YWW = Date Code
- F = Factory Code