

ADSP-H1x1/H1x3

1.0" Single Digit PCB Based LED Display



Datasheet

Description

This is 1.0" height single digit display. It utilizes AllnGaP Red, Orange, Yellow, Green and Deep Red chips. This device is halogenated.

All devices are categorized for luminous intensity. The orange, yellow and green devices are categorized for color. Use of similar device categories will yield a uniform display.

Features

- High reliability
- Excellent characters appearance
- Available in CA and CC
- RoHS Compliant
- Gray top surface with white diffused segments.

Ordering Information

Red	Green	Yellow	Orange	Deep Red	Description
ADSP-H1E1	ADSP-H1G1	ADSP-H1Y1	ADSP-H1L1	ADSP-H1A1	Common Anode, Right Hand Decimal
ADSP-H1E3	ADSP-H1G3	ADSP-H1Y3	ADSP-H1L3	ADSP-H1A3	Common Cathode, Right Hand Decimal

Package Dimensions

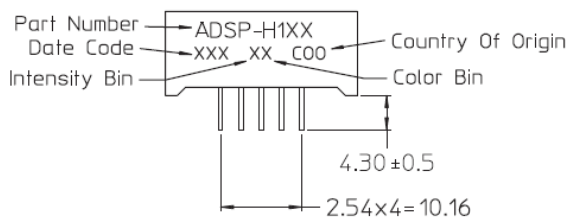
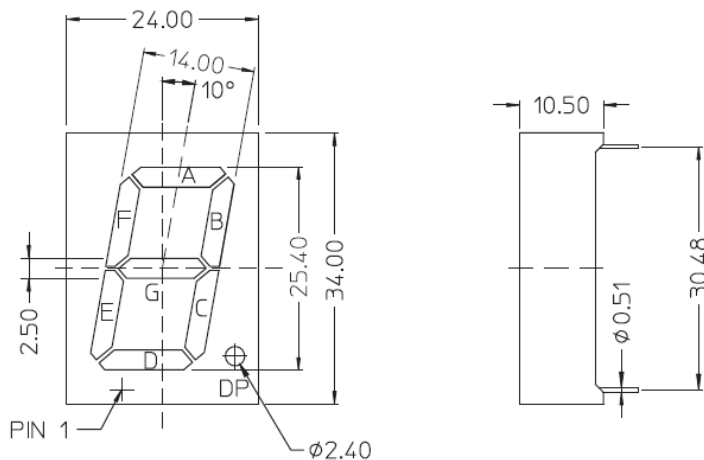

Notes:

1. All dimensions are in millimeter.
2. Unless otherwise stated, the tolerance is ± 0.25 mm.

For product information and a complete list of distributors, please go to our web site: www.avagotech.com

Avago, Avago Technologies, and the A logo are trademarks of Avago Technologies, Pte. in the United States and other countries. Data subject to change. Copyright © 2005 Avago Technologies Pte. All rights reserved. Obsoletes Pub No. Pub Number - Date (12/07/2012)



Circuit Diagram

Common Anode

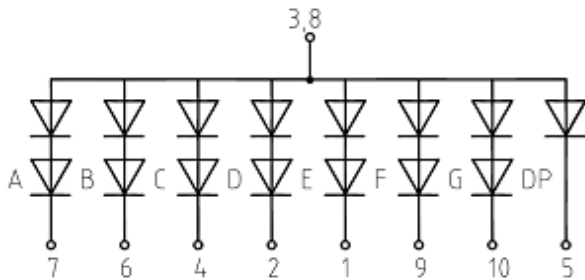

Common Cathode

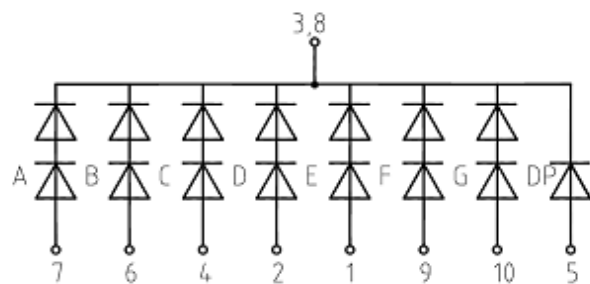

Absolute Maximum Ratings at $T_A = 25^\circ\text{C}$

Parameter	Symbol	Red/Yellow/ Orange/ Green/ Deep Red	Units
Power Dissipation per segment / Dot Point (DP)	P_D	104/52	mW
Continuous Forward Current per segment	I_F	20	mA
Peak Forward Current per segment (1/10 Duty Cycle, 0.1m sec pulse width)		100	mA
Derating Linearly from 25°C per segment		0.21	mA/ $^\circ\text{C}$
Reverse Voltage per segment / DP	V_R	10/5	V
Operating Temperature	T_O	-40 to 85	$^\circ\text{C}$
Storage Temperature	T_S	-40 to 85	$^\circ\text{C}$
Wave solder Condition 1.6mm below body		260 $^\circ\text{C}$ peak for 3 secs max	

For product information and a complete list of distributors, please go to our web site: www.avagotech.com

Avago, Avago Technologies, and the A logo are trademarks of Avago Technologies, Pte. in the United States and other countries. Data subject to change. Copyright © 2005 Avago Technologies Pte. All rights reserved. Obsoletes Pub No. Pub Number - Date (12/07/2012)

AVAGO
TECHNOLOGIES

Electrical / Optical Characteristic at $T_A = 25^\circ\text{C}$ **Red**

Parameter	Symbol	Min	Typ	Max	Units	Test Conditions
Average Luminous Intensity (Digit Average)	I_V	–	70	–	mcd	$I_F = 10\text{mA}$
Peak Wavelength	λ_P	–	634	–	nm	$I_F = 20\text{mA}$
Dominant Wavelength	λ_d	–	625	–	nm	$I_F = 20\text{mA}$
Forward Voltage per segment / DP	V_F	–	4.0/2.0	5.2/2.6	V	$I_F = 20\text{mA}$
Reverse Current per segment / DP	I_R	–	–	100	μA	$V_R = 10\text{V}/5\text{V}(\text{DP})$
Luminous Intensity Matching Ratio (Segment to Segment)	I_{V-M}		2:1			$I_F = 10\text{mA}$

Green

Parameter	Symbol	Min	Typ	Max	Units	Test Conditions
Average Luminous Intensity (Digit Average)	I_V	–	25	–	mcd	$I_F = 10\text{mA}$
Peak Wavelength	λ_P	–	570	–	nm	$I_F = 20\text{mA}$
Dominant Wavelength	λ_d	–	571	–	nm	$I_F = 20\text{mA}$
Forward Voltage per segment / DP	V_F	–	4.0/2.0	5.2/2.6	V	$I_F = 20\text{mA}$
Reverse Current per segment / DP	I_R	–	–	100	μA	$V_R = 10\text{V}/5\text{V}(\text{DP})$
Luminous Intensity Matching Ratio (Segment to Segment)	I_{V-M}		2:1			$I_F = 10\text{mA}$

Yellow

Parameter	Symbol	Min	Typ	Max	Units	Test Conditions
Average Luminous Intensity (Digit Average)	I_V	–	60	–	mcd	$I_F = 10\text{mA}$
Peak Wavelength	λ_P	–	592	–	nm	$I_F = 20\text{mA}$
Dominant Wavelength	λ_d	–	587	–	nm	$I_F = 20\text{mA}$
Forward Voltage per segment / DP	V_F	–	4.0/2.0	5.2/2.6	V	$I_F = 20\text{mA}$
Reverse Current per segment / DP	I_R	–	–	100	μA	$V_R = 10\text{V}/5\text{V}(\text{DP})$
Luminous Intensity Matching Ratio (Segment to Segment)	I_{V-M}		2:1			$I_F = 10\text{mA}$

For product information and a complete list of distributors, please go to our web site: www.avagotech.com

Avago, Avago Technologies, and the A logo are trademarks of Avago Technologies, Pte. in the United States and other countries. Data subject to change. Copyright © 2005 Avago Technologies Pte. All rights reserved. Obsoletes Pub No. Pub Number - Date (12/07/2012)



Orange

Parameter	Symbol	Min	Typ	Max	Units	Test Conditions
Average Luminous Intensity (Digit Average)	I_V	–	80	–	mcd	$I_F = 10\text{mA}$
Peak Wavelength	λ_P	–	610	–	nm	$I_F = 20\text{mA}$
Dominant Wavelength	λ_D	–	605	–	nm	$I_F = 20\text{mA}$
Forward Voltage per segment / DP	V_F	–	4.0/2.0	5.2/2.6	V	$I_F = 20\text{mA}$
Reverse Current per segment / DP	I_R	–	–	100	μA	$V_R = 10\text{V}/5\text{V}(\text{DP})$
Luminous Intensity Matching Ratio (Segment to Segment)	I_{V-M}		2:1			$I_F = 10\text{mA}$

Deep Red

Parameter	Symbol	Min	Typ	Max	Units	Test Conditions
Average Luminous Intensity (Digit Average)	I_V	–	70	–	mcd	$I_F = 10\text{mA}$
Peak Wavelength	λ_P	–	644	–	nm	$I_F = 20\text{mA}$
Dominant Wavelength	λ_D	–	635	–	nm	$I_F = 20\text{mA}$
Forward Voltage per segment / DP	V_F	–	4.0/2.0	5.2/2.6	V	$I_F = 20\text{mA}$
Reverse Current per segment / DP	I_R	–	–	100	μA	$V_R = 10\text{V}/5\text{V}(\text{DP})$
Luminous Intensity Matching Ratio (Segment to Segment)	I_{V-M}		2:1			$I_F = 10\text{mA}$

For product information and a complete list of distributors, please go to our web site: www.avagotech.com

Avago, Avago Technologies, and the A logo are trademarks of Avago Technologies, Pte. in the United States and other countries. Data subject to change. Copyright © 2005 Avago Technologies Pte. All rights reserved. Obsoletes Pub No. Pub Number - Date (12/07/2012)



Red

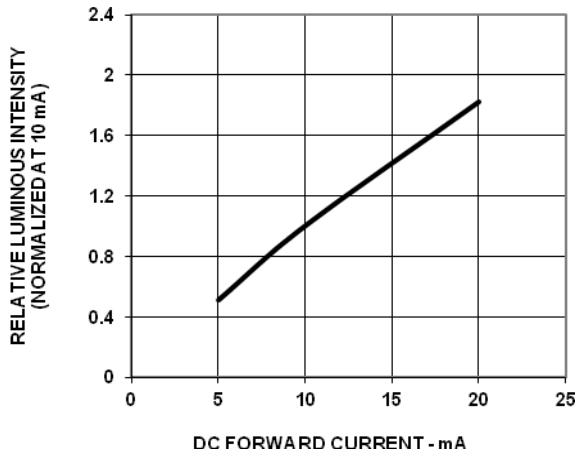

Fig 1: Relative Luminous Intensity Vs Forward Current

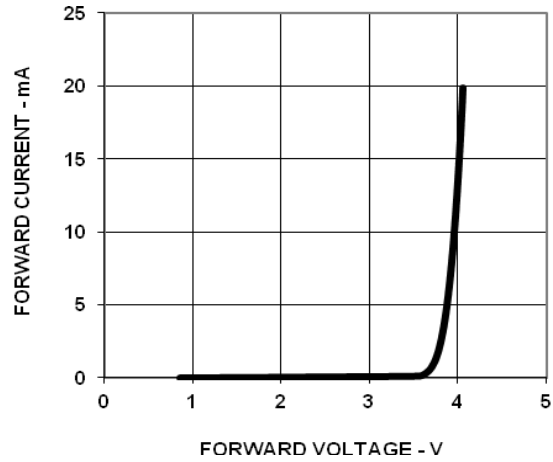

Fig 2: Forward Voltage Vs Current (Segment)

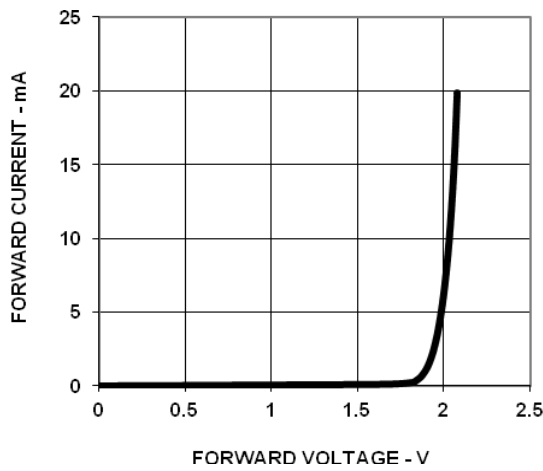

Fig 3: Forward Voltage Vs Current (DP)

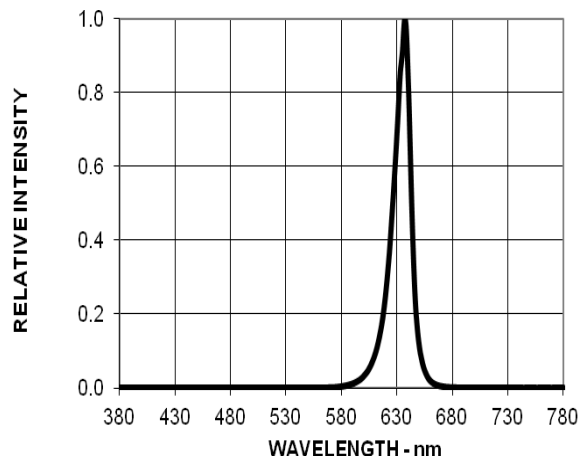

Fig 4: Relative Luminous Intensity Vs Wavelength

For product information and a complete list of distributors, please go to our web site: www.avagotech.com

Avago, Avago Technologies, and the A logo are trademarks of Avago Technologies, Pte. in the United States and other countries. Data subject to change. Copyright © 2005 Avago Technologies Pte. All rights reserved. Obsoletes Pub No. Pub Number - Date (12/07/2012)



Green

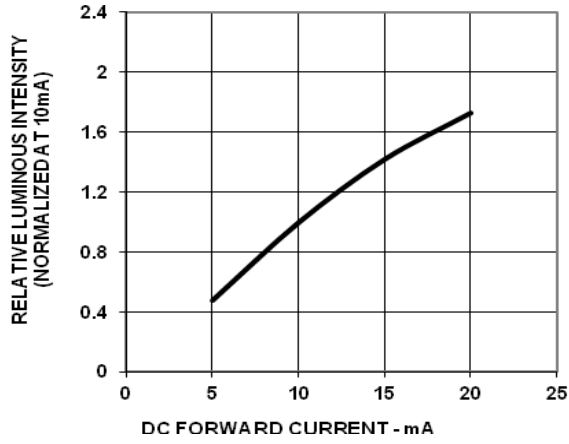

Fig 1: Relative Luminous Intensity Vs Forward Current

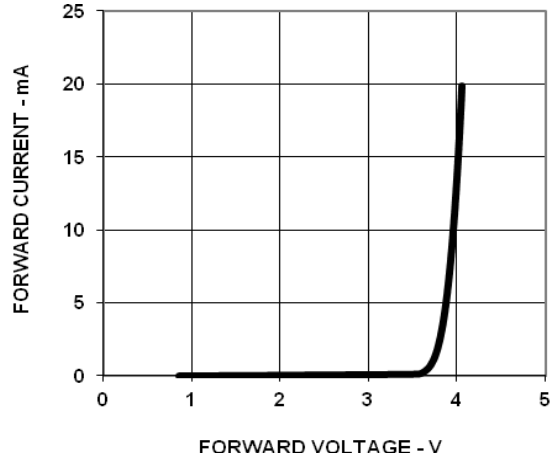

Fig 2: Forward Voltage Vs Current (Segment)

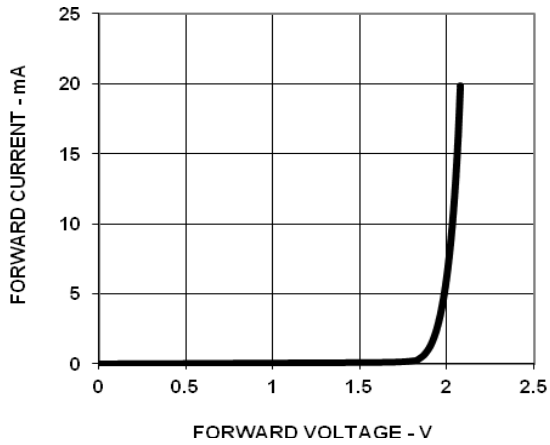

Fig 3: Forward Voltage Vs Current (DP)

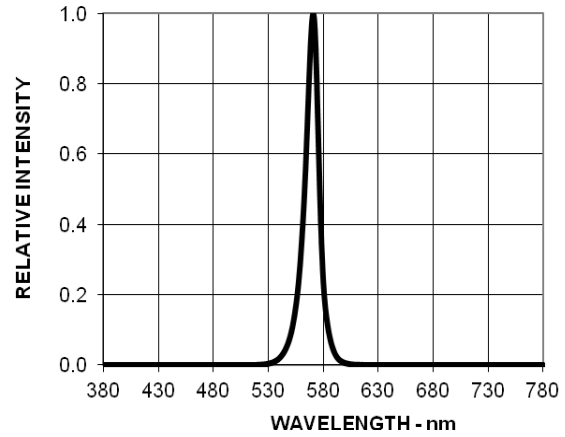

Fig 4: Relative Luminous Intensity Vs Wavelength

For product information and a complete list of distributors, please go to our web site: www.avagotech.com

Avago, Avago Technologies, and the A logo are trademarks of Avago Technologies, Pte. in the United States and other countries. Data subject to change. Copyright © 2005 Avago Technologies Pte. All rights reserved. Obsoletes Pub No. Pub Number - Date (12/07/2012)

AVAGO
TECHNOLOGIES

Yellow

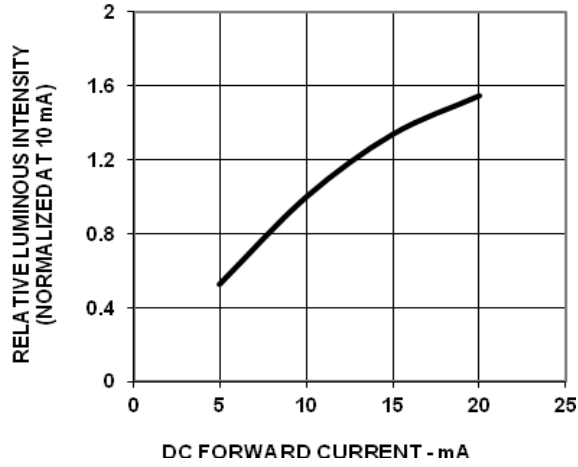

Fig 1: Relative Luminous Intensity Vs Forward Current

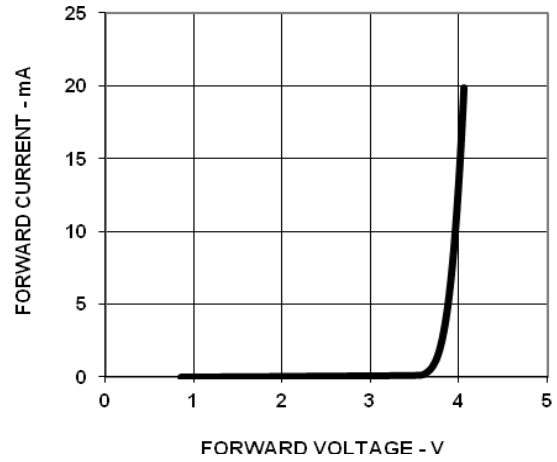

Fig 2: Forward Voltage Vs Current(Segment)

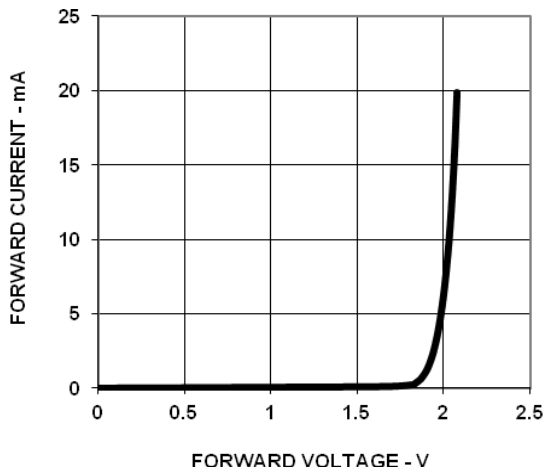

Fig 3: Forward Voltage Vs Current (DP)

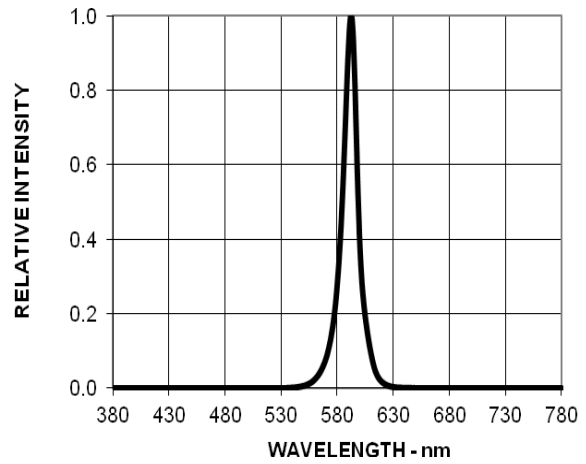

Fig 4: Relative Luminous Intensity Vs Wavelength

For product information and a complete list of distributors, please go to our web site: www.avagotech.com

Avago, Avago Technologies, and the A logo are trademarks of Avago Technologies, Pte. in the United States and other countries. Data subject to change. Copyright © 2005 Avago Technologies Pte. All rights reserved. Obsoletes Pub No. Pub Number - Date (12/07/2012)

AVAGO
TECHNOLOGIES

Orange

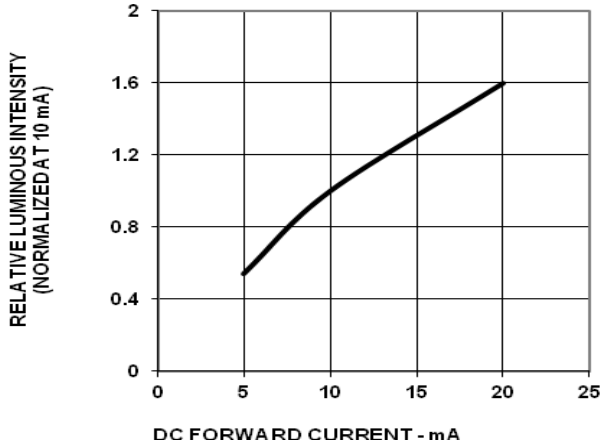

Fig 1: Relative Luminous Intensity Vs Forward Current

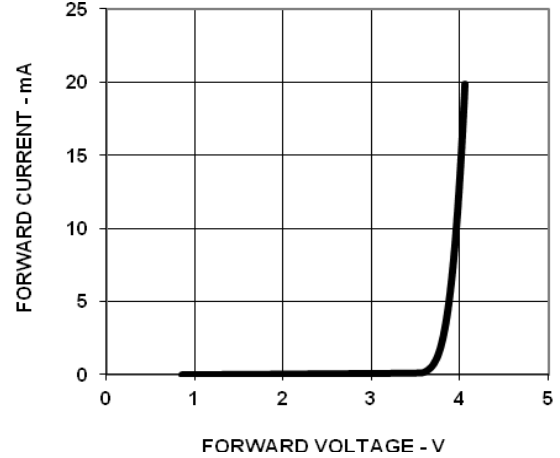

Fig 2: Forward Voltage Vs Current (Segment)

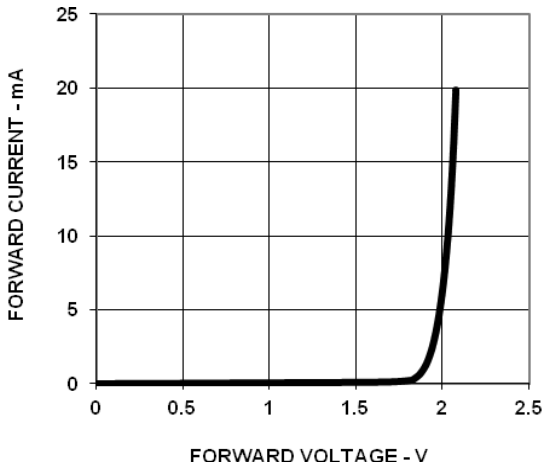

Fig 3: Forward Voltage Vs Current (DP)

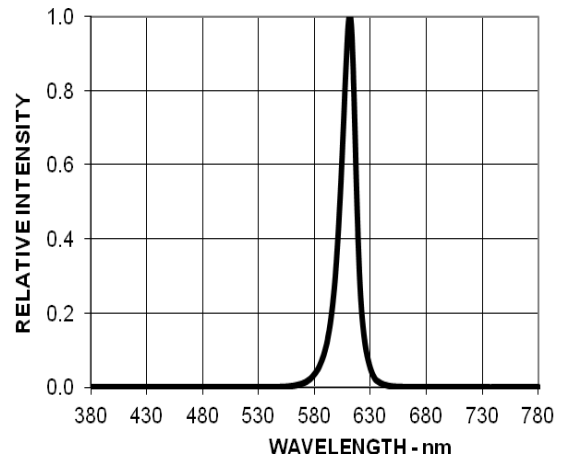

Fig 4: Relative Luminous Intensity Vs Wavelength

For product information and a complete list of distributors, please go to our web site: www.avagotech.com

Avago, Avago Technologies, and the A logo are trademarks of Avago Technologies, Pte. in the United States and other countries. Data subject to change. Copyright © 2005 Avago Technologies Pte. All rights reserved. Obsoletes Pub No. Pub Number - Date (12/07/2012)



Deep Red

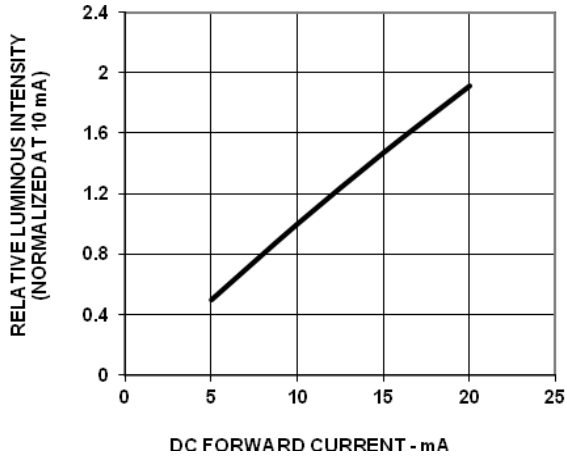

Fig 1: Relative Luminous Intensity Vs Forward Current

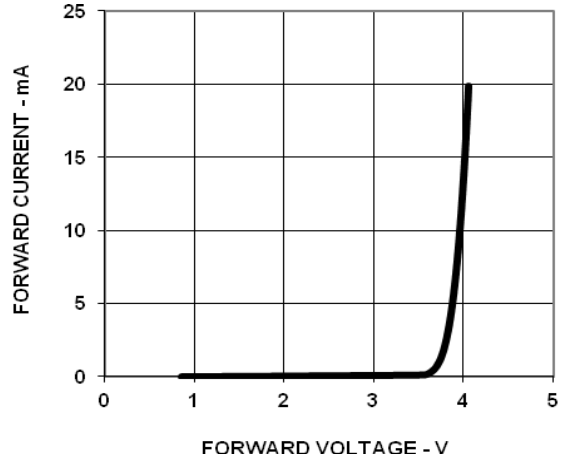

Fig 2: Forward Voltage Vs Current (Segment)

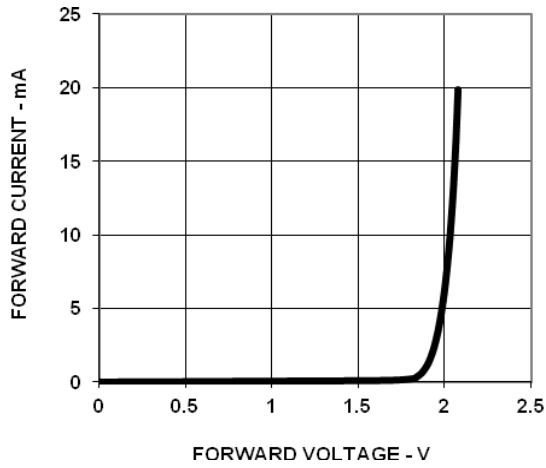

Fig 3: Forward Voltage Vs Current (DP)

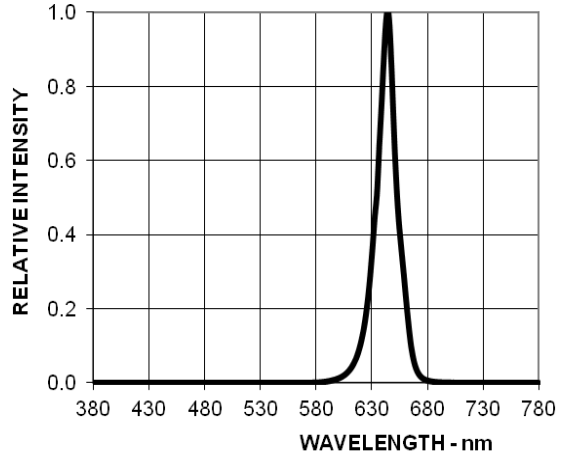

Fig 4: Relative Luminous Intensity Vs Wavelength

For product information and a complete list of distributors, please go to our web site: www.avagotech.com

Avago, Avago Technologies, and the A logo are trademarks of Avago Technologies, Pte. in the United States and other countries. Data subject to change. Copyright © 2005 Avago Technologies Pte. All rights reserved. Obsoletes Pub No. Pub Number - Date (12/07/2012)



Packing Tube Specifications:

20 PCS PRODUCTS PER IC TUBE

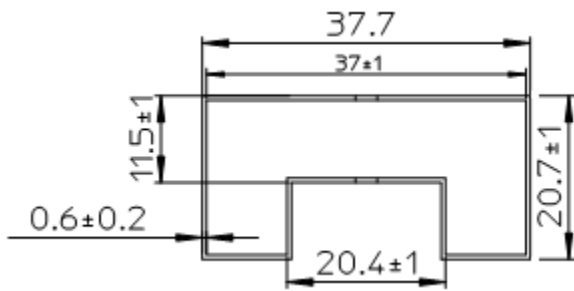
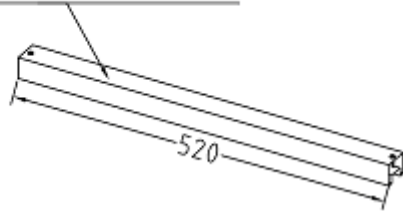

Tube Front View

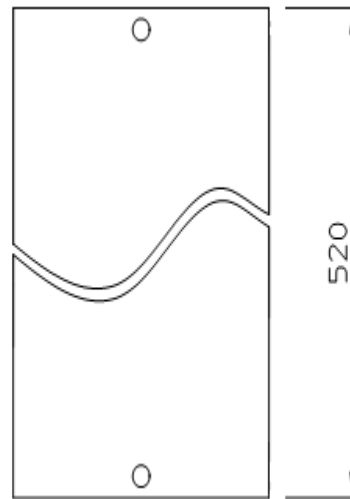

Tube Top View

Reference

For further information on soldering LEDs, please refer to Avago Technologies Application Note 1027.

For product information and a complete list of distributors, please go to our web site: www.avagotech.com

Avago, Avago Technologies, and the A logo are trademarks of Avago Technologies, Pte. in the United States and other countries. Data subject to change. Copyright © 2005 Avago Technologies Pte. All rights reserved. Obsoletes Pub No. Pub Number - Date (12/07/2012)

AVAGO
TECHNOLOGIES