

DISPLAYTRONIC

A DIVISION OF ZE XIAMEN CO., LTD.

SPECIFICATIONS FOR LIQUID CRYSTAL DISPLAY

PART NUMBER:

AGM 1232E SERIES

DATE:

FEBRUARY.10, 2001

1.0 MECHANICAL DIAGRAM

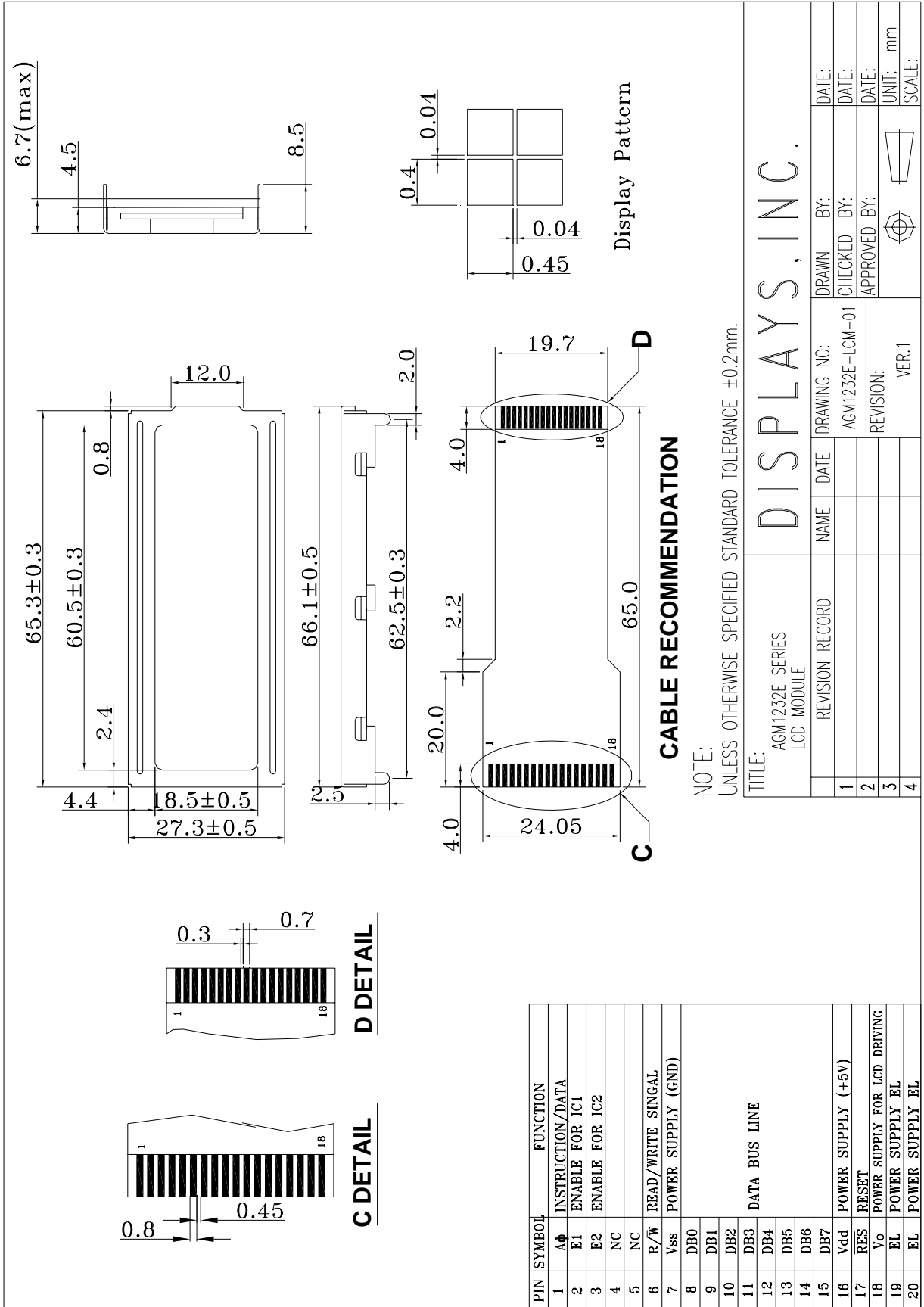

2.0 MECHANICAL SPECS

1. Item	Description
1. Overall Module Size	66.1mm(W) x 27.3mm(H) x max 8.4mm(D)
2. Dot Size	0.40mm(W) x 0.45mm(H)
3. Dot Pitch	0.44mm(W) x 0.49mm(H)
4. Duty	1/32
5. Controller IC	SED1520FOA/DOA
6. LC Fluid Options	STN, FSTN
7. Polarizer Options	Reflective, Transflective, Transmissive
8. Backlight Options	EL LED
9. Temperature Range Options	Standard (0°C ~ 50°C), Wide (-20°C ~ 70°C)

3.0 ABSOLUTE MAXIMUM RATINGS

Item	Symbol	Min	Typ	Max	Unit
Operating temperature (Standard)	Top	0	-	50	°C
Storage temperature (Standard)	Tst	-10	-	60	°C
Operating temperature (Wide temperature)	Top	-20	-	70	°C
Storage temperature (Wide temperature)	Tst	-30	-	80	°C
Input voltage	Vin	Vss		Vdd	V
Supply voltage for logic	Vdd- Vss	-0.3	-	7.0	V
Supply voltage for LCD drive	Vdd- Vo	3.5		9.5	V

4.0 ELECTRICAL CHARACTERISTICS

Item	Symbol	Condition	Min	Typ	Max	Unit
Input voltage (high)	Vih	H level	0.8Vdd	-	Vdd	V
Input voltage (low)	Vil	L level	0	-	0.2Vdd	V
Recommended LC Driving Voltage	Vdd -Vo	-20°C	-		9.5	V
		25°C		6.5	-	
		70°C	4.5		-	
Power Supply Current	Idd	Vdd=5.0V	-	-	13.0	mA
LED Power Supply Voltage	Vfled	R=6.8Ω	-	4.2		V
LED Power Supply Current	Ifled	R=6.8Ω	-		60	mA
EL	VEL			110		V

NOTE: Vfled = the voltage between LED 'A' and 'K'

5.0 OPTICAL CHARACTERISTICS

Item Mode		Cr (Contrast Ratio)		θ (Viewing Angle)		ϕ (Viewing Angle)	
		25°C		25°C		25°C	
		MIN.	TYP.	MIN	TYP.	MIN	TYP.
R	A	2.8	3.05	80°	85°	-	35°
	B	7.10	7.70	80°	85°	-	35°
	C	-	-	-	-	-	-
S	A	2.49	2.99	80°	85°	-	35°
	B	7.05	7.55	80°	85°	-	35°
	C	-	-	-	-	-	-

Note:

- R: Reflective
- S: Transflective
- A: STN Gray
- B: STN Yellow
- C: FSTN

At: $\phi = 0^\circ, \theta = 0^\circ$

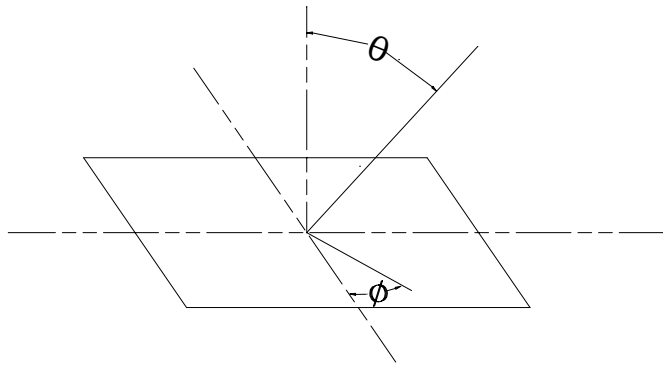

Item	Symbol	Condition	Min	Typ	Max	Unit
Response time (rise)	Tr	25 °C	-	80	160	ms
Response time (fall)	Tf	25°C	-	50	100	ns

6.0 BLOCK DIAGRAM

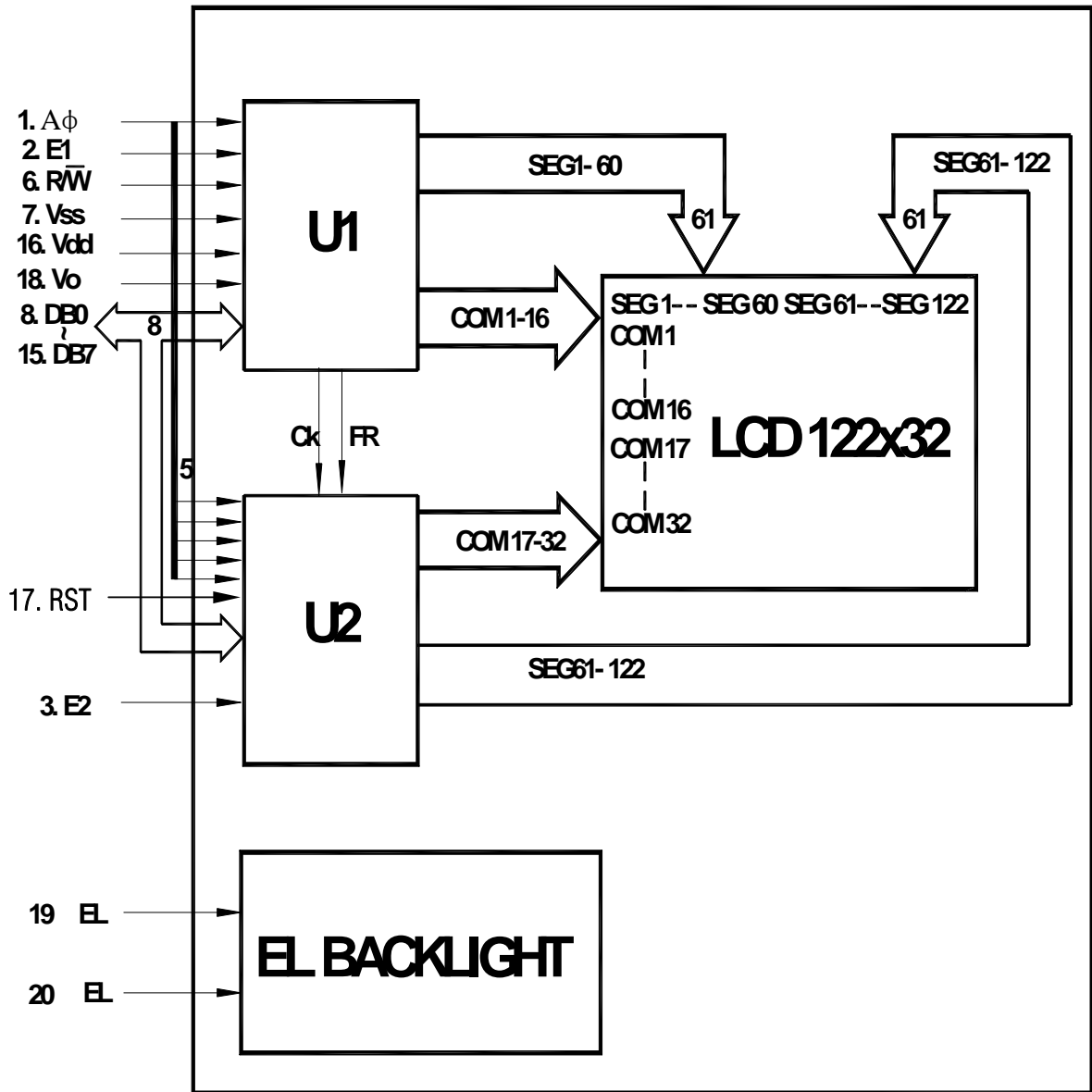

7.0 PIN ASSIGNMENT

Pin No.	Symbol	Function	Level
1	A0	Instruction/Data	H/L
2	E1	Enable for IC1	H/L
3	E2	Enable for IC2	H/L
4	NC		
5	NC		
6	R/W	H: Data read L: Data write	H/L
7	Vss	Ground	-
8	DB0	Data bit 0	H/L
9	DB1	Data bit 1	H/L
10	DB2	Data bit 2	H/L
11	DB3	Data bit 3	H/L
12	DB4	Data bit 4	H/L
13	DB5	Data bit 5	H/L
14	DB6	Data bit 6	H/L
15	DB7	Data bit 7	H/L
16	Vdd	Power Supply For Logic Circuit	
17	RST	Reset	
18	Vo	Power Supply For LCD Driving	
19	EL	Power Supply for EL	-
20	EL	Power Supply for EL	-

8.0 POWER SUPPLY

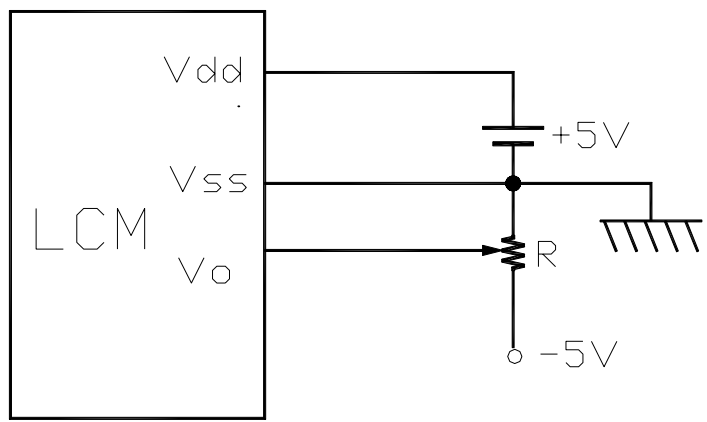

9.0 TIMING CHARACTERISTICS

Item	Symbol	Test Condition	Min.	Tvp.	Max.	Unit
System cycle time	t_{CYC6}	Fig. a, Fig. b	1000	-	-	ns
Address setup time	t_{AW6}	Fig. a, Fig. b	20	-	-	ns
Address hold time	t_{AH6}	Fig. a, Fig. b	10	-	-	ns
Data hold time	t_{DH6}	Fig. a	10	-	-	ns
Data setup time	t_{DS6}	Fig. a	80	-	-	ns
Output disable time	t_{OH6}	CL=100 pF	10	-	60	ns
Access time	t_{ACC6}		-	-	90	
Enable pulsewidth	Read	T_{EW}	100			
	Write		80			
Rise and fall time	T_r, T_f	Fig. a, Fig. b	-	-	15	ns

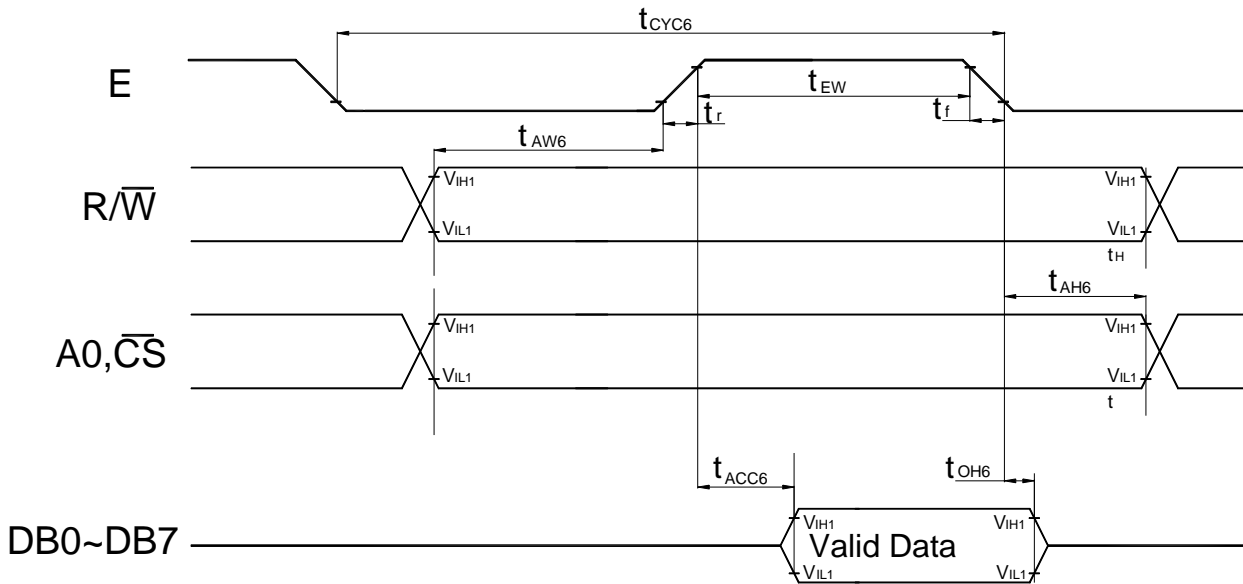

Fig. a Interface timing (data Read)

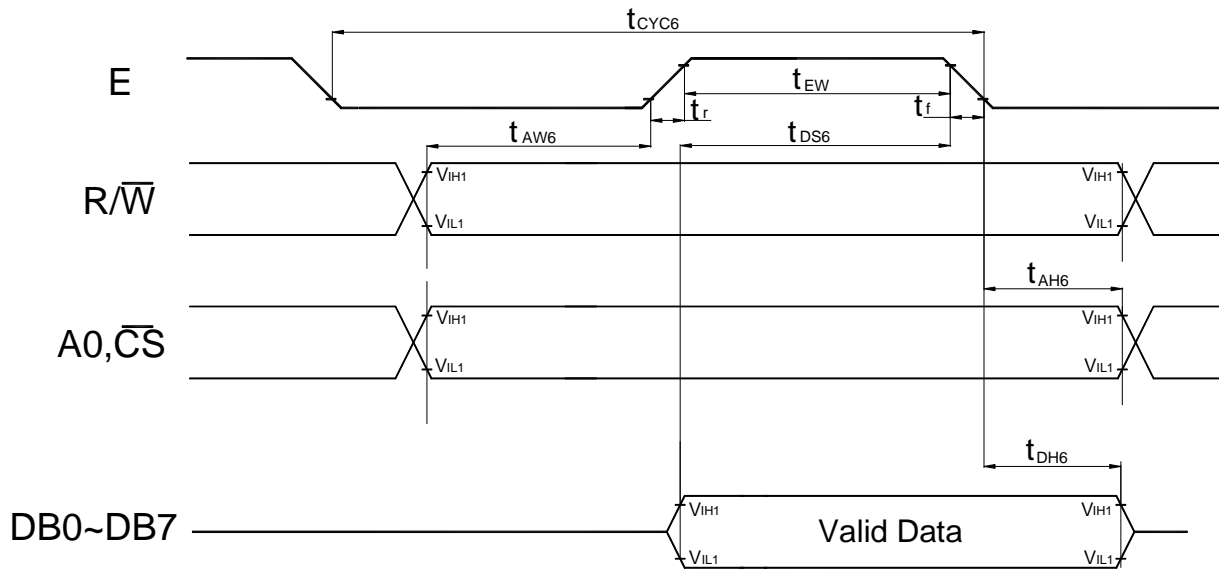

Fig. b Interface timing (data Write)

10.0 RELIABILITY TEST

Storage Condition	Content	Evaluations and Assessment*			
		Current Consumption	Oozing	Contrast	Other Appearances
Operation at high temperature and humidity	40°C, 90% RH, 240hrs	Twice initial value or less	none	More than 80% of initial value	No abnormality
High temperature storage	60°C, 240hrs	Twice initial value or less	none	More than 80% of initial value	No abnormality
Low temperature storage	-20°C, 240hrs	Twice initial value or less		More than 80% of initial value	No abnormality

*Evaluations and assessment to be made two hours after returning to room temperature (25°C±5°C).

*The LCDs subjected to the test must not have dew condensation.

11.0 RELATION BETWEEN DISPLAY PATTERN AND DRIVERS

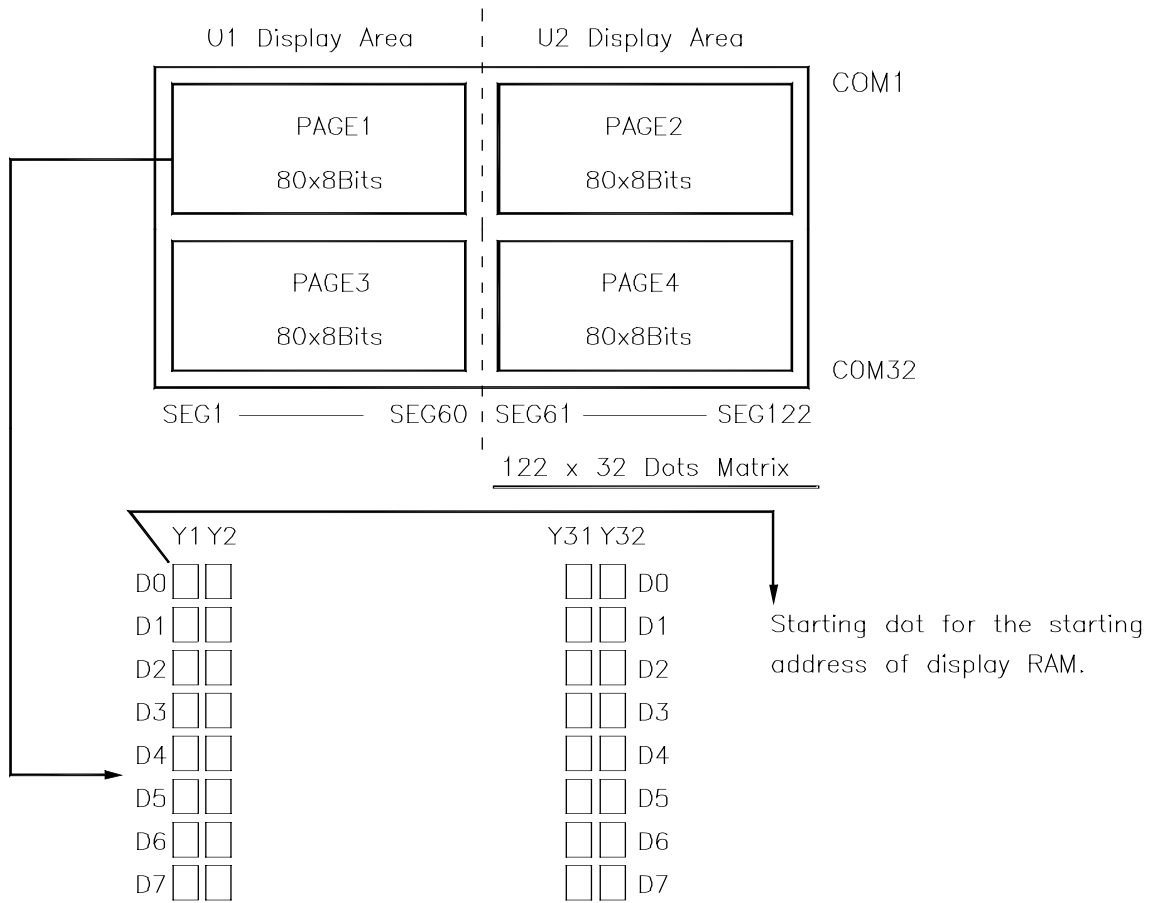

Each segment driver has 4 pages RAM, and each page has 80x8 bits RAM. D0~D7 are 8 bits transmitted data, where D0 is LSB and D7 is MSB.

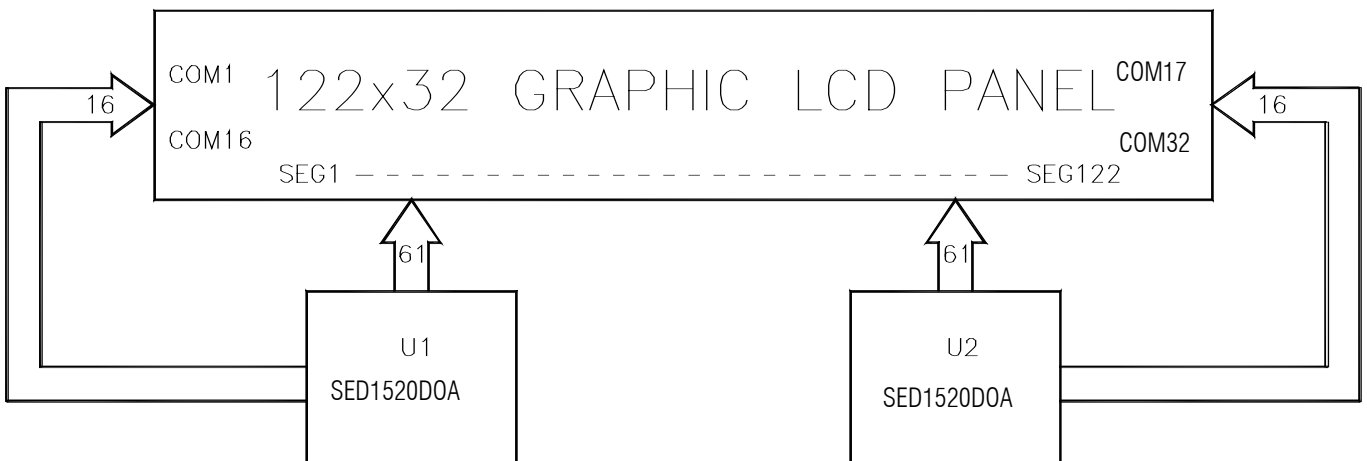

12.0 DISPLAY CONTROL INSTRUCTION

The display control instructions control the internal state of the SED1520DOA/FOA. Instructions are received from MPU to SED1520DOA/FOA for the display control.

INSTRUCTION	A0	RD	R/W	DB7	DB6	DB5	DB4	DB3	DB2	DB1	DB0	DESCRIPTION
Display ON/OFF	0	1	0	1	0	1	0	1	1	1	1/0	Turns display on or off. 0: OFF. 1:ON
Set Page Address	0	1	0	1	0	1	1	1	0	Page (0~3)		Sets display RAM Page in Page address register
Set Column (Segment address)	0	1	0	0	Column address (0~79)						Sets display RAM column address in column address register	
Display Start Line	0	1	0	1	1	0	Display start line (0~31)					Indicates the display data RAM displayed at the top of the screen.
Status Read	0	0	1	BUSY	ADC	ON/OFF	RESET	0	0	0	0	Reads the following status: BUSY 0: Ready 1: Busy ADC 1: CW output 0: CCW output ON/OFF 0: Display on 1: Display off RESET 0: Normal 1: Being Reset
Write Display Data	1	1	0	Write Data								Writes data DB0~DB7 from bus into display data RAM.
Read Display Data	1	0	1	Read Data								Reads data DB0~DB7 from display data RAM onto the data bus.
Select ADC	0	1	0	1	0	1	0	0	0	0	0/1	0: CW output, 1: CCW output
Static drive ON/OFF	0	1	0	1	0	1	0	0	1	0	0/1	1: Static drive, 0: Normal driving
Select duty	0	1	0	1	0	1	0	1	0	0	0/1	Select LCD duty cycle 1:1/32, 0: 1/16
Read-Modify-Wreti	0	1	0	1	1	1	0	0	0	0	0	Read-Modify-write ON
END	0	1	0	1	1	1	0	1	1	1	0	Read-Modify-write OFF
Reset	0	1	0	1	1	1	0	0	0	1	0	Software reset