

Design Guide

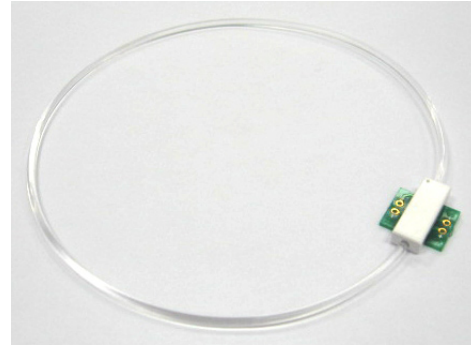

Introduction

The design guide describes the reference design hardware and firmware implementation, thus this documentation is useful to streamline the design process and to ensure they design a product into their system/product correctly.

The flexible light strip module is a high performance light tube, integrating LED solutions with excellent thermoplastic polyurethane. This light strip is an environmentally friendly "green material" which can be applied for a variety of consumer and industrial applications. The light strip makes it convenient for the designer to integrate the light strip into their devices with minimum consideration for optical and mechanical optimization. Flexible light strips have multi-functionality which is ideal for electronic product designers to add as decorative trim around computer mice, decorative lighting or even portable hand-held devices such as cellular phones, MP3 players and games.

Any artwork supplied can be animated to light per specifications. This module solution can be customized to illuminate in any length, shape, color or sequence. The potential of this product is unlimited across a wide range of applications.

Configurations & Features

- Outstanding abrasion resistance
- Excellent mechanical properties
- Excellent chemical resistance
- Excellent light transitivity
- High shaping flexibility
- Available length 100 to 500mm at interval of 1mm
- Available voltage source : 5V, 9V and 12V
- Available color : Blue, Green, Red and White
- Available in various flexible shapes

Components

- FR4 laminated PCB
- JLED
- Resistor 68 Ω /47 Ω /470 Ω (check symbols here)
- Light strip elastomer
- Mold housing
- Glue

Design Recommendations

- The flexible light strip module can be connected using the hook method to the customer's motherboard. It is simple to use, helps to lower customer costs and eliminates concerns over optical and mechanical coupling as shown in Figure 1 below.

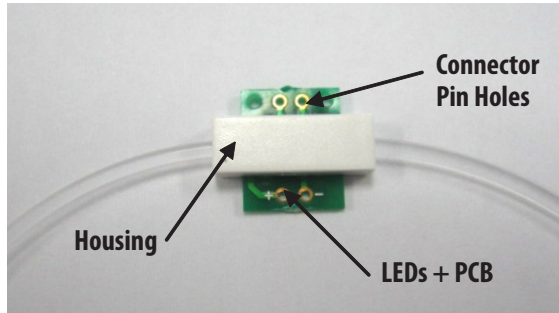

Figure 1.

- The special designed housing helps to concentrate the light for maximum efficiency.
- The special designed PCB provides plug & play type of solution for assembly.
- The flexible light strip module can be directly connected to the customer's PCB board provided that the PCB board still has some space for extra circuitry implementation, this can help lower overall costs.
- Some handling precautions, shown below, are needed in order to prevent any damage detection or light transmission error on the flexible light strip.
 - Rubber gloves should be worn in order to avoid dirt from hands on the flexible light strip.



- Reduce static electricity for easy handling.



- The flexible light strip is not to be stretched, fastened, wrenched and bent. No heavy load to be set on it or dropped on it.

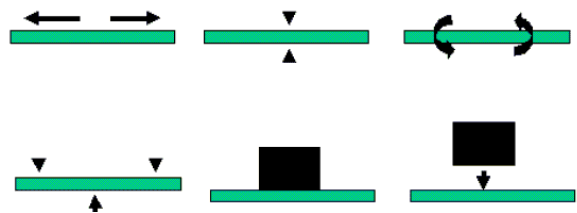

- During installation, avoid any sharp edges so as not to damage the flexible light strip surface.

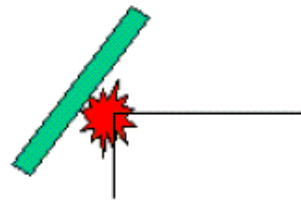

- Use Ethanol or IPA with a soft cloth or paper to clean the flexible light strip. Avoid rough surface material such as sand paper, in cleaning this product.

Environmental Requirements

Operating temperature range	-30°C to 60°C
Storage temperature range	-30°C to 60°C
Recommended LED driving voltage	5V, 9V or 12V
Current	Typ : 20mA, Max : 30mA
Manual soldering temperature	350°C for 3 second max

Simple PCB Circuitry Schematic of Flexible Light Strip Module

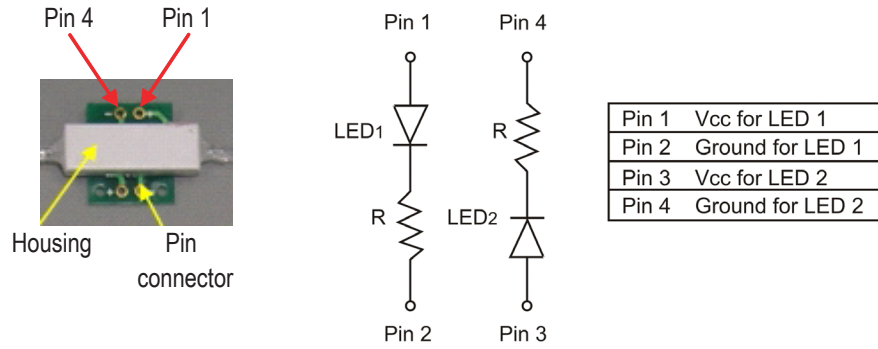

Listing and Use of Peripherals

- A connector is recommended to plug and play the flexible light strip module as shown in the figure below.

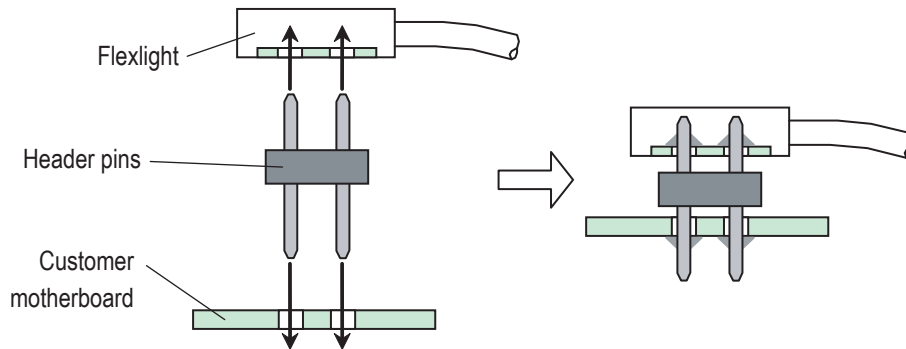

Fault Management & Corrective Actions

- The minimum bending radius of the flexible light strip should always be 10 times larger than its diameter, to avoid any impact to its appearance and performance.

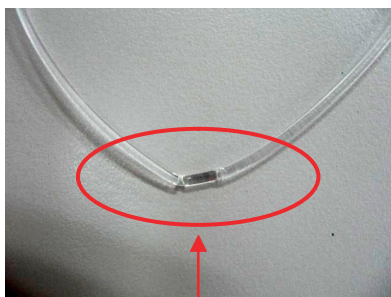

Broken area of strip if the bending radius is too small

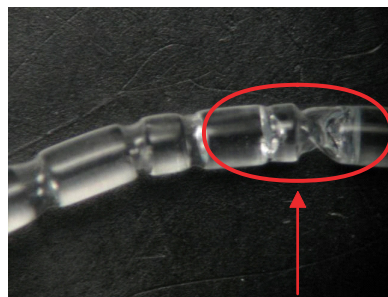

Dented or damaged portion

Do not use excessive force or load on the light strip. It will dent or damage it as shown in the image below.

The units are arranged in sequence as shown in Table 1.

Table 1.

a) From J to F of Row 4	e) From J to F of Row 2
b) From E to A of Row 4	f) From E to A of Row 2
c) From J to F of Row 3	g) From J to F of Row 1
d) From E to A of Row 3	h) From E to A of Row 1

Remove the units in that same sequence to avoid the stress and peeling from the light pipe housing.

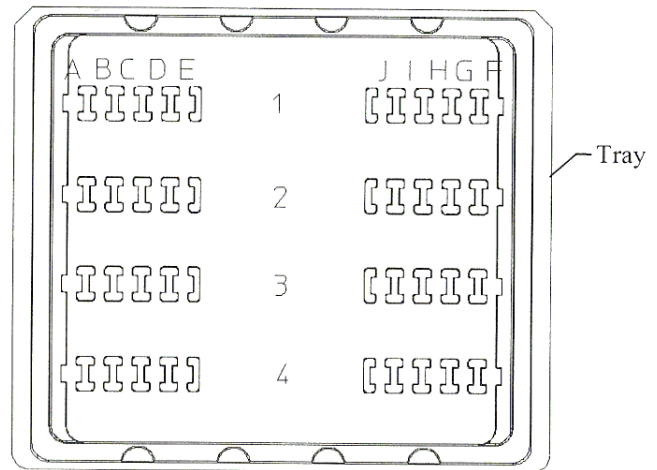

Functionality & Advantages

- DC driven with low voltage operation
- Hazard free
- No EM noise generation
- Low power consumption
- Multiple colors in a single tube (with multiple color LED light source)
- LEDs have longer life and less maintenance
- No heat generated in the light tube
- Safe if accidentally touched during operation
- Robust construction. No breakable parts

Required Certification Standards

- UL 94-V and UL94HB flammability rating
- UV tested to 400hrs using UV carbon arc fadometer at 63°C

Applications

- Handheld devices
- Cellular phones
- Decorative lighting
- Electronic and electrical appliances



Flexible Light Strip Module Implementation

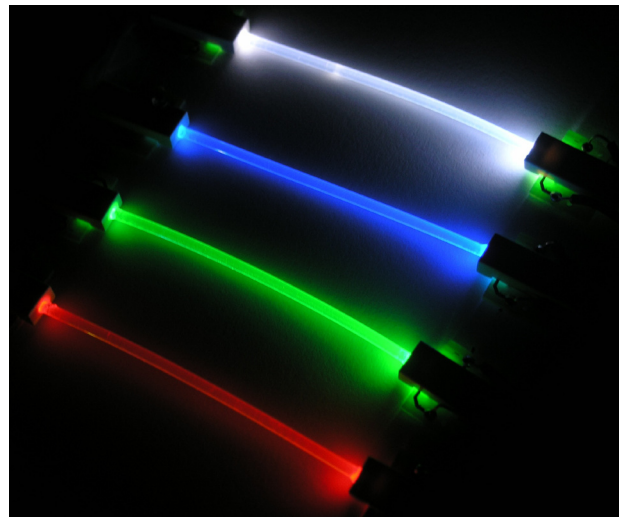
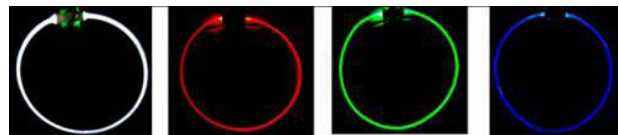

DISCLAIMER: All materials contained in this Design Guide are protected by copyright laws, and may not be reproduced, republished, distributed, transmitted, displayed, broadcast or otherwise exploited in any manner without the express prior written permission of Avago Technologies or the author(s). Content may be changed without notice.

For product information and a complete list of distributors, please go to our web site: www.avagotech.com

Avago, Avago Technologies, and the A logo are trademarks of Avago Technologies, Limited in the United States and other countries. Data subject to change. Copyright © 2007 Avago Technologies Limited. All rights reserved. AV02-0374EN - July 2, 2007