

COB

6.4W Series

PRELIMINARY

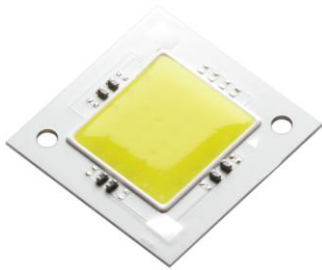

Introduction

Everlight's COB Series is an MCPCB substrate based LED achieving high efficiency while maintaining high CRI at Energy Star / ANSI color temperature ranges. In addition, Everlight's unique design intelligence allows the COB to maintain a small CCT shift over low to high operating conditions.

Features

- ◆ High Power COB & High CRI LED
- ◆ Multi-Chip Solution
- ◆ Dimension: 30 mm x 30mm x 1.65mm
- ◆ Main Parameters: Luminous Flux, Forward Voltage, Chromaticity and Color Rendering Index
- ◆ ESD Protection
- ◆ RoHS compliant
- ◆ Energy Star / ANSI Compliant Binning Structure
- ◆ Typical Viewing Angle: 120°

Applications

- ◆ Replacement Bulb
- ◆ Indoor General Lighting
- ◆ Recessed Can

Table of Contents

Table of Contents	2
Product Nomenclature	3
Absolute Maximum Ratings.....	4
Luminous Flux Characteristics for the COB series	4
PN of the COB 6.4W Series: White LEDs.....	5
Product Binning:Luminous Flux Bins.....	6
Product Binning:Warm White Bin Structure	7
Product Binning:Warm White Bin Coordinates.....	7
Product Binning: Forward Voltage Bins	8
Mechanical Dimension.....	9
Pad Configuration	10
6.4W COB Typical Electro-Optical Characteristic Curve	11
Product Labeling	16
Carrier Tray Specification	16
Recommended Installation Screw Pitch	17
Precautions of Use	18
Revision History	20

Product Nomenclature

The product name is designated as below:

ELCOB – ABCDE – FGHIJ – V1234

Designation:

AB = minimum luminous flux (lm) or radiation power (mW) performance

C = radiation pattern / lens type^[1]

D = color^[2]

E = power consumption^[3]

F = reserved for future product offerings

G = internal coding

H = packaging type^[4]

IJ = internal coding

V = forward voltage bin

1234 = color bin or CCT bin

Notes

1. Table of radiation patterns / lens type

Symbol	Description
0	No Lens

2. Table of color offerings:

Symbol	Color	Dominant wavelength range/Peak wavelength/CCT
C	Cool-White	4745~7050K
N	Neutral-White	3710~4745K
M	Warm-White	2580~3710K

3. Table of power consumptions:

Symbol	Description
6	6~6.9W

4. Table of packaging types:

Symbol	Description
T	Tray

Absolute Maximum Ratings

Parameter	Symbol	Ratings	Unit
		5W _[1] / 6.4W	
Max. DC Forward Current (mA)	I _F	230 / 300	mA
Max. Peak Pulse Current (mA)	I _{Pulse}	450 _[2]	mA
Thermal Resistance	R _{th}	1~2	°C/W
Max. Junction Temperature	T _J	115	°C
Operating Temperature	T _{Opr}	-40 ~ +85	°C
Storage Temperature	T _{Stg}	-40 ~ +100	°C
Max. Soldering Temperature	T _{Sol}	260	°C

Notes:

1. If the 5W operation is required, it is suggested to lower the driving current of 6.4W product down to 230mA
2. $t_p \leq 100ms$, Duty cycle = 25%

Luminous Flux Characteristics for the COB series

Color	Part Number	6.4W		
		Minimum Luminous Flux (lm)	Typical Luminous Flux (lm)	Drive Current (mA)
Warm White	ELCOB- N50M6	600	625	300
Cold White	ELCOB- N40C6	550	610	300

Note:

1. Luminous flux measurement tolerance: $\pm 10\%$.
2. The data of luminous flux measured at thermal pad=25°C
3. Typical luminous flux or light output performance is operated within the condition guided by this datasheet.

PN of the COB 6.4W Series: Warm white LEDs

The table below is a list of part numbers for the Everlight COB 6.4W Series White LED. All parts listed match ANSI binning standards. Bin offerings of 2700K are listed and currently available. CRI is also listed with min 80. Typical viewing angle is 120°. These clearly listed binning options allow for proper design and implementation into lighting applications. The Order Codes below are currently available White COB LEDs. For example: If you order product using P/N **ELCOB-N50M6-0LTJE-C2700**, you will get Warm White, COB series LEDs at 300mA are listed below.

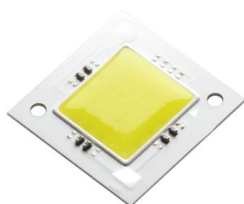

Color	CRI	CCT	Forward Voltage (V)	Minimum Luminous Flux (lm)
Warm White	80	27K-1 ~ 27K-2 ~ 27K-3 ~ 27K-4	19.5~21.0(T4) 21.0~22.5(T5) 22.5~24(T6)	600

COB 6.4W series LEDs at 300mA are listed below

Color	Order Code of ELCOB	Minimum Luminous Flux (lm)	Typical Luminous Flu (lm)	CCT (K)	Forward Voltage (V)	CRI (min)[1]	Typical Viewing Angle (degrees) 2θ _{1/2} [3]
Warm White 2700	ELCOB-N50M6-0LTJE-C2700	600	625	2700-1~2700-4	19.5~24.0	80[2]	120
Cold White 5000	ELCOB-N40C6-0LTGE-C5000	550	610	5000-1~5000-4	19.5~24.0	70[2]	120

Note:

1. The CRI value is based on the Everlight testing instrument.
2. CRI measurement tolerance: ±2.
3. Viewing angle is the width of half the light output intensity in all directions of 180°.

Product Binning

Luminous Flux Bins

Group	Bin	Minimum Photometric Flux (lm)	Maximum Photometric Flux (lm)
E	1	4	5
	2	5	6
	3	6	8
	4	8	10
	5	10	13
	6	13	17
	7	17	20
	8	20	23
	9	23	27
F	1	27	33
	2	33	39
	3	39	45
	4	45	52
	5	52	60
	6	60	70
	7	70	80
	8	80	90
	9	90	100
J	1	100	110
	2	110	120
	3	120	130
	4	130	140
	5	140	150
	6	150	160
	7	160	180
	8	180	200
	9	200	225

Group	Bin	Minimum Photometric Flux (lm)	Maximum Photometric Flux (lm)
K	1	225	250
	2	250	275
	3	275	300
	4	300	325
	5	325	350
	6	350	375
	7	375	400
	8	400	425
	9	425	450
N	1	450	475
	2	475	500
	3	500	550
	4	550	600
	5	600	650
	6	650	700
	7	700	750
	8	750	800

Warm White Bin Structure

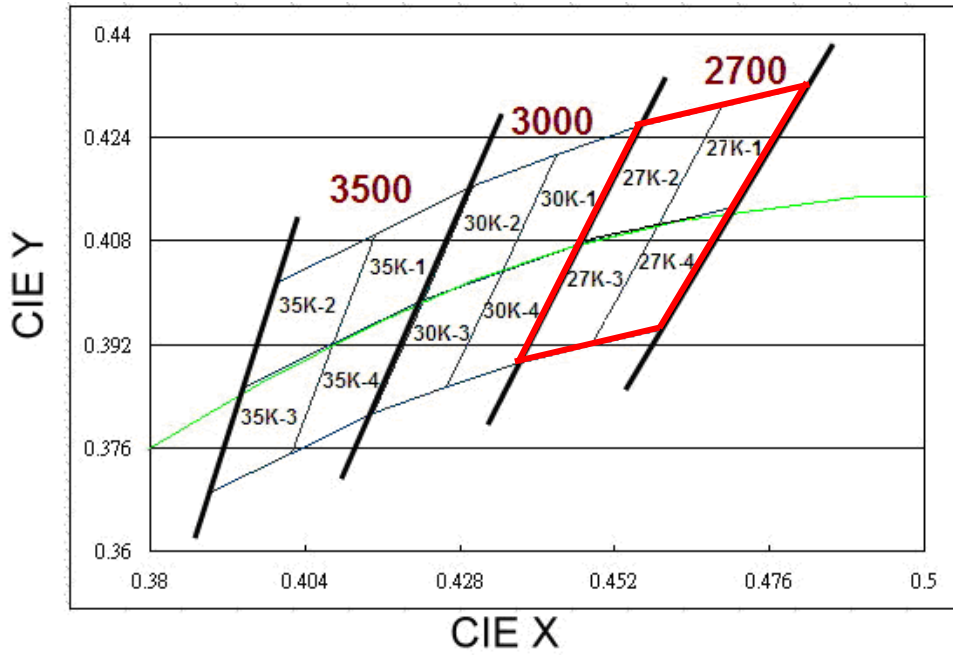

Warm White Bin Coordinates

2700K

Bin	CIE X	CIE Y
27K-1	0.469	0.429
	0.459	0.410
	0.470	0.413
	0.481	0.432
Reference Range: 2580~2700K		

Bin	CIE X	CIE Y
27K-2	0.456	0.426
	0.447	0.408
	0.459	0.410
	0.469	0.429
Reference Range: 2700~2870K		

Bin	CIE X	CIE Y
27K-4	0.459	0.410
	0.448	0.392
	0.459	0.394
	0.470	0.413
Reference Range: 2580~2700K		

Bin	CIE X	CIE Y
27K-3	0.447	0.408
	0.437	0.389
	0.448	0.392
	0.459	0.410
Reference Range: 2700~2870K		

Notes:

1. Color coordinates measurement allowance : ± 0.01

Cold White Bin Structure

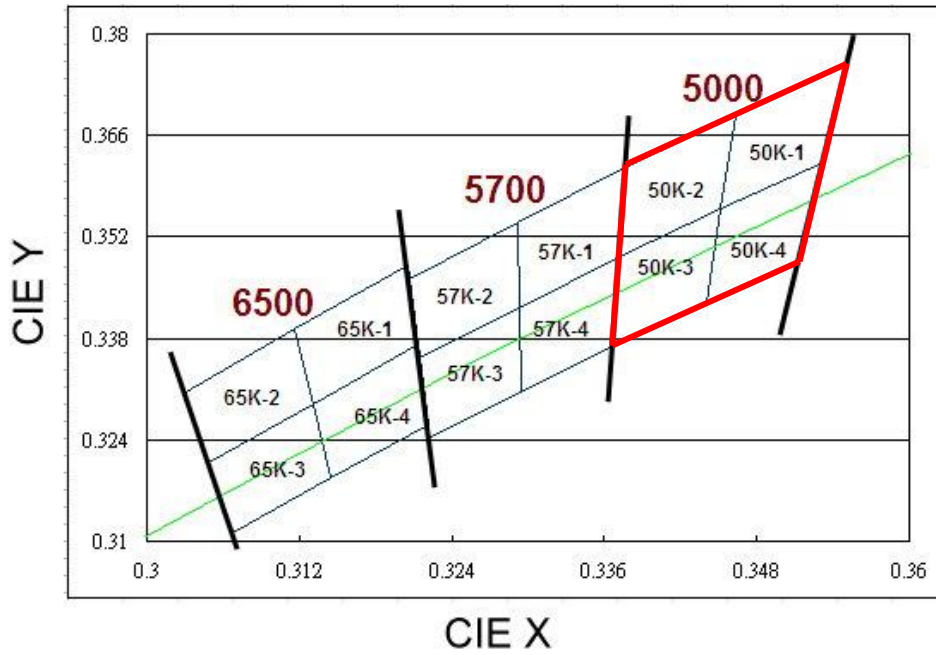

Cold White Bin Coordinates

5000K

Bin	CIE X	CIE Y
50K-1	0.355	0.376
	0.346	0.369
	0.345	0.356
	0.353	0.362
Reference Range: K		

Bin	CIE X	CIE Y
50K-2	0.346	0.369
	0.338	0.362
	0.337	0.349
	0.345	0.356
Reference Range: K		

Bin	CIE X	CIE Y
50K-4	0.353	0.362
	0.345	0.356
	0.344	0.343
	0.352	0.349
Reference Range: K		

Bin	CIE X	CIE Y
50K-3	0.345	0.356
	0.337	0.349
	0.337	0.337
	0.344	0.343
Reference Range:K		

Notes:

1. Color coordinates measurement allowance : ± 0.01

Forward Voltage Bins

Bin	Minimum Forward Voltage (V)	Maximum Forward Voltage (V)
T3	18.0	19.5
T4	19.5	21.0
T5	21.0	22.5
T6	22.5	24.0
T7	24.0	24.5

Notes:

1. Forward voltage measurement tolerance: $\pm 1V$

Pad Configuration

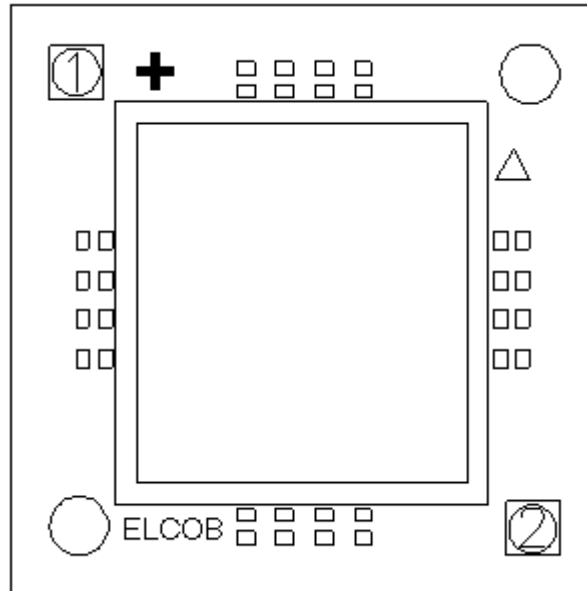

PAD	FUNCTION
1	ANODE
2	CATHODE

6.4W COB Typical Electro-Optical Characteristic Curve

Relative Spectral Distribution
@ Substrate Temperature = 25°C

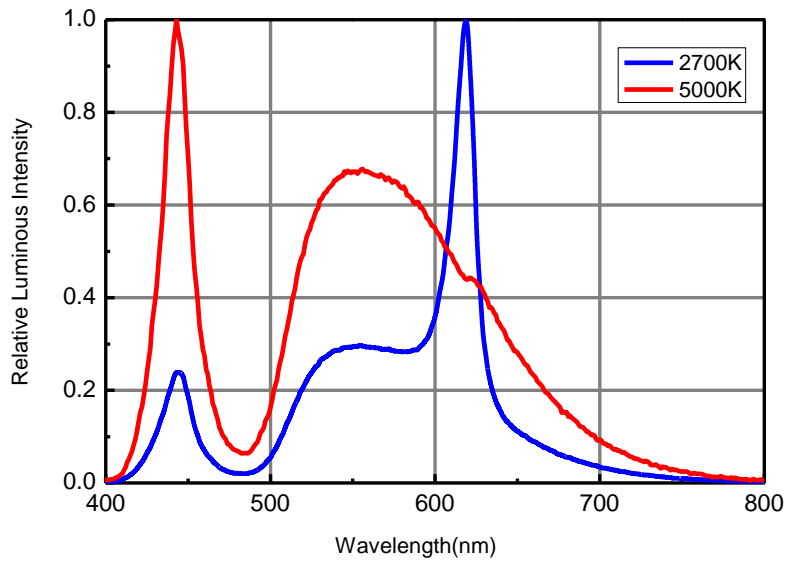

Relative Luminous Flux vs. Substrate Temperature
@ Forward Current = 300mA

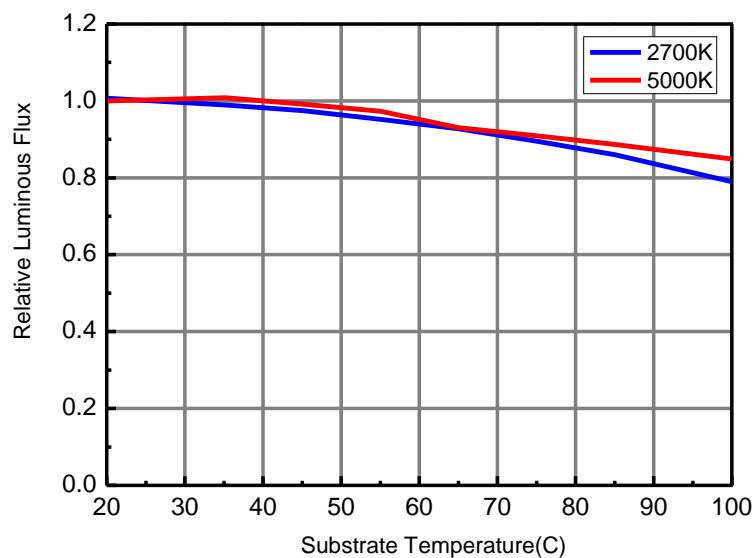

Forward Voltage vs. Forward Current @ Substrate Temperature = 25°C

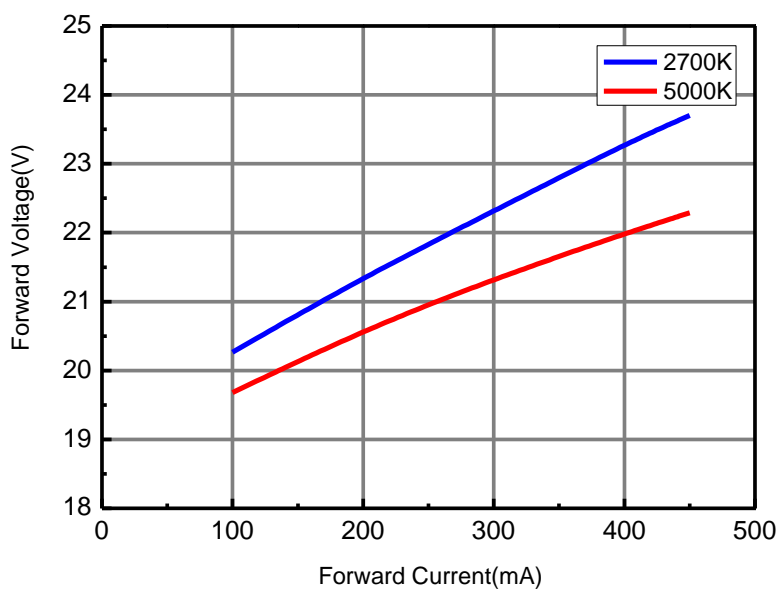

Relative Luminous Flux vs. Forward Current @ Substrate Temperature = 25°C

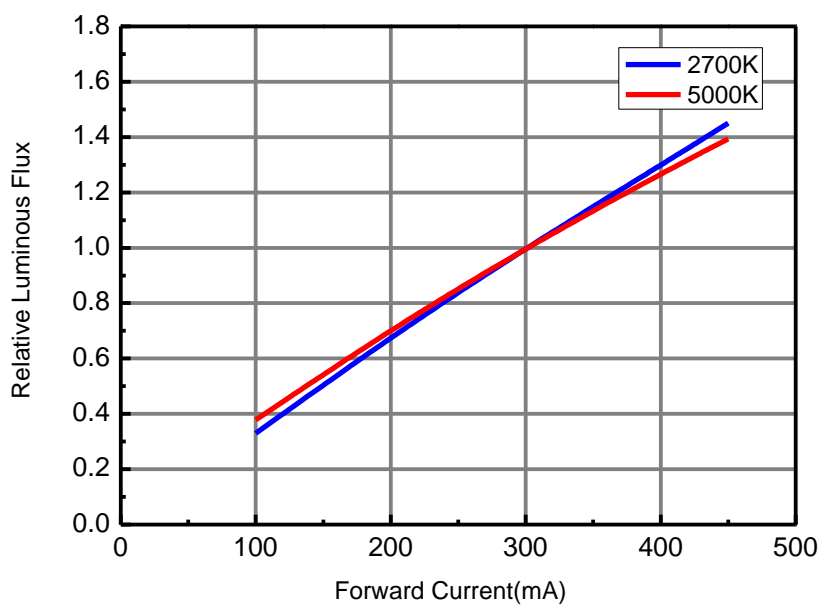

Correlated Color Temperature vs. Forward Current @ Substrate Temperature = 25°C

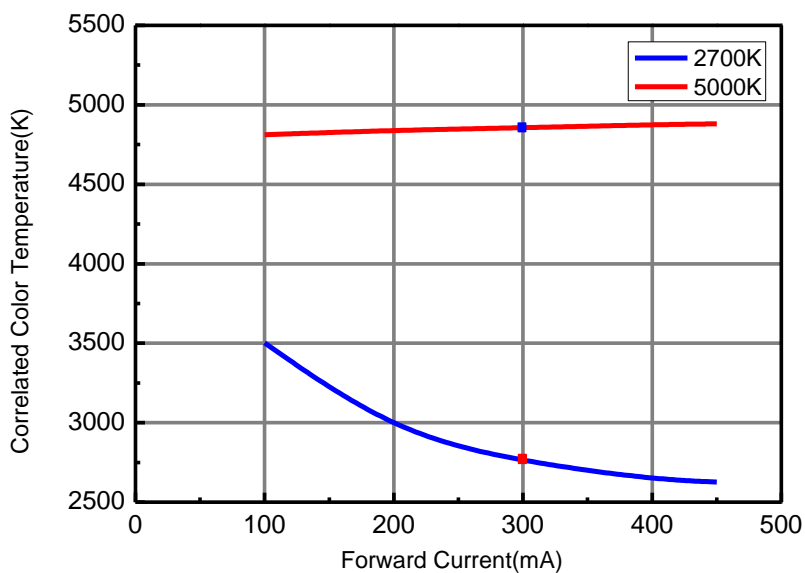

Color Coordinate vs. Substrate Temperature @ Forward Current = 300mA

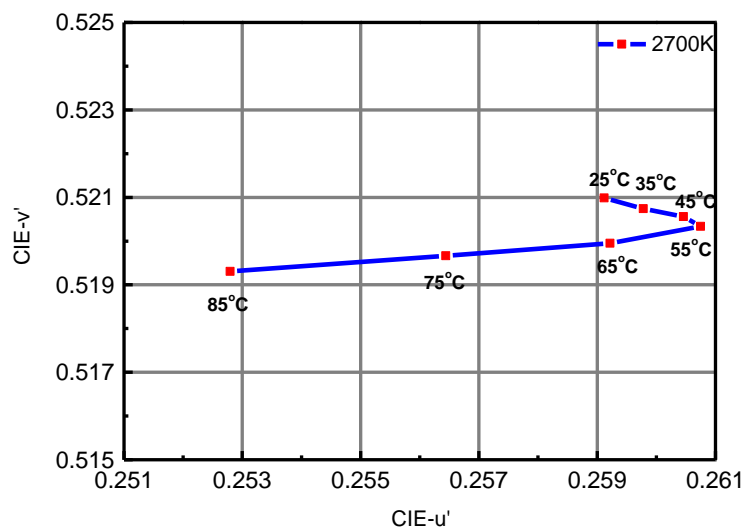

Correlated Color Temperature vs. Substrate Temperature @ Forward Current = 300mA

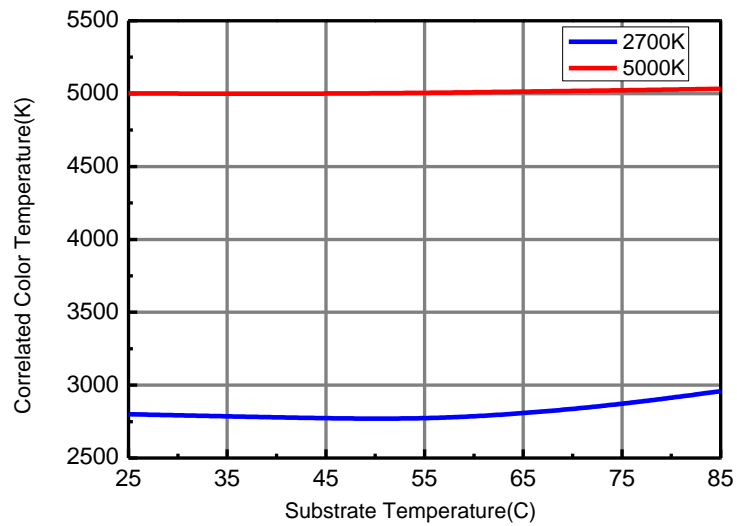

Typical Diagram Characteristics of Radiation Patterns

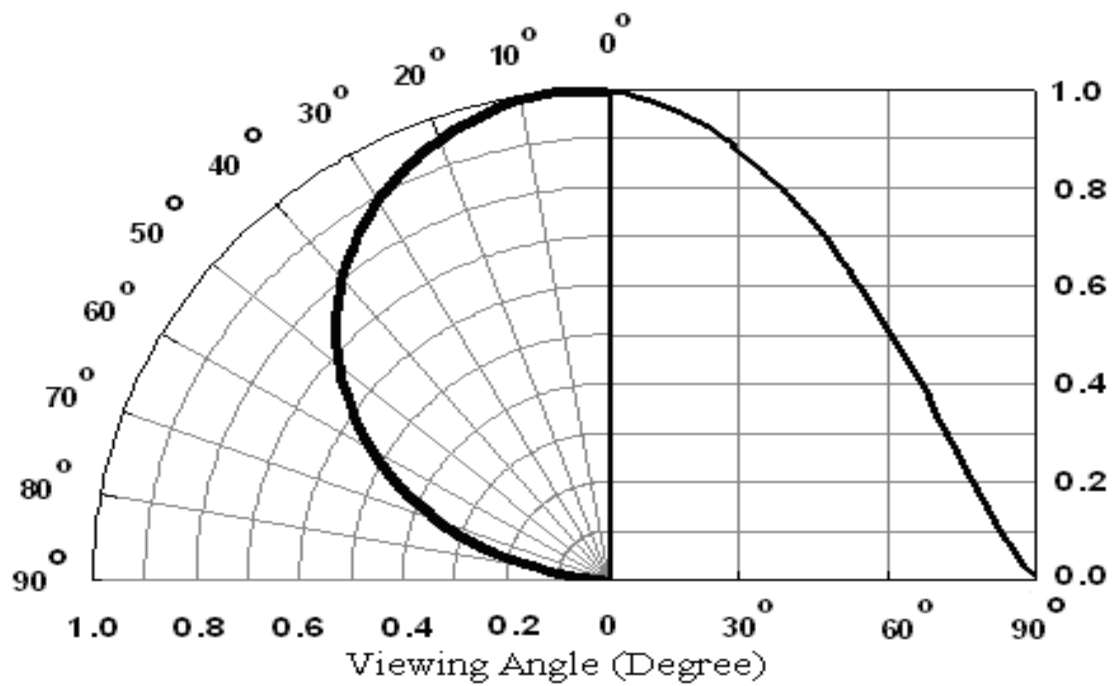

Notes:

1. $2\theta_{1/2}$ is the off axis angle from lamp centerline where the luminous intensity is 1/2 of the peak value.
2. Viewing angle tolerance is $\pm 5^\circ$.

Product Labeling

Label Explanation

CPN: Customer Specification (when required)

P/N : Everlight Production Number

QTY: Packing Quantity

CAT: Luminous Flux (Brightness) Bin

HUE: Color Bin

REF: Forward Voltage Bin

LOT No: Lot Number

MADE IN TAIWAN: Production Place



Carrier Tray Specification

Loaded Quantity:30 PCS Per Tray

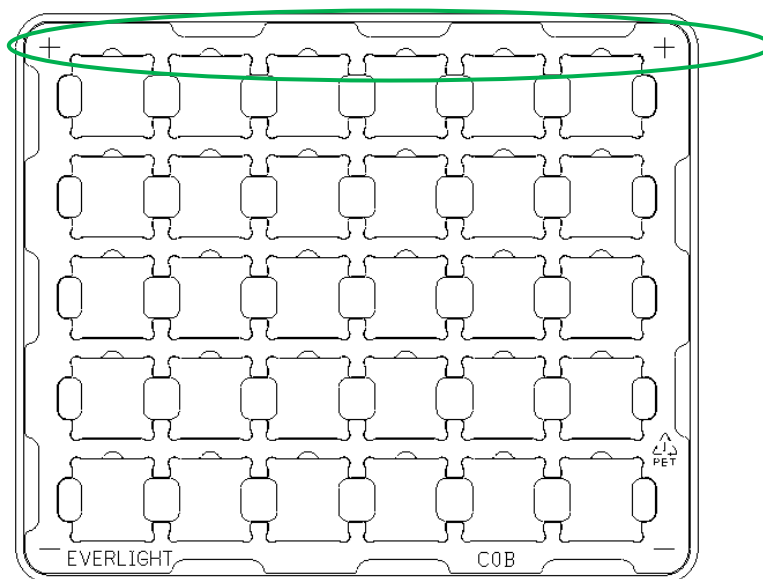
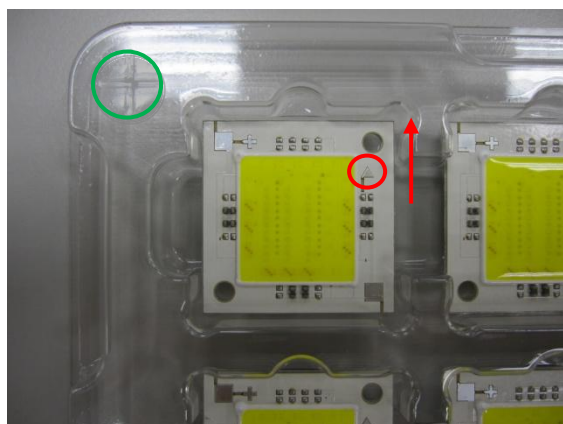

LED Direction

- The **triangle mark** on the LEDs will be toward the **Anode mark** on the carrier tray.

Outside Carton

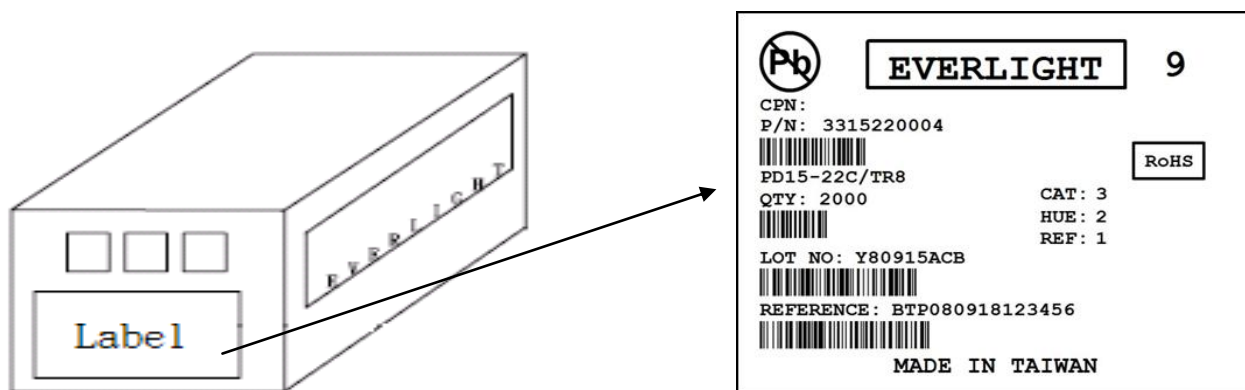

Packaging Quantity

- 30 PCS Per Tray
- 10 Trays Per Outside Carton

Recommended Installation Screw Pitch

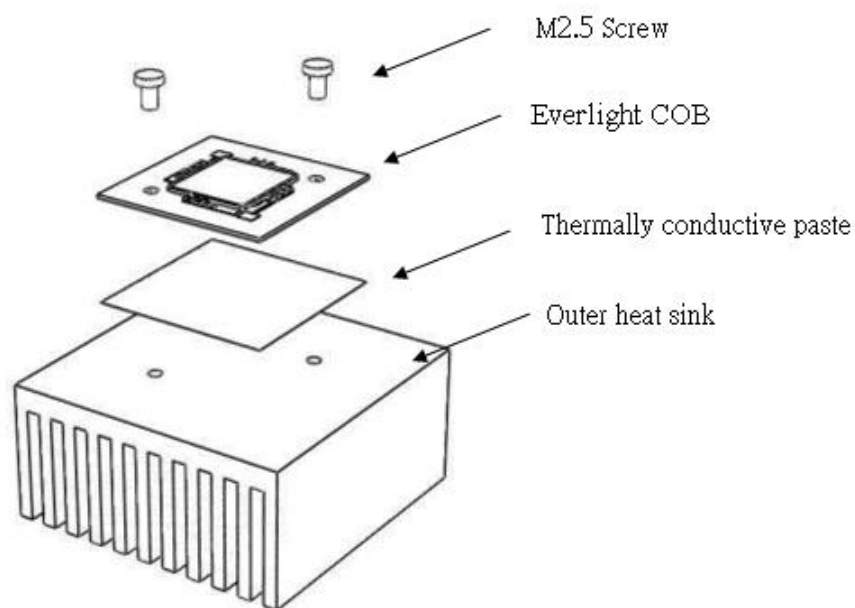

Precautions of Use

Over-Current-Proof

- Though the Everlight COB has a conducted ESD protection mechanism, customers must not use the device in reverse and should apply resistors for extra protection. Otherwise slight voltage shift may cause significant current changes and bum out failure may happen.

Storage

- Before the package is opened. The LEDs should be stored at 30°C or less and 50%RH or less after being shipped from Everlight and the storage life limits are 6 months. If the LEDs are stored for 6 months or more, they should be stored in a sealed container with a nitrogen atmosphere and moisture absorbent material.
- After opening the package: The LED's should be stored under 30°C or less and 30%RH or less. The LED should be used with 168hrs (7days) after opening the package. If unused LEDs remain, it should be stored in moisture proof packages.
- Do not stack assemblies containing Everlight COB LEDs so that anything stacks on the optical surface of LEDs. Forces applied to the optical surface may result in the surface being damaged.



Handling

- Don not putting mechanical stress on the LED.
- Never touch the optical surface with finger or sharp object. The LED surface could be soiled or damaged, which could affect the optical performance of the LED.
- In low-humidity work environment, please keep handling the LEDs with appropriate ESD grounding.
- It is recommended to handle the LED with powder-less latex gloves.

Manual Handling

When handling the product, do not apply direct pressure on the optical surface.

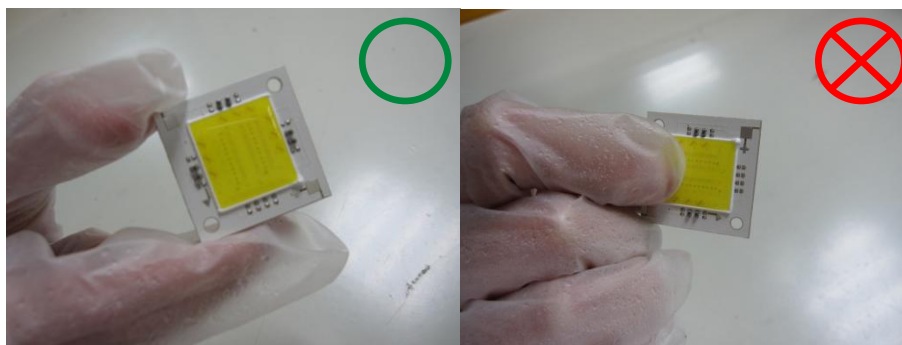

Do not touch the resin with tweezers to avoid scratching or other damage.

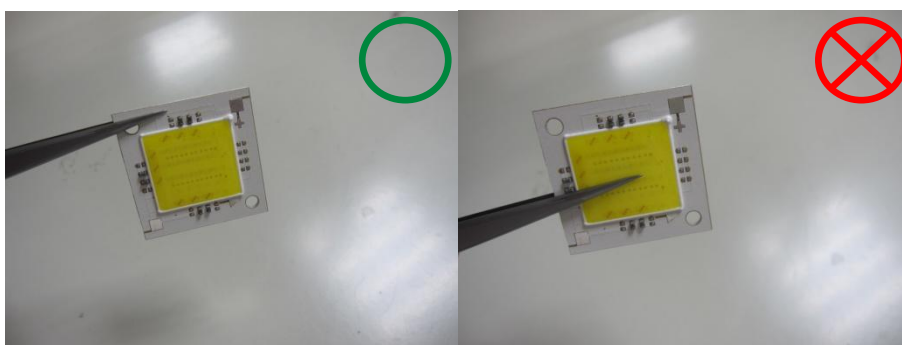

Thermal Management

- Sufficient thermal management must be implemented. The substrate temperature must be kept under 85°C at the driving current 300mA. Otherwise, the junction temperature of die may exceed over the limit at high current driving conditions and the LEDs' lifetime may be decrease dramatically.

Revision History

Current version: 12.27.2011

Issue No: DHE-0001714

Version: 2

Page	Subjects (major change in previous version)	Date of change
	Create new 6.4W 5000k	2011/12/27