

GPS Engine Board

with MTK Chipset

FGPMMOSL3

The document is the exclusive property of GlobalTop Tech Inc. and should not be distributed, reproduced, or any other format without prior permission of GlobalTop Tech Inc. Specifications subject to change without prior notice

GlobalTop Tech Inc.

No.16 Nan-ke 9th Rd, Science-Based Industrial Park, Tainan, 741, Taiwan, R.O.C.

Tel:+886-6-5051268 Fax:+886-6-5053381 <http://www.gtop-tech.com/> email: sales@gtop-tech.com

Copyright© 2009 GlobalTop Tech Inc. All right reserved.



FGPMMOSL3 Datasheet

A12

History		
Date	Rev.	Description
2007/05/09	A00	First Release
2007/05/25	A01	Add DC characteristics
		Modify Pin Description
2007/08/08	A02	Add Module Functional Block
		Modify Mechanical Outward
		Pin Description Updated
		Add GPS Antenna Specification(Recommended)
2007/09/11	A03	Module Functional Block Updated
2007/11/1	A04	Pin 9 Description Updated Module Functional Block Updated
2008/12/15	A05	Modify Operating Temperature Range
2009/3/24	A06	Modify DC Characteristics
2009/5/8	A07	Update Reflow Thermal Profile
2009/9/16	A08	Modify Dimension and PCB Footprint drawing
2010/02/03	A09	Add description about external antenna current limit.
2010/03/23	A10	Add Packing and Handling Section, plus SMT and soldering cautions
2010/4/30	A11	Page17: Modify for RMC Magnetic Variation data
2011/05/13	A12	Update company contact information

The document is the exclusive property of GlobalTop Tech Inc. and should not be distributed, reproduced, or any other format without prior permission of GlobalTop Tech Inc. Specifications subject to change without prior notice

GlobalTop Tech Inc.

No.16 Nan-ke 9th Rd, Science-Based Industrial Park, Tainan, 741, Taiwan, R.O.C.
Tel:+886-6-5051268 Fax:+886-6-5053381 <http://www.gtop-tech.com/> email: sales@gtop-tech.com
Copyright© 2009 GlobalTop Tech Inc. All right reserved.



FGPMMOSL3 Datasheet

A12

Description

The FGPMMOSL3 is a miniature GPS module. It is a GPS receiver which provides a solution that is high in position and speed accuracy performances, as well as being highly sensitive with excellent tracking capabilities in urban conditions. This mini module is extremely small in size (**only 11.5mm x 13mm area**). The GPS chipset inside this module is designed by **MediaTek Inc.**, the world's leading digital media solution provider and the largest fab-less IC Company in Taiwan. This module can support up to **51 channels**, and delivers major advancements in GPS performances, accuracy, integration, computing power and flexibility over its predecessors. It is designed to simplify the embedded system integration process.

Features

- ✿ Based on **MediaTek Single Chip** Architecture
- ✿ Dimension:**11.5mm x 13mm x 1.9mm**
- ✿ Low power consumption:**55mA typical @ acquisition, 39mA typical @ tracking**
- ✿ L1 Frequency, C/A code, **51-channel**
- ✿ High Sensitivity:Up to -158 dBm tracking, superior urban performances¹
- ✿ Position Accuracy:Without aid: 3m 2D-RMS
DGPS(RTM,SBAS(WAAS,EGNOS,MASA)):2.5m 2D-RMS
- ✿ Cold Start is Under 36 seconds (Typical)¹
- ✿ Warm Start is Under 33 seconds (Typical)¹
- ✿ Hot Start is under 1 second (Typical)¹
- ✿ Data Output Baud Rate:9600 bps
- ✿ Max. Update Rate: 5Hz
- ✿ RoHS Compliant

¹ Reference to GPS chipset specification

DGPS(RTM,SBAS(WAAS,EGNOS,MSAS)):2.5m 2D-RMS

The document is the exclusive property of GlobalTop Tech Inc. and should not be distributed, reproduced, or any other format without prior permission of GlobalTop Tech Inc. Specifications subject to change without prior notice

GlobalTop Tech Inc.

No.16 Nan-ke 9th Rd, Science-Based Industrial Park, Tainan, 741, Taiwan, R.O.C.

Tel:+886-6-5051268 Fax:+886-6-5053381 <http://www.gtop-tech.com/> email: sales@gtop-tech.com

Copyright© 2009 GlobalTop Tech Inc. All right reserved.



FGPMMOSL3 Datasheet

A12

Module Functional Block

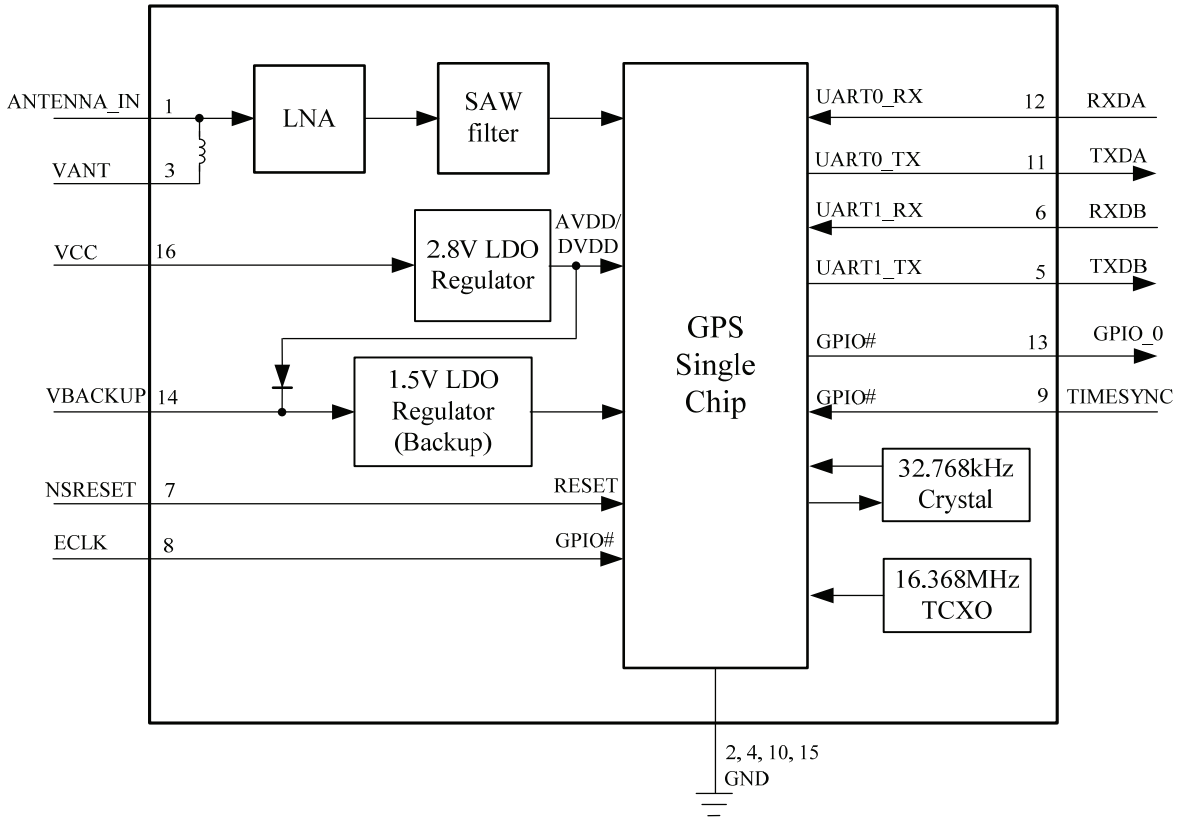

The document is the exclusive property of GlobalTop Tech Inc. and should not be distributed, reproduced, or any other format without prior permission of GlobalTop Tech Inc. Specifications subject to change without prior notice

GlobalTop Tech Inc.

No.16 Nan-ke 9th Rd, Science-Based Industrial Park, Tainan, 741, Taiwan, R.O.C.
 Tel:+886-6-5051268 Fax:+886-6-5053381 <http://www.gtop-tech.com/> email: sales@gtop-tech.com
 Copyright© 2009 GlobalTop Tech Inc. All right reserved.



FGPMMOSL3 Datasheet

A12

Mechanical

Dimension:(Unit : mm ; Tolerance : +/- 0.1mm)

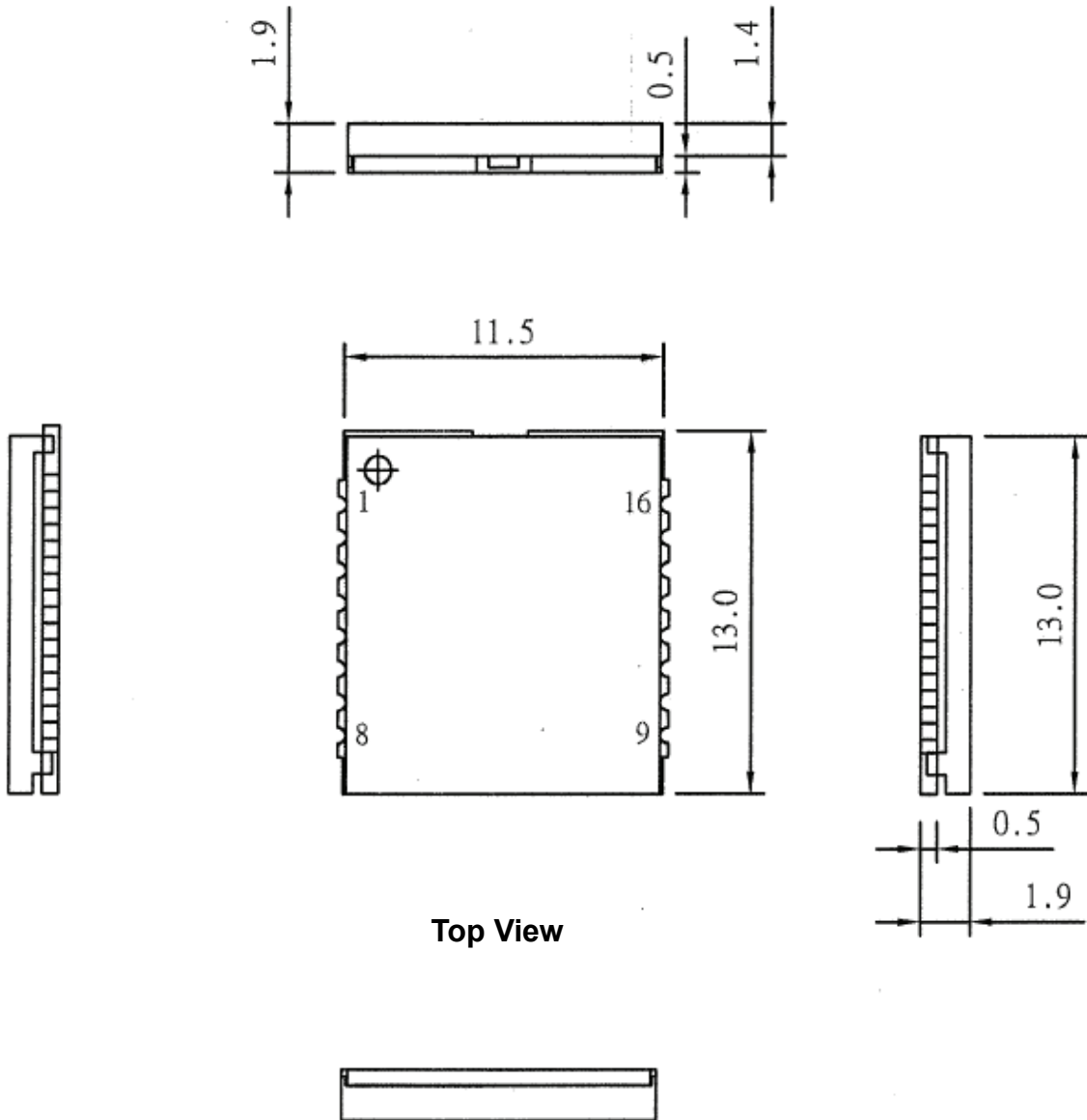

Top View

The document is the exclusive property of GlobalTop Tech Inc. and should not be distributed, reproduced, or any other format without prior permission of GlobalTop Tech Inc. Specifications subject to change without prior notice

GlobalTop Tech Inc.

No.16 Nan-ke 9th Rd, Science-Based Industrial Park, Tainan, 741, Taiwan, R.O.C.
Tel:+886-6-5051268 Fax:+886-6-5053381 <http://www.gtop-tech.com/> email: sales@gtop-tech.com
Copyright© 2009 GlobalTop Tech Inc. All right reserved.

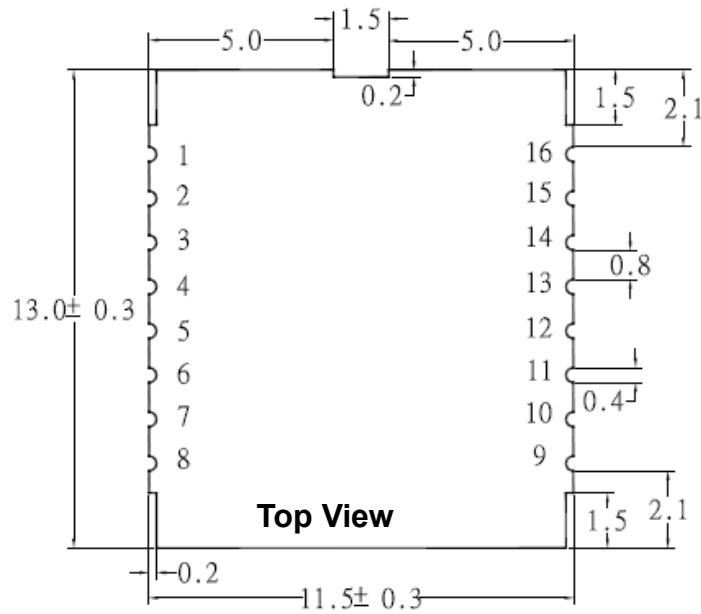

PCB Footprint:(Unit : mm ; Tolerance : +/- 0.1mm)

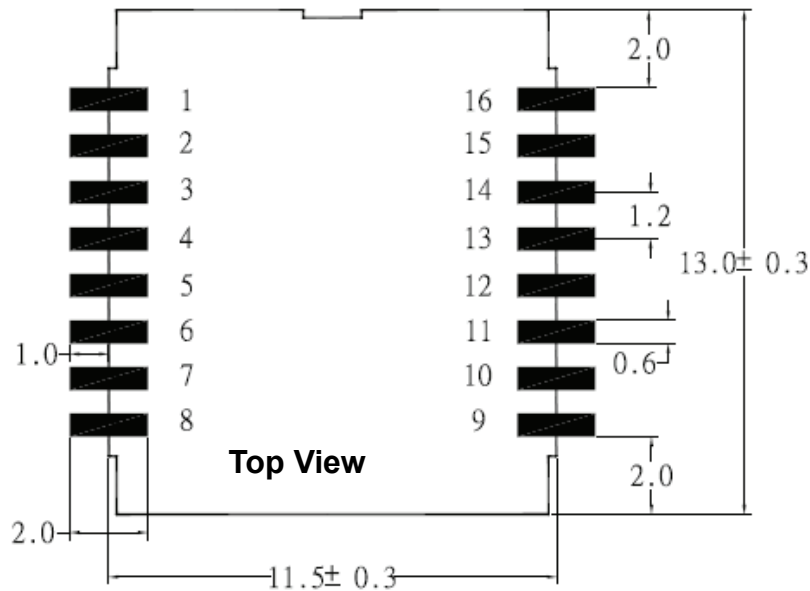

The document is the exclusive property of GlobalTop Tech Inc. and should not be distributed, reproduced, or any other format without prior permission of GlobalTop Tech Inc. Specifications subject to change without prior notice

GlobalTop Tech Inc.

No.16 Nan-ke 9th Rd, Science-Based Industrial Park, Tainan, 741, Taiwan, R.O.C.
 Tel:+886-6-5051268 Fax:+886-6-5053381 <http://www.gtop-tech.com/> email: sales@gtop-tech.com
 Copyright© 2009 GlobalTop Tech Inc. All right reserved.



FGPMMOSL3 Datasheet

A12

Pin Configuration

Pin	Name	I/O	Description
1	ANTENNA_IN	I	Antenna Signal Input
2	GND	P	Ground
3	VANT	PI	External Antenna Power Supply Input
4	GND	P	Ground
5	TXDB	O	Serial Data Output B
6	RXDB	I	Serial Data Input B
7	NSRESET	I	System Reset. Active low
8	ECLK	I	External Clock Input
9	TIMESYNC	I	External Time Synchronous Input
10	GND	P	Ground
11	TXDA	O	Serial Data Output A
12	RXDA	I	Serial Data Input A
13	GPIO_0	O	General Purpose I/O
14	VBACKUP	PI	RTC Backup Power Input
15	GND	P	Ground
16	VCC	P	DC Power Supply Input

The document is the exclusive property of GlobalTop Tech Inc. and should not be distributed, reproduced, or any other format without prior permission of GlobalTop Tech Inc. Specifications subject to change without prior notice

GlobalTop Tech Inc.

No.16 Nan-ke 9th Rd, Science-Based Industrial Park, Tainan, 741, Taiwan, R.O.C.

Tel:+886-6-5051268 Fax:+886-6-5053381 <http://www.gtop-tech.com/> email: sales@gtop-tech.com

Copyright© 2009 GlobalTop Tech Inc. All right reserved.



FGPMMOSL3 Datasheet

A12

Description of I/O Pin

ANTENNA_IN (Pin1)

GPS RF signal input. With the power supply from pin3 VANT, this pin can output a DC voltage for external active antenna.

GND (Pin2, 4, 10, 15)

The ground of the module

VANT (Pin3)

The power supply input for external active antenna should be kept from 2.5V to 5V. **The maximum consumption current for the GPS antenna is limited to 30mA.**

TXDB (Pin5)

This is the UART-A transmitter of the module. It is used for aiding. If not used, keep floating.

RXDB (Pin6)

This is the UART-A receiver of the module. It is used for aiding. If not used, keep floating.

NSRESET (Pin7)

With a low level, it causes the module to reset. If not used, keep floating.

ECLK (Pin8)

This pin is used for clock correcting in AGPS. Not used, keep floating.

TIMESYNC (Pin9)

This pin is used for time transfer information into the GPS receiver with AGPS code ONLY. Not used, keep floating.

The document is the exclusive property of GlobalTop Tech Inc. and should not be distributed, reproduced, or any other format without prior permission of GlobalTop Tech Inc. Specifications subject to change without prior notice

GlobalTop Tech Inc.

No.16 Nan-ke 9th Rd, Science-Based Industrial Park, Tainan, 741, Taiwan, R.O.C.

Tel:+886-6-5051268 Fax:+886-6-5053381 <http://www.gtop-tech.com/> email: sales@gtop-tech.com

Copyright© 2009 GlobalTop Tech Inc. All right reserved.



FGPMMOSL3 Datasheet

A12

TXDA (Pin11)

This is the UART transmitter of the module. It outputs the GPS information for application.

RXDA (Pin12)

This is the UART receiver of the module. It is used to receive software commands and firmware update.

GPIO_0 (Pin13)

The GPIO_0 was assigned as fix flag output. If not used, keep floating.

■ Before 2D Fix

The GPIO_A should continuously output one-second high-level with one-second low-level signal.

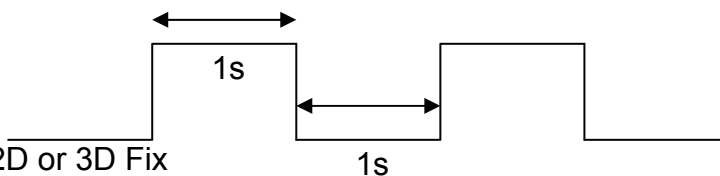

■ After 2D or 3D Fix

The GPIO_A should continuously output low-level signal.

Low _____

VBACKUP (Pin14)

This is the backup power for GPS chipset to keep RTC running when main power is removed. For normal operation, the input voltage must be kept from 1.8V to 5.5V. **To use the function related to VBackup, this pin must be connected to a power supply.**

VCC (Pin16)

The main DC power supply for the module. The voltage should be kept between from 3.0V to 5.5V.

The document is the exclusive property of GlobalTop Tech Inc. and should not be distributed, reproduced, or any other format without prior permission of GlobalTop Tech Inc. Specifications subject to change without prior notice

GlobalTop Tech Inc.

No.16 Nan-ke 9th Rd, Science-Based Industrial Park, Tainan, 741, Taiwan, R.O.C.

Tel:+886-6-5051268 Fax:+886-6-5053381 <http://www.gtop-tech.com/> email: sales@gtop-tech.com

Copyright© 2009 GlobalTop Tech Inc. All right reserved.



FGPMMOSL3 Datasheet

A12

Specifications

General	
Chipset	MTK MT3318
Frequency	L1, 1575.42MHz
C/A Code	1.023 MHz
Channels	51 channels
DGPS	RTCM protocol WAAS, EGNOS, MSAS
Datum	WGS84(Default), Tokyo-M, Tokyo-A, User Define
CPU	ARM7TDMI
Dimensions	
Length/Width/Height	11.5*13*1.9mm
Weight	2g
Performance Characteristics	
Position Accuracy	Without aid: 3m 2D-RMS
	DGPS(RTM,SBAS(WAAS,EGNOS,MASA)):2.5m 2D-RMS
Velocity Accuracy	Without aid:0.1 m/s
	DGPS (RTCM, SBAS (WAAS, EGNOS, MSAS)):0.05m/s
Acceleration	Without aid:< 4g
	DGPS (RTCM, SBAS (WAAS, EGNOS, MSAS)):< 4g
Timing Accuracy	100 ns RMS
Sensitivity ¹	Acquisition:-146dBm (Cold Start)
	Reacquisition:-156dBm
	Tracking:-158dBm
Maximum Update Rate	5Hz
Acquisition (Open sky, stationary)	
Reacquisition Time ¹	Less than 1 second
Hot start ¹	1 second (Typical)
Warm start ¹	33 seconds (Typical)
Cold start ¹	36 seconds (Typical)

The document is the exclusive property of GlobalTop Tech Inc. and should not be distributed, reproduced, or any other format without prior permission of GlobalTop Tech Inc. Specifications subject to change without prior notice

GlobalTop Tech Inc.

No.16 Nan-ke 9th Rd, Science-Based Industrial Park, Tainan, 741, Taiwan, R.O.C.

Tel:+886-6-5051268 Fax:+886-6-5053381 <http://www.gtop-tech.com/> email: sales@gtop-tech.com

Copyright© 2009 GlobalTop Tech Inc. All right reserved.



FGPMMOSL3 Datasheet

A12

Dynamic	
Altitude	Maximum 18,000m
Velocity	Maximum 515m/s
Acceleration	Maximum 4g
I/O	
Signal Output	8 data bits, no parity, 1 stop bit
Available Baud Rates	9600 bps (4800/14400/19200/38400/57600/115200 is also available)
Protocols	NMEA 0183 v3.01 (Default:GGA,GSA,GSV,RMC,VTG) RTCM MTK NMEA Command Network Assistance Messages
Data output Interface	
Protocol messages	9600 bps/8/N/1 (Default)
Output format	GGA(1sec),GSA(1sec),RMC(1sec),VTG(1sec), GSV(5sec) (Default)
Environment	
Operating Temperature	-40 °C to 85 °C
Storage Temperature	-50 °C to 90 °C
Operating Humidity	5% to 95% (no condensing)

¹ Reference to GPS chipset specification

The document is the exclusive property of GlobalTop Tech Inc. and should not be distributed, reproduced, or any other format without prior permission of GlobalTop Tech Inc. Specifications subject to change without prior notice

GlobalTop Tech Inc.

No.16 Nan-ke 9th Rd, Science-Based Industrial Park, Tainan, 741, Taiwan, R.O.C.
Tel:+886-6-5051268 Fax:+886-6-5053381 <http://www.gtop-tech.com/> email: sales@gtop-tech.com
Copyright© 2009 GlobalTop Tech Inc. All right reserved.



FGPMMOSL3 Datasheet

A12

DC Characteristics

Parameter	Condition	Min.	Typ.	Max.	Unit
Operation supply Voltage	—	3.0	3.3	5.5	V
Backup Voltage	—	1.8	3.3	5.5	V
Operation supply Ripple Voltage	—	—	—	50	mVpp
RXA TTL H Level	VCC=3.3V	2.1	—	2.8	V
RXA TTL L Level	VCC=3.3V	0	—	0.9	V
TXA TTL H Level	VCC=3.3V	2.1	—	2.8	V
TXA TTL L Level	VCC=3.3V	0	—	0.8	V
Power Consumption @ 5.0V	Acquisition	51	56	61	mA
	Tracking	35	40	45	mA
Power Consumption @ 3.3V	Acquisition	50	55	60	mA
	Tracking	34	39	44	mA
Backup Power Consumption @ 3.3V	25 °C	—	10	—	uA

GPS External Antenna Specification (Recommended)

It is important that the antenna gets a clear view of the sky and is positioned on a surface level to the horizon for best results. The following specification has to meet for the use reference design.

Characteristic	Specification
Polarization	Right-hand circular polarized
Receive frequency	1.57542GHz +/-1.023MHz
Power supply	2.8V
DC current	<30mA at 2.8V
Total gain	+15dBi
Output VSWR	<2.5
Impedance	50ohm
Noise Figure	<1.5dB

The document is the exclusive property of GlobalTop Tech Inc. and should not be distributed, reproduced, or any other format without prior permission of GlobalTop Tech Inc. Specifications subject to change without prior notice

GlobalTop Tech Inc.

No.16 Nan-ke 9th Rd, Science-Based Industrial Park, Tainan, 741, Taiwan, R.O.C.

Tel:+886-6-5051268 Fax:+886-6-5053381 <http://www.gtop-tech.com/> email: sales@gtop-tech.com

Copyright© 2009 GlobalTop Tech Inc. All right reserved.



FGPMMOSL3 Datasheet

A12

NMEA Output Sentence

Table-1 lists each of the NMEA output sentences specifically developed and defined by MTK for use within MTK products

NMEA Output Sentence		Table-1
Option	Description	
GGA	Time, position and fix type data.	
GSA	GPS receiver operating mode, active satellites used in the position solution, and DOP values.	
GSV	The number of GPS satellites in view satellite ID numbers, elevation, azimuth, and SNR values.	
RMC	Time, date, position, course and speed data. Recommended Minimum Navigation Information.	
VTG	Course and speed information relative to the ground.	

The document is the exclusive property of GlobalTop Tech Inc. and should not be distributed, reproduced, or any other format without prior permission of GlobalTop Tech Inc. Specifications subject to change without prior notice

GlobalTop Tech Inc.

No.16 Nan-ke 9th Rd, Science-Based Industrial Park, Tainan, 741, Taiwan, R.O.C.
Tel:+886-6-5051268 Fax:+886-6-5053381 <http://www.gtop-tech.com/> email: sales@gtop-tech.com
Copyright© 2009 GlobalTop Tech Inc. All right reserved.



FGPMMOSL3 Datasheet

A12

GGA—Global Positioning System Fixed Data. Time, Position and fix related data for a GPS receiver

Table-2 contains the values for the following example:

\$GPGGA,064951.000,2307.125647,N,12016.443856,E,1,8,0.95,39.944,M,17.806,M,,*65

GGA Data Format			Table-2
Name	Example	Units	Description
Message ID	\$GPGGA		GGA protocol header
UTC Time	064951.000		hhmmss.sss
Latitude	2307.125647		ddmm.mmmmmm
N/S Indicator	N		N=north or S=south
Longitude	12016.443856		dddmm.mmmmmm
E/W Indicator	E		E=east or W=west
Position Fix Indicator	1		See Table-3
Satellites Used	8		Range 0 to 14
HDOP	0.95		Horizontal Dilution of Precision
MSL Altitude	39.944	meters	Antenna Altitude above/below mean-sae-level
Units	M	meters	Units of antenna altitude
Geoidal Separation	17.806	meters	
Units	M	meters	Units of geoidal separation
Age of Diff. Corr.		second	Null fields when DGPS is not used
Checksum	*65		
<CR> <LF>			End of message termination

Position Fix Indicator		Table-3
Value	Description	
0	Fix not available	
1	GPS fix	
2	Differential GPS fix	

The document is the exclusive property of GlobalTop Tech Inc. and should not be distributed, reproduced, or any other format without prior permission of GlobalTop Tech Inc. Specifications subject to change without prior notice

GlobalTop Tech Inc.

No.16 Nan-ke 9th Rd, Science-Based Industrial Park, Tainan, 741, Taiwan, R.O.C.
 Tel:+886-6-5051268 Fax:+886-6-5053381 <http://www.gtop-tech.com/> email: sales@gtop-tech.com
 Copyright© 2009 GlobalTop Tech Inc. All right reserved.



FGPMMOSL3 Datasheet

A12

GSA—GNSS DOP and Active Satellites

Table-4 contains the values for the following example:

\$GPGSA,A,3,29,21,26,15,18,09,06,10,,,,,2.32,0.95,2.11*00

GSA Data Format			Table-4
Name	Example	Units	Description
Message ID	\$GPGSA		GSA protocol header
Mode 1	A		See Table-5
Mode 2	3		See Table-6
Satellite Used	29		SV on Channel 1
Satellite Used	21		SV on Channel 2
....
Satellite Used			SV on Channel 12
PDOP	2.32		Position Dilution of Precision
HDOP	0.95		Horizontal Dilution of Precision
VDOP	2.11		Vertical Dilution of Precision
Checksum	*00		
<CR> <LF>			End of message termination

Mode 1		Table-5
Value	Description	
M	Manual—forced to operate in 2D or 3D mode	
A	2D Automatic—allowed to automatically switch 2D/3D	

Mode 2		Table-6
Value	Description	
1	Fix not available	
2	2D (< 4 SVs used)	
3	3D (\geq 4 SVs used)	

The document is the exclusive property of GlobalTop Tech Inc. and should not be distributed, reproduced, or any other format without prior permission of GlobalTop Tech Inc. Specifications subject to change without prior notice

GlobalTop Tech Inc.

No.16 Nan-ke 9th Rd, Science-Based Industrial Park, Tainan, 741, Taiwan, R.O.C.
 Tel:+886-6-5051268 Fax:+886-6-5053381 <http://www.gtop-tech.com/> email: sales@gtop-tech.com
 Copyright© 2009 GlobalTop Tech Inc. All right reserved.



FGPMMOSL3 Datasheet

A12

GSV—GNSS Satellites in View

Table-7 contains the values for the following example:

\$GPGSV,3,1,09,29,36,029,42,21,46,314,43,26,44,020,43,15,21,321,39*7D

\$GPGSV,3,2,09,18,26,314,40,09,57,170,44,06,20,229,37,10,26,084,37*77

\$GPGSV,3,3,09,07,,,26*73

GSV Data Format			Table-7
Name	Example	Units	Description
Message ID	\$GPGSV		GSV protocol header
Number of Messages	3		Range 1 to 3 <i>(Depending on the number of satellites tracked, multiple messages of GSV data may be required.)</i>
Message Number1	1		Range 1 to 3
Satellites in View	09		
Satellite ID	29		Channel 1 (Range 1 to 32)
Elevation	36	degrees	Channel 1 (Maximum 90)
Azimuth	029	degrees	Channel 1 (True, Range 0 to 359)
SNR (C/No)	42	dBHz	Range 0 to 99, (null when not tracking)
....
Satellite ID	15		Channel 4 (Range 1 to 32)
Elevation	21	degrees	Channel 4 (Maximum 90)
Azimuth	321	degrees	Channel 4 (True, Range 0 to 359)
SNR (C/No)	39	dBHz	Range 0 to 99, (null when not tracking)
Checksum	*7D		
<CR> <LF>			End of message termination

The document is the exclusive property of GlobalTop Tech Inc. and should not be distributed, reproduced, or any other format without prior permission of GlobalTop Tech Inc. Specifications subject to change without prior notice

GlobalTop Tech Inc.

No.16 Nan-ke 9th Rd, Science-Based Industrial Park, Tainan, 741, Taiwan, R.O.C.

Tel:+886-6-5051268 Fax:+886-6-5053381 <http://www.gtop-tech.com/> email: sales@gtop-tech.com

Copyright© 2009 GlobalTop Tech Inc. All right reserved.



FGPMMOSL3 Datasheet

A12

RMC—Recommended Minimum Navigation Information

Table-8 contains the values for the following example:

\$GPRMC,064951.000,A,2307.125647,N,12016.443856,E,0.036,165.48,260406,3.05,M,A*2C

RMC Data Format		Table-8	
Name	Example	Units	Description
Message ID	\$GPRMC		RMC protocol header
UTC Time	064951.000		hhmmss.sss
Status	A		A=data valid or V=data not valid
Latitude	2307.125647		ddmm.mmmmmm
N/S Indicator	N		N=north or S=south
Longitude	12016.443856		dddmm.mmmmmm
E/W Indicator	E		E=east or W=west
Speed Over Ground	0.036	knots	
Course Over Ground	165.48	degrees	True
Date	260406		ddmmyy
Magnetic Variation	3.05, W	degrees	E=east or W=west (Need GlobalTop customization service)
Mode	A		A= Autonomous mode D= Differential mode E= Estimated mode
Checksum	*65		
<CR> <LF>			End of message termination

The document is the exclusive property of GlobalTop Tech Inc. and should not be distributed, reproduced, or any other format without prior permission of GlobalTop Tech Inc. Specifications subject to change without prior notice

GlobalTop Tech Inc.

No.16 Nan-ke 9th Rd, Science-Based Industrial Park, Tainan, 741, Taiwan, R.O.C.
Tel:+886-6-5051268 Fax:+886-6-5053381 <http://www.gtop-tech.com/> email: sales@gtop-tech.com
Copyright© 2009 GlobalTop Tech Inc. All right reserved.



FGPMMOSL3 Datasheet

A12

VTG — Course and speed information relative to the ground.

Table-9 contains the values for the following example:

\$GPVTG,165.48,T,,M,0.036,N,0.067,K,A*37

VTG Data Format			Table-9
Name	Example	Units	Description
Message ID	\$GPVTG		VTG protocol header
Course	165.48	degrees	Measured heading
Reference	T		True
Course		degrees	Measured heading
Reference	M		Magnetic (Need Global Top customization service.)
Speed	0.036	knots	Measured horizontal speed
Units	N		Knots
Speed	0.067	km/hr	Measured horizontal speed
Units	K		Kilometers per hour
Mode	A		A= Autonomous mode D= Differential mode E= Estimated mode
Checksum	*06		
<CR> <LF>			End of message termination

MTK NMEA Command Protocol

Packet Type:

103 PMTK_CMD_COLD_START

Packet Meaning:

Cold Start: Don't use Time, Position, Almanacs and Ephemeris data at re-start.

Example:

\$PMTK103*30<CR><LF>

The document is the exclusive property of GlobalTop Tech Inc. and should not be distributed, reproduced, or any other format without prior permission of GlobalTop Tech Inc. Specifications subject to change without prior notice

GlobalTop Tech Inc.

No.16 Nan-ke 9th Rd, Science-Based Industrial Park, Tainan, 741, Taiwan, R.O.C.
Tel:+886-6-5051268 Fax:+886-6-5053381 <http://www.gtop-tech.com/> email: sales@gtop-tech.com
Copyright© 2009 GlobalTop Tech Inc. All right reserved.



FGPMMOSL3 Datasheet

A12

Packing and Handling

GPS modules, like any other SMD devices, are sensitive to moisture, electrostatic discharge, and temperature. By following the standards outlined in this document for GlobalTop GPS module storage and handling, it is possible to reduce the chances of them being damaged during production set-up. This document will go through the basics on how GlobalTop packages its modules to ensure they arrive at their destination without any damages and deterioration to performance quality, as well as some cautionary notes before going through the surface mount process.

- ⚠ Please read the sections II to V carefully to avoid damages permanent damages due to moisture intake**

- ⚠ GPS receiver modules contain highly sensitive electronic circuits and are electronic sensitive devices and improper handling without ESD protections may lead to permanent damages to the modules. Please read section VI for more details.**

Moisture Sensitivity

GlobalTop GPS modules are moisture sensitive, and must be pre-baked before going through the solder reflow process. It is important to know that:

GlobalTop GPS modules must complete solder reflow process in 72 hours after pre-baking.

This maximum time is otherwise known as “Floor Life”

If the waiting time has exceeded 72 hours, it is possible for the module to suffer damages during the solder reflow process such as cracks and delamination of the SMD pads due to excess moisture pressure.

The document is the exclusive property of GlobalTop Tech Inc. and should not be distributed, reproduced, or any other format without prior permission of GlobalTop Tech Inc. Specifications subject to change without prior notice

GlobalTop Tech Inc.

No.16 Nan-ke 9th Rd, Science-Based Industrial Park, Tainan, 741, Taiwan, R.O.C.
Tel:+886-6-5051268 Fax:+886-6-5053381 <http://www.gtop-tech.com/> email: sales@gtop-tech.com
Copyright© 2009 GlobalTop Tech Inc. All right reserved.

Packing

GlobalTop GPS modules are packed in such a way to ensure the product arrives to SMD factory floor without any damages.

GPS modules are placed individually on to the packaging tray. The trays will then be stacked and packaged together.

Included are:

1. Two packs of desiccant for moisture absorption
2. One moisture level color coded card for relative humidity percentage.

Each package is then placed inside an antistatic bag (or PE bag) that prevents the modules from being damaged by electrostatic discharge.



Figure 1: One pack of GPS modules

Each bag is then carefully placed inside two levels of cardboard carton boxes for maximum protection.



Figure 2: Box protection

The document is the exclusive property of GlobalTop Tech Inc. and should not be distributed, reproduced, or any other format without prior permission of GlobalTop Tech Inc. Specifications subject to change without prior notice

GlobalTop Tech Inc.

No.16 Nan-ke 9th Rd, Science-Based Industrial Park, Tainan, 741, Taiwan, R.O.C.

Tel:+886-6-5051268 Fax:+886-6-5053381 <http://www.gtop-tech.com/> email: sales@gtop-tech.com

Copyright© 2009 GlobalTop Tech Inc. All right reserved.

The moisture color coded card provides an insight to the relative humidity percentage (RH). When the GPS modules are taken out, it should be around or lower than 30% RH level. Outside each electrostatic bag is a caution label for moisture sensitive device.

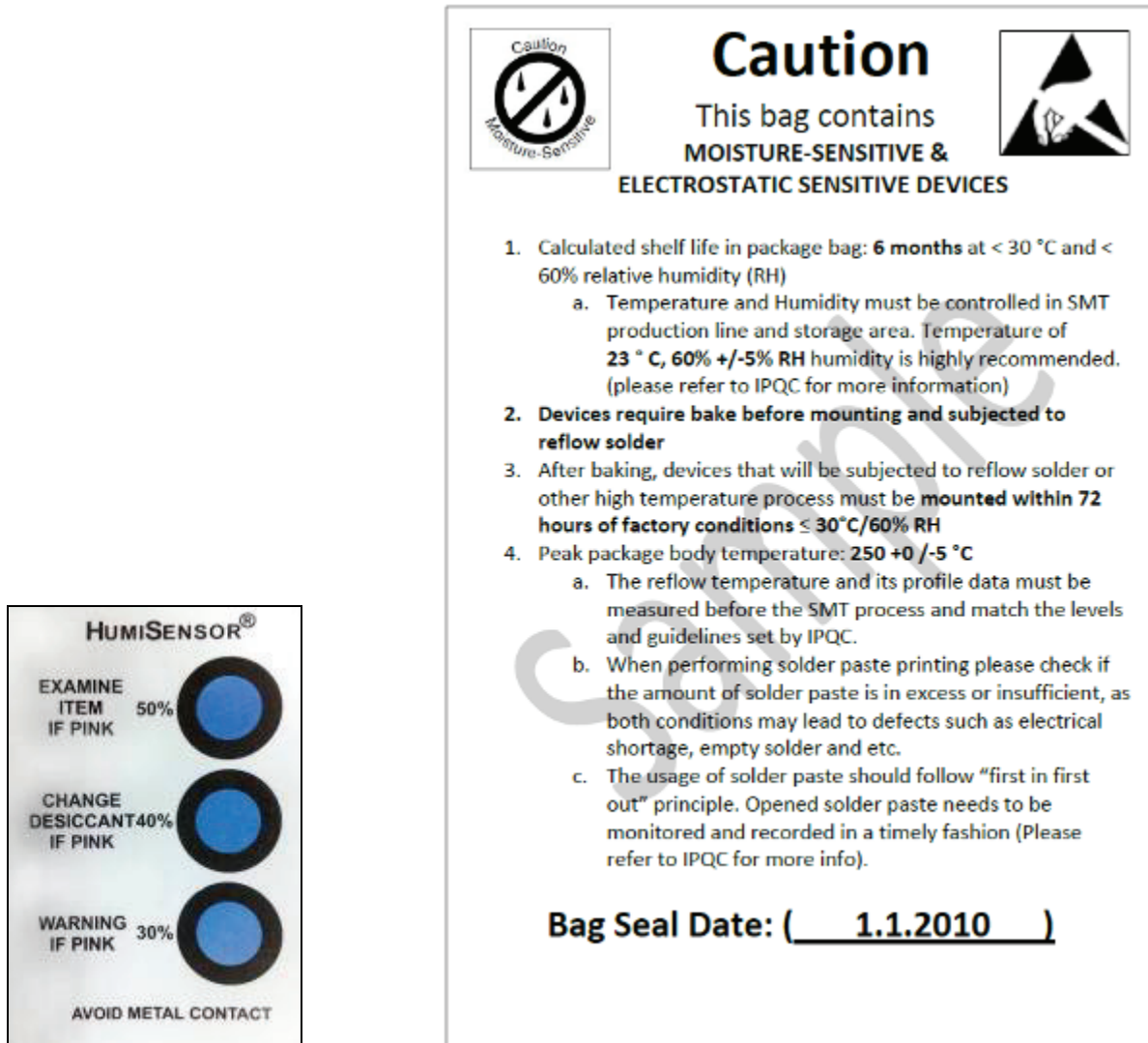

Figure 3: Example of moisture color coded card and caution label

The document is the exclusive property of GlobalTop Tech Inc. and should not be distributed, reproduced, or any other format without prior permission of GlobalTop Tech Inc. Specifications subject to change without prior notice

GlobalTop Tech Inc.

No.16 Nan-ke 9th Rd, Science-Based Industrial Park, Tainan, 741, Taiwan, R.O.C.
Tel:+886-6-5051268 Fax:+886-6-5053381 <http://www.gtop-tech.com/> email: sales@gtop-tech.com
Copyright© 2009 GlobalTop Tech Inc. All right reserved.



FGPMMOSL3 Datasheet

A12

Storage and Floor Life Guideline

Since GlobalTop modules must undergo solder-reflow process in 72 hours after it has gone through pre-baking procedure, therefore if it is not used by then, it is recommended to store the GPS modules in dry places such as dry cabinet.

The approximate shelf life for GlobalTop GPS modules packages is 6 months from the bag seal date, when store in a non-condensing storage environment (<30°C/60% RH)

⚠ It is important to note that it is a required process for GlobalTop GPS modules to undergo pre-baking procedures, regardless of the storage condition.

Drying

Because the vapor pressures of moisture inside the GPS modules increase greatly when it is exposed to high temperature of solder reflow, in order to prevent internal delaminating, cracking of the devices, or the “popcorn” phenomenon, it is a **necessary requirement** for GlobalTop GPS module to undergo pre-baking procedure before any high temperature or solder reflow process.

The recommendation baking time for GlobalTop GPS module is as follows:

- ✓ **60°C for 8 to 12 hours**

Once baked, the module’s floor life will be “reset”, and has additional 72 hours in normal factory condition to undergo solder reflow process.

⚠ Please limit the number of times the GPS modules undergoes baking processes as repeated baking process has an effect of reducing the wetting effectiveness of the SMD pad contacts. This applies to all SMT devices.

The document is the exclusive property of GlobalTop Tech Inc. and should not be distributed, reproduced, or any other format without prior permission of GlobalTop Tech Inc. Specifications subject to change without prior notice

GlobalTop Tech Inc.

No.16 Nan-ke 9th Rd, Science-Based Industrial Park, Tainan, 741, Taiwan, R.O.C.
Tel:+886-6-5051268 Fax:+886-6-5053381 <http://www.gtop-tech.com/> email: sales@gtop-tech.com
Copyright© 2009 GlobalTop Tech Inc. All right reserved.



FGPMMOSL3 Datasheet

A12

⚠ Oxidation Risk: Baking SMD packages may cause oxidation and/or intermetallic growth of the terminations, which if excessive can result in solderability problems during board assembly. The temperature and time for baking SMD packages are therefore limited by solderability considerations. The cumulative bake time at a temperature greater than 90°C and up to 125°C shall not exceed 96 hours. Bake temperatures higher than 125°C are now allowed.

ESD Handling



Please carefully follow the following precautions to prevent severe damage to GPS modules.

GlobalTop GPS modules are sensitive to electrostatic discharges, and thus are Electrostatic Sensitive Devices (ESD). Careful handling of the GPS modules and in particular to its patch antenna (if included) and RF_IN pin, must follow the standard ESD safety practices:

- ✓ Unless there is a galvanic coupling between the local GND and the PCB GND, then the first point of contact when handling the PCB shall always be between the local GND and PCB GND.
- ✓ Before working with RF_IN pin, please make sure the GND is connected
- ✓ When working with RF_IN pin, do not contact any charges capacitors or materials that can easily develop or store charges such as patch antenna, coax cable, soldering iron.
- ✓ Please do not touch the mounted patch antenna to prevent electrostatic discharge from the RF input
- ✓ When soldering RF_IN pin, please make sure to use an ESD safe soldering iron (tip).

The document is the exclusive property of GlobalTop Tech Inc. and should not be distributed, reproduced, or any other format without prior permission of GlobalTop Tech Inc. Specifications subject to change without prior notice

GlobalTop Tech Inc.

No.16 Nan-ke 9th Rd, Science-Based Industrial Park, Tainan, 741, Taiwan, R.O.C.
Tel:+886-6-5051268 Fax:+886-6-5053381 <http://www.gtop-tech.com/> email: sales@gtop-tech.com
Copyright© 2009 GlobalTop Tech Inc. All right reserved.



FGPMMOSL3 Datasheet

A12

***All the information in this sheet can be used only for Pb- free certification.**

SMT Reflow Soldering Temperature Profile:

(Reference Only)

Average ramp-up rate (25 ~ 150°C): 3°C /sec. max.

Average ramp-up rate (270°C to peak): 3°C /sec. max.

Preheat: 175 ± 25°C, 60 ~ 120 seconds

Temperature maintained above 217°C: 60~150 seconds

Peak temperature: 250 +0/-5°C, 20~40 seconds

Ramp-down rate: 6°C /sec. max.

Time 25°C to peak temperature: 8 minutes max.

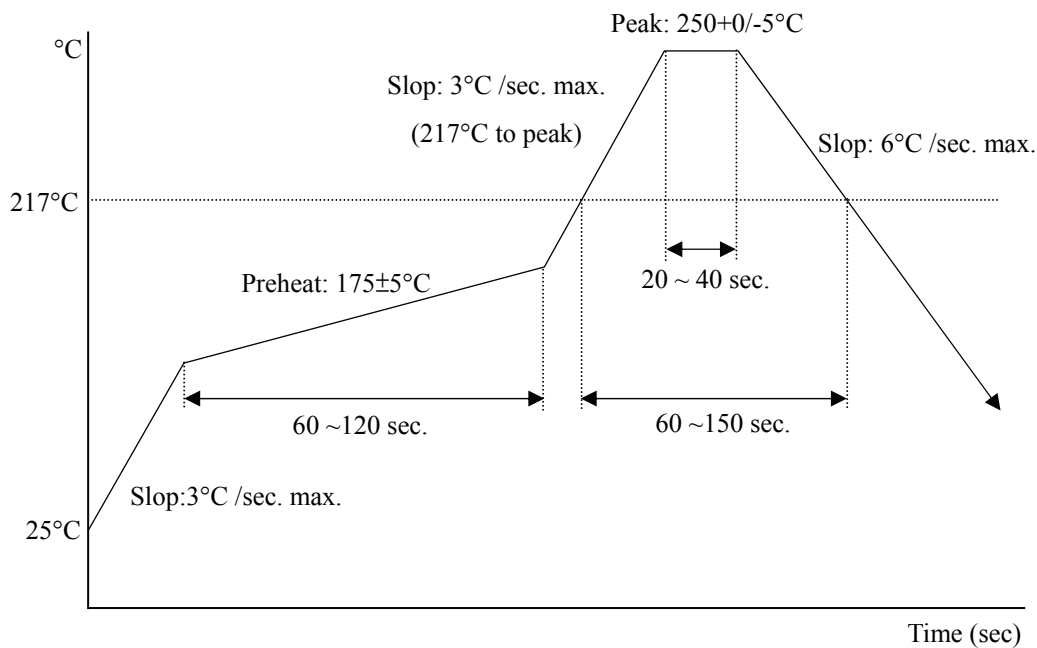

The document is the exclusive property of GlobalTop Tech Inc. and should not be distributed, reproduced, or any other format without prior permission of GlobalTop Tech Inc. Specifications subject to change without prior notice

GlobalTop Tech Inc.

No.16 Nan-ke 9th Rd, Science-Based Industrial Park, Tainan, 741, Taiwan, R.O.C.

Tel:+886-6-5051268 Fax:+886-6-5053381 <http://www.gtop-tech.com/> email: sales@gtop-tech.com

Copyright© 2009 GlobalTop Tech Inc. All right reserved.



FGPMMOSL3 Datasheet

A12

Notes:

1. Module must be pre-baked **before** going through SMT solder reflow process.
2. The usage of solder paste should follow “first in first out” principle. Opened solder paste needs to be monitored and recorded in a timely fashion (can refer to IPQC for related documentation and examples).
3. Temperature and humidity must be controlled in SMT production line and storage area. Temperature of 23°C, 60±5% RH humidity is recommended. (please refer to IPQC for related documentation and examples)
4. When performing solder paste printing, please notice if the amount of solder paste is in excess or insufficient, as both conditions may lead to defects such as electrical shortage, empty solder and etc.
5. The reflow temperature and its profile data must be measured before the SMT process and match the levels and guidelines set by IPQC.

The document is the exclusive property of GlobalTop Tech Inc. and should not be distributed, reproduced, or any other format without prior permission of GlobalTop Tech Inc. Specifications subject to change without prior notice

GlobalTop Tech Inc.

No.16 Nan-ke 9th Rd, Science-Based Industrial Park, Tainan, 741, Taiwan, R.O.C.
Tel:+886-6-5051268 Fax:+886-6-5053381 <http://www.gtop-tech.com/> email: sales@gtop-tech.com
Copyright© 2009 GlobalTop Tech Inc. All right reserved.



FGPMMOSL3 Datasheet

A12

Manual Soldering:

Soldering iron:

Bit Temperature: Under 380°C

Time: Under 3 sec.

Notes:

1. Please do not directly touch the soldering pads on the surface of the PCB board, in order to prevent further oxidation
2. The solder paste must be defrosted to room temperature before use so it can return to its optimal working temperature. The time required for this procedure is unique and dependent on the properties of the solder paste used.
3. The steel plate must be properly assessed before and after use, so its measurement stays strictly within the specification set by SOP.
4. Please watch out for the spacing between soldering joint, as excess solder may cause electrical shortage
5. Please exercise with caution and do not use extensive amount of flux due to possible siphon effects on neighboring components, which may lead to electrical shortage.
6. Please do not use the heat gun for long periods of time when removing the shielding or inner components of the GPS module, as it is very likely to cause a shift to the inner components and will leads to electrical shortage.

The document is the exclusive property of GlobalTop Tech Inc. and should not be distributed, reproduced, or any other format without prior permission of GlobalTop Tech Inc. Specifications subject to change without prior notice

GlobalTop Tech Inc.

No.16 Nan-ke 9th Rd, Science-Based Industrial Park, Tainan, 741, Taiwan, R.O.C.

Tel:+886-6-5051268 Fax:+886-6-5053381 <http://www.gtop-tech.com/> email: sales@gtop-tech.com

Copyright© 2009 GlobalTop Tech Inc. All right reserved.