

# ASMT-Jx33

## 3W Mini Power LED Light Source



### Data Sheet



Lead (Pb) Free  
RoHS 6 fully  
compliant



#### Description

The 3W Mini Power LED Light Source is a high performance energy efficient device which delivers high flux output and possesses high color rendering index. This device can handle high driving current. Option with electrically isolated metal slug is also available.

The White Mini Power LED is available in the range of color temperature from 2700K to 10000K.

The low profile package design and ultra small footprint is suitable for a wide variety of applications especially where space and height is a constraint.

The package is compatible with reflow soldering process. To facilitate easy pick & place assembly, the LEDs are packed in EIA-compliant tape and reel.

#### Features

- High Color Rendering Index (CRI)
- Available in Cool White, Neutral White and Warm White
- Small footprint and low profile
- Symmetrical outline
- Energy efficient
- Direct heat transfer from metal slug to mother board
- Compatible with reflow soldering process
- High current operation
- Long operation life
- Wide viewing angle
- Silicone encapsulation
- Non-ESD sensitive (threshold > 16kV)
- MSL 1 products

#### Applications

- Retail lighting
- Display case lighting
- Security lighting
- Commercial lighting such as window decorative lighting in shopping malls
- Architectural lighting

**CAUTION:** Customer is advised to keep the LEDs in the MBB when not in use as prolonged exposure to environment might cause the silver plated leads to tarnish, which might cause difficulties in soldering.

## Package Dimensions

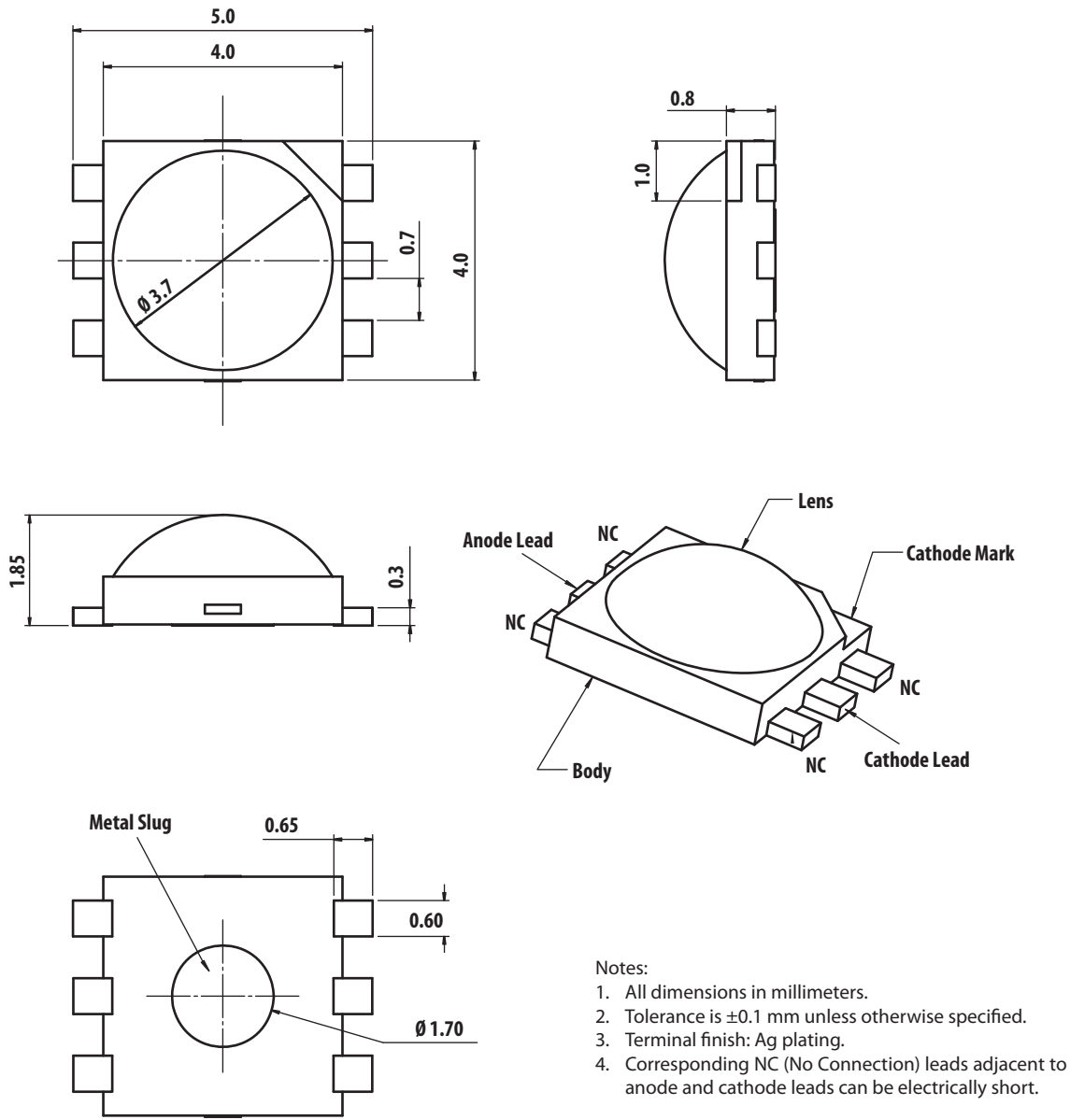
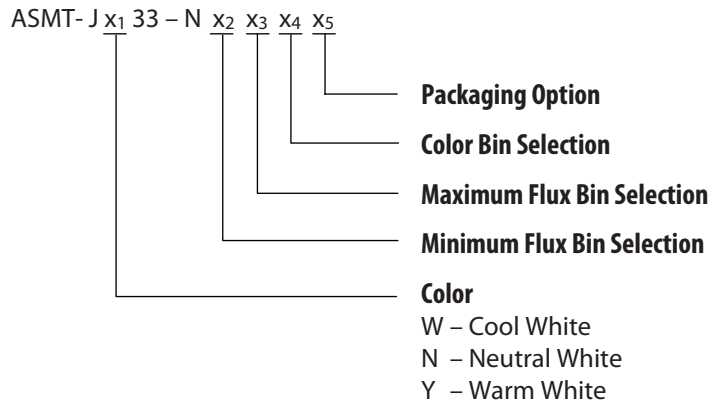

Figure 1. ASMT-Jx33 package outline drawing

## Part Numbering System



Note:

1. Please refer to Page 7 for selection details.

## Device Selection Guide (T<sub>J</sub> = 25°C)

Part Number	Color	Luminous Flux (lm), $\Phi_V^{[1,2]}$			Test Current (mA)	Dice Technology	Electrically Isolated Metal Slug
		Min.	Typ.	Max.			
ASMT-JW33-NSU01	Cool White	51.7	70.0	99.6	350	InGaN	Yes
ASMT-JN33-NSU01	Neutral White	51.7	70.0	99.6	350	InGaN	Yes
ASMT-JY33-NQS01	Warm White	30.6	45.0	67.2	350	InGaN	Yes
ASMT-JY33-NSTJ1	Warm White	51.7	60.0	87.4	350	InGaN	Yes

Notes:

1.  $\Phi_V$  is the total luminous flux output as measured with an integrating sphere at 25ms mono pulse condition.
2. Flux tolerance is  $\pm 10\%$

## Absolute Maximum Ratings

Parameter	InGaN	Units
DC Forward Current <sup>[1]</sup>	700	mA
Power Dissipation	3010	mW
LED Junction Temperature	135	°C
Operating Metal Slug Temperature Range at 350 mA	-40 to +120	°C
Operating Metal Slug Temperature Range at 700 mA	-40 to +105	°C
Storage Temperature Range	-40 to + 120	°C
Soldering Temperature	Refer to Figure. 12	
Reverse Voltage <sup>[2]</sup>	Not recommended	

Notes:

1. Derate linearly based on Figure 8.
2. Not designed for reverse bias operation.

### Optical Characteristics at 350 mA (T<sub>J</sub> = 25°C)

Part Number	Color	Correlated Color Temperature, CCT (Kelvin)		Viewing Angle, 2θ <sub>½</sub> <sup>[1]</sup> (°)	Luminous Efficiency (lm/W)	Color Rendering Index, CRI
		Min.	Max.	Typ.	Typ.	Typ.
ASMT-JW33-NSU01	Cool White	4500	10000	140	63	80
ASMT-JN33-NSU01	Neutral White	3500	4500	140	63	80
ASMT-JY33-NQS01	Warm White	2700	3500	140	40	90
ASMT-JY33-NSTJ1		2850	3250	140	54	85

Note:

1. θ<sub>½</sub> is the off-axis angle where the luminous intensity is ½ the peak intensity.

### Electrical Characteristic at 350 mA (T<sub>J</sub> = 25°C)

Dice Type	Forward Voltage, V <sub>F</sub> (Volts)			Thermal Resistance, R <sub>θJ-MS</sub> (°C/W) <sup>[1]</sup>
	Min.	Typ.	Max.	Typ.
InGaN	2.8	3.2	3.5	9

Note:

1. R<sub>θJ-MS</sub> is Thermal Resistance from LED junction to metal slug.

### Optical and Electrical Characteristic at 700 mA (T<sub>J</sub> = 25°C)

Part Number	Color	Luminous Flux (lm), Φ <sub>v</sub>	Forward Voltage, V <sub>F</sub> (Volts)
		Typ.	Typ.
ASMT-JW33-NSU01	Cool White	125.0	3.6
ASMT-JN33-NSU01	Neutral White	125.0	3.6
ASMT-JY33-NQS01	Warm White	80.0	3.6
ASMT-JY33-NSTJ1		107.0	3.6

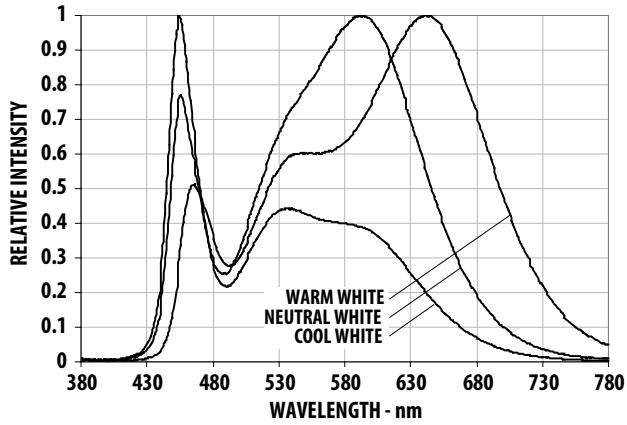

Figure 2. Relative Intensity vs. Wavelength for Cool White and Warm White

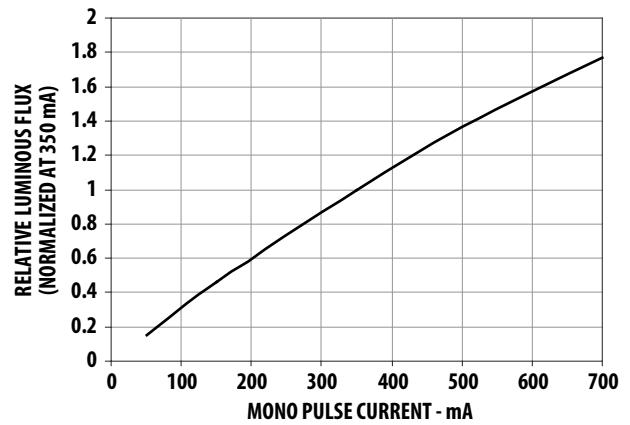

Figure 3. Relative Luminous Flux vs. Mono Pulse Current

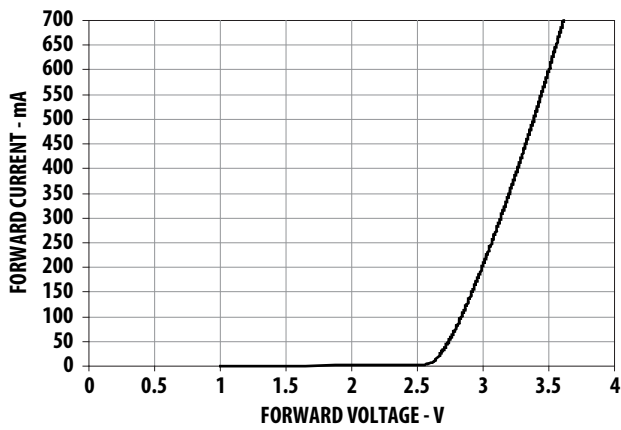

Figure 4. Forward Current vs. Forward Voltage

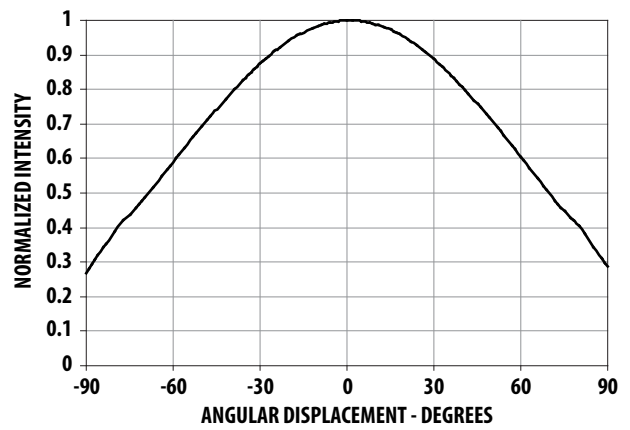

Figure 5. Radiation Pattern for Cool White, Warm White and Neutral White

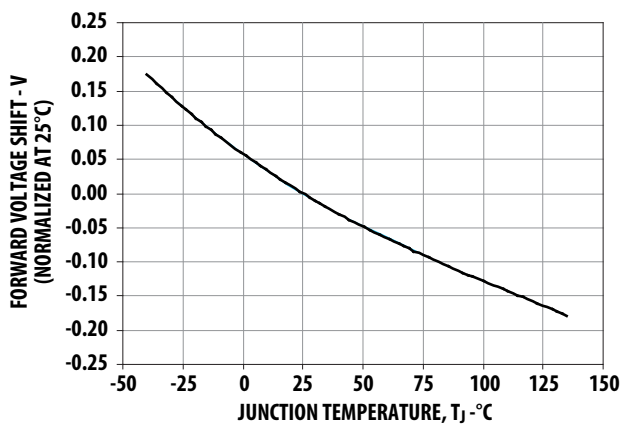

Figure 6. Relative Light Output vs. Junction Temperature

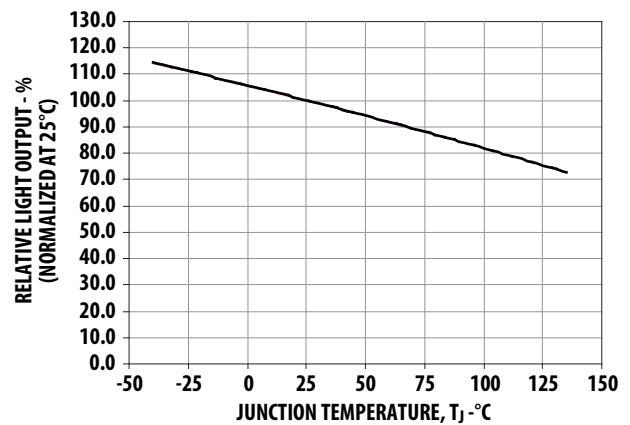

Figure 7. Forward Voltage Shift vs. Junction Temperature

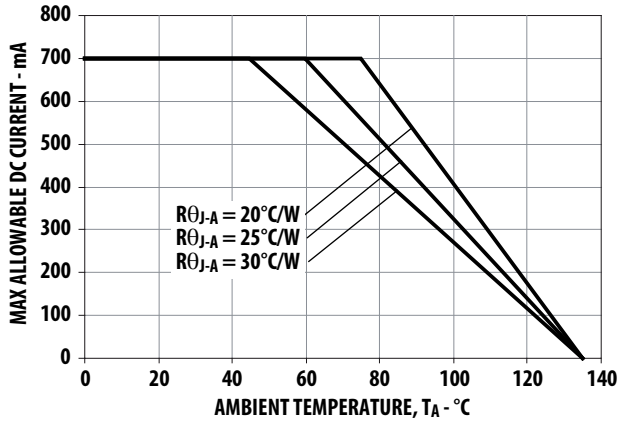

Figure 8. Maximum Forward Current vs. Ambient Temperature. Derated based on  $T_{JMAX} = 125^{\circ}\text{C}$ ,  $R_{\theta J-A} = 20^{\circ}\text{C/W}$ ,  $25^{\circ}\text{C/W}$  and  $30^{\circ}\text{C/W}$

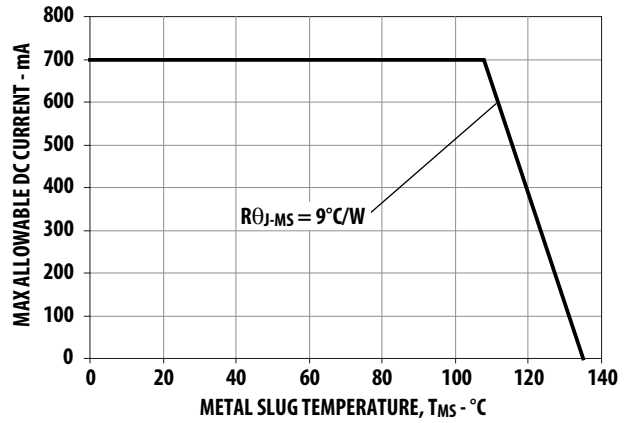

Figure 9. Maximum Forward Current vs. Metal Slug Temperature. Derated based on  $T_{JMAX} = 125^{\circ}\text{C}$ ,  $R_{\theta J-MS} = 9^{\circ}\text{C/W}$

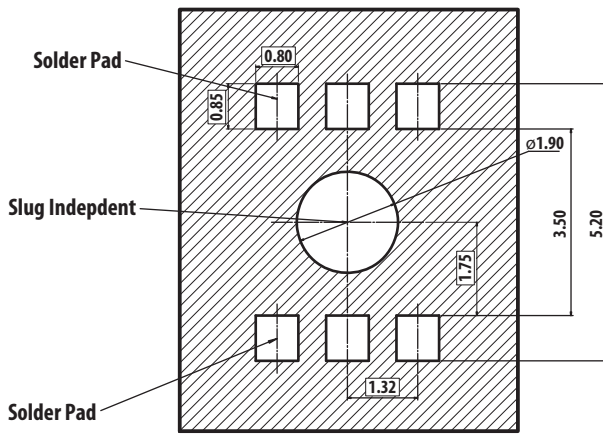

Figure 10. Recommended soldering land pattern

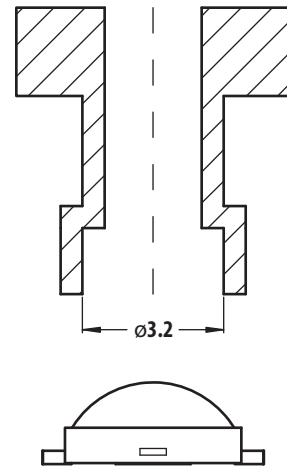

Figure 11. Recommended pick and place nozzle tip. Inner diameter = 3.2 mm

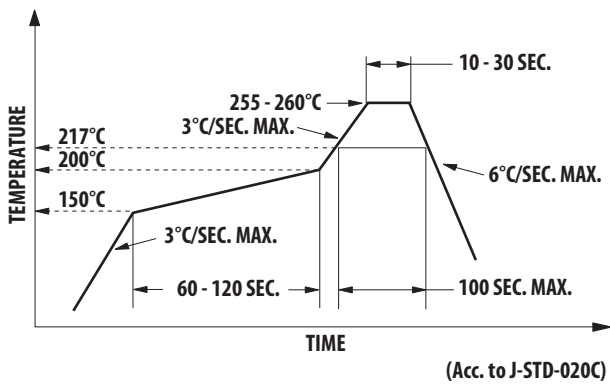

Figure 12. Recommended Reflow Soldering Profile

Note:

For detail information on reflow soldering of Avago surface mount LEDs, do refer to Avago Application Note AN1060 Surface Mounting SMT LED Indicator Components.

## Option Selection Details

### ASMT-J x<sub>1</sub> 33 – N x<sub>2</sub> x<sub>3</sub> x<sub>4</sub> x<sub>5</sub>

x<sub>2</sub> – Minimum Flux Bin Selection

x<sub>3</sub> – Maximum Flux Bin Selection

x<sub>4</sub> – Color Bin Selection

x<sub>5</sub> – Packaging Option

## Flux Bin Limit [x<sub>2</sub>, x<sub>3</sub>]

Bin ID	Luminous Flux (lm) at 350 mA	
	Min.	Max.
Q	30.6	39.8
R	39.8	51.7
S	51.7	67.2
T	67.2	87.4
U	87.4	99.6

Tolerance for each bin limits is ±10%

## Color Bin Selection [x<sub>4</sub>]

Individual reel will contain parts from one color bin selection only.

### Cool White

Selection	Bin ID
0	Full Distribution
H	UN, VN, U0 and V0
J	WN, VN, W0 and V0
K	XN, WN, X0 and W0
P	Y0

### Warm White

Selection	Bin ID
0	Full Distribution
H	M1, N1, M0 and N0
J	P1, N1, P0 and N0
K	Q1, P1, Q0 and P0

### Neutral White

Selection	Bin ID
0	Full Distribution
G	S1, R1, S0 and R0
H	TN, S1, T0 and S0

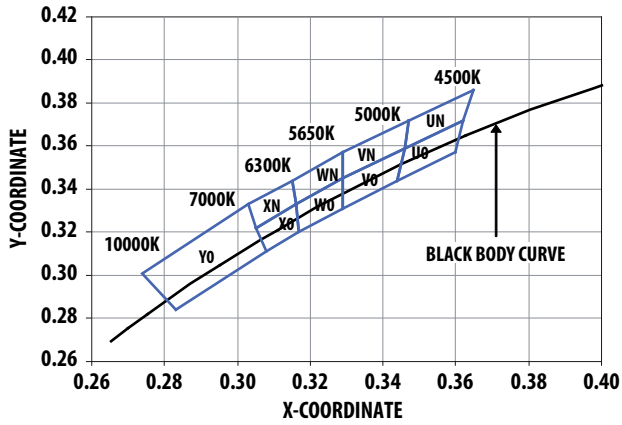

Figure 13. Color bin Structure for Cool White

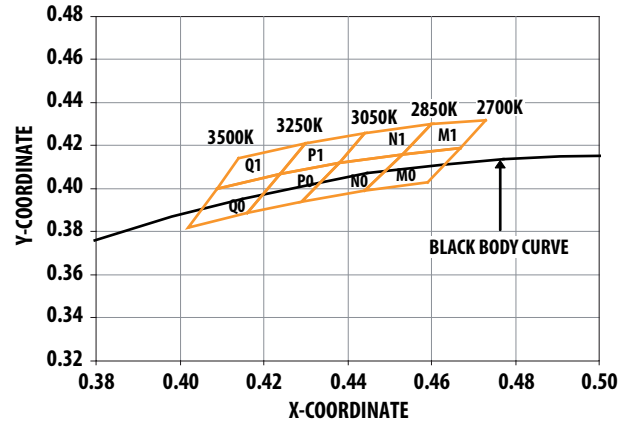

Figure 14. Color bin structure for Warm White

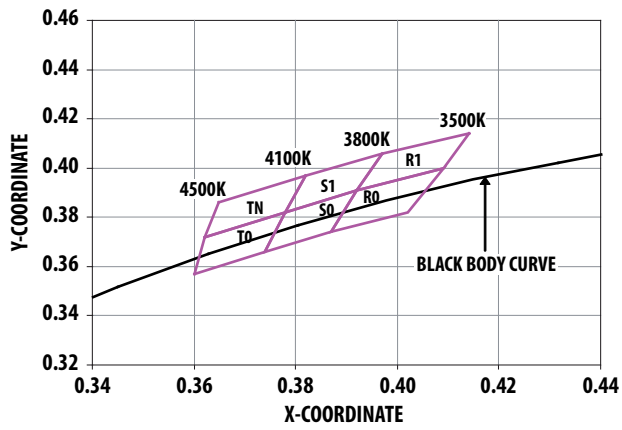

Figure 15. Color bin structure for Neutral White



## Color Bin Limits

Cool White	Color Limits (Chromaticity Coordinates)				
Bin UN	x	0.365	0.362	0.346	0.347
	y	0.386	0.372	0.359	0.372
Bin UO	x	0.362	0.360	0.344	0.346
	y	0.372	0.357	0.344	0.359
Bin VN	x	0.329	0.329	0.347	0.346
	y	0.345	0.357	0.372	0.359
Bin VO	x	0.329	0.329	0.346	0.344
	y	0.331	0.345	0.359	0.344
Bin WN	x	0.329	0.316	0.315	0.329
	y	0.345	0.333	0.344	0.357
Bin W0	x	0.329	0.329	0.317	0.316
	y	0.345	0.331	0.320	0.333
Bin XN	x	0.305	0.303	0.315	0.316
	y	0.322	0.333	0.344	0.333
Bin XO	x	0.308	0.305	0.316	0.317
	y	0.311	0.322	0.333	0.320
Bin YO	x	0.308	0.283	0.274	0.303
	y	0.311	0.284	0.301	0.333

Tolerance: ±0.01

Neutral White	Color Limits (Chromaticity Coordinates)				
Bin R1	x	0.414	0.409	0.392	0.397
	y	0.414	0.400	0.391	0.406
Bin RO	x	0.392	0.387	0.402	0.409
	y	0.391	0.374	0.382	0.400
Bin S1	x	0.397	0.392	0.378	0.382
	y	0.406	0.391	0.382	0.397
Bin S0	x	0.392	0.387	0.374	0.378
	y	0.391	0.374	0.366	0.382
Bin TN	x	0.382	0.378	0.362	0.365
	y	0.397	0.382	0.372	0.386
Bin T0	x	0.378	0.374	0.360	0.362
	y	0.382	0.366	0.357	0.372

Tolerance: ±0.01

Warm White	Color Limits (Chromaticity Coordinates)				
Bin M1	x	0.460	0.453	0.467	0.473
	y	0.430	0.416	0.419	0.432
Bin M0	x	0.453	0.444	0.459	0.467
	y	0.416	0.399	0.403	0.419
Bin N1	x	0.444	0.438	0.453	0.460
	y	0.426	0.412	0.416	0.430
Bin N0	x	0.438	0.429	0.444	0.453
	y	0.412	0.394	0.399	0.416
Bin P1	x	0.430	0.424	0.438	0.444
	y	0.421	0.407	0.412	0.426
Bin P0	x	0.424	0.416	0.429	0.438
	y	0.407	0.389	0.394	0.412
Bin Q1	x	0.414	0.409	0.424	0.430
	y	0.414	0.400	0.407	0.421
Bin Q0	x	0.409	0.402	0.416	0.424
	y	0.400	0.382	0.389	0.407

Tolerance: ±0.01

## Packaging Option [x<sub>5</sub>]

Selection	Option
1	Tape and Reel

## Example

### ASMT-JW33-NSU01

ASMT-JW33-Nxxxx – Cool White, InGaN,  
Electrically isolated Heat Sink

- X<sub>2</sub> = S – Minimum Flux Bin S
- X<sub>3</sub> = U – Maximum Flux Bin U
- X<sub>4</sub> = 0 – Full Distribution
- X<sub>5</sub> = 1 – Tape and Reel Option

## Tape and Reel – Option 1

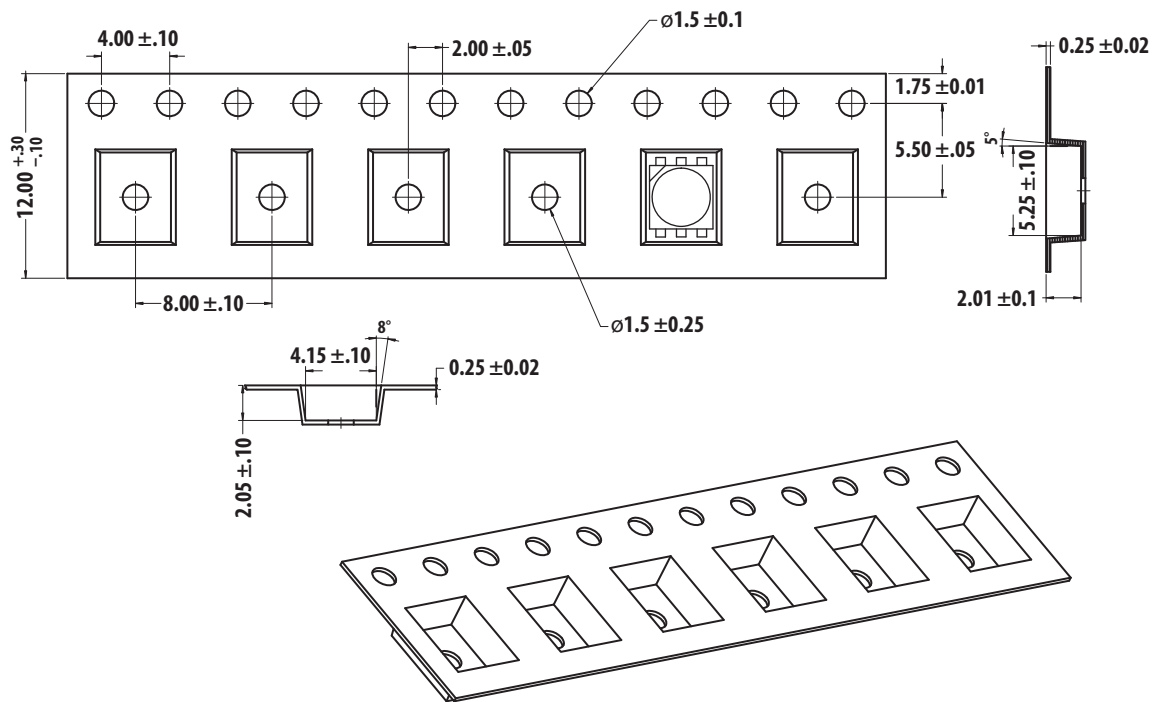
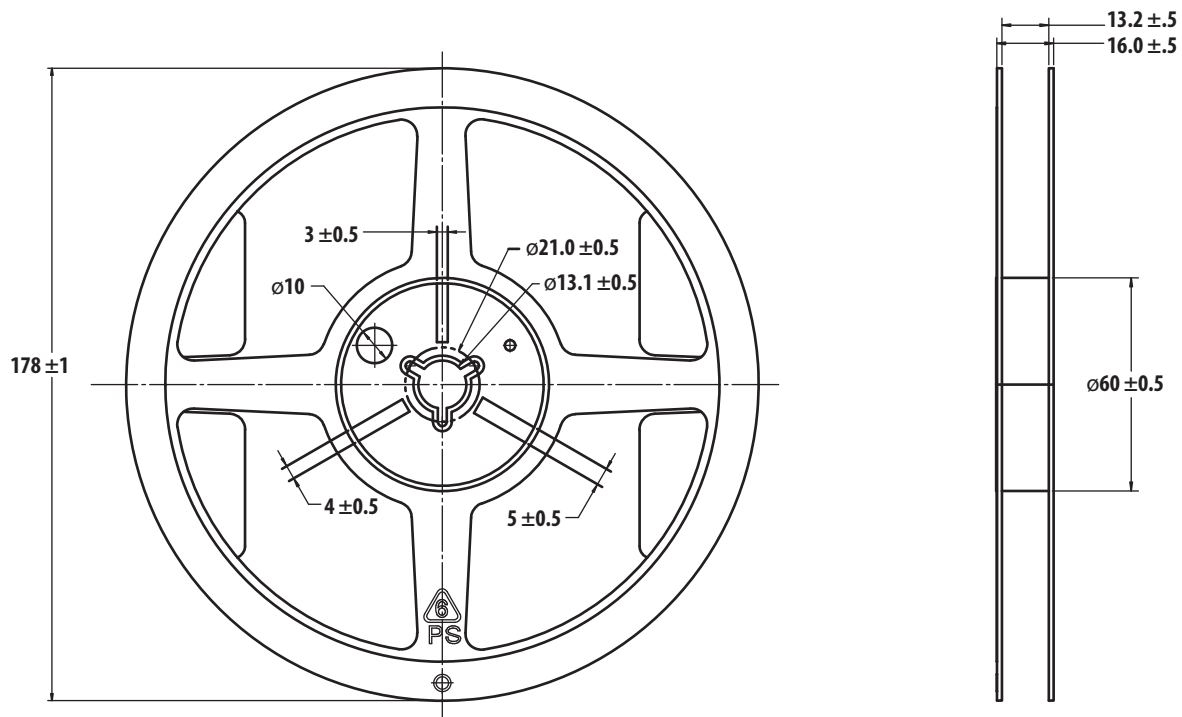

Figure 16. Carrier Tape Dimensions



### Notes:

1. Empty component pockets sealed with top cover tape.
2. 250 or 500 pieces per reel.
3. Drawing not to scale.
4. All dimensions are in millimeters.

Figure 17. Reel dimensions

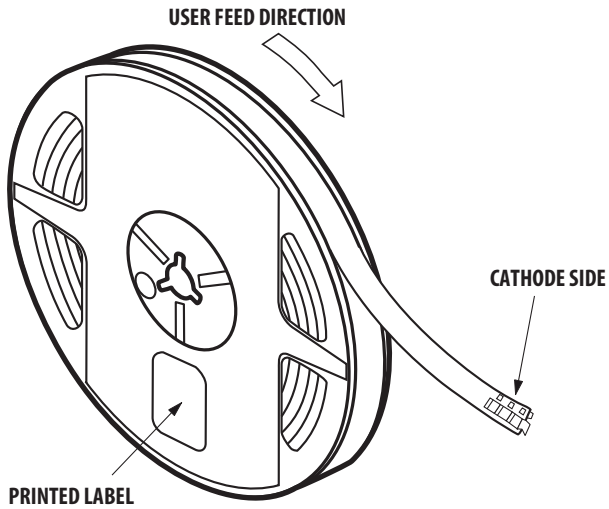

Figure 18. Reeling Orientation

**DISCLAIMER:** Avago's products and software are not specifically designed, manufactured or authorized for sale as parts, components or assemblies for the planning, construction, maintenance or direct operation of a nuclear facility or for use in medical devices or applications. Customer is solely responsible, and waives all rights to make claims against avago or its suppliers, for all loss, damage, expense or liability in connection with such use.

For product information and a complete list of distributors, please go to our web site: [www.avagotech.com](http://www.avagotech.com)

Avago, Avago Technologies, and the A logo are trademarks of Avago Technologies in the United States and other countries. Data subject to change. Copyright © 2005-2010 Avago Technologies. All rights reserved.  
AV02-2430EN - July 20, 2010

**AVAGO**  
TECHNOLOGIES