

Features

- Input Voltage Range: 36V to 75V
- 20W Rated
- 82% Efficiency
- 1500 VDC Isolation
- Low Profile (8.5 mm)
- Small Footprint: 1.52in x 1.73in
- Remote On/Off
- Short Circuit Protection
- Over Temperature Shutdown
- Under-Voltage Lockout
- UL1950 Recognized
- CSA 22.2 950 Certified
- EN60950 Approved
- 4x10⁶ Hrs MTBF

Description

The PT4120 power modules are a series of isolated DC/DC converters housed a low-profile package. Rated for 20 watts or 5A, the series includes standard output voltages ranging from as low as 1.5VDC to 15VDC. The output may be adjusted $\pm 10\%$ of nominal. These converters are ideal for Telecom, Industrial, Computer, and other distributed power applications that require input-to-output isolation.

Using multiple PT4120 modules, system designers can implement a complete custom power supply solution. The flexibility of full isolation also allows the input or output to be configured for negative voltage operation.

The PT4120 series requires no additional components for proper operation.

Ordering Information

PT4121 □	=	3.3V/5A	(16.5W)
PT4122 □	=	5.0V/4A	
PT4123 □	=	12.0V/1.6A	
PT4124 □	=	15.0V/1.3A	
PT4125 □	=	5.2V/3.8A	
PT4126 □	=	1.5V/5A	(7.5W)
PT4127 □	=	1.8V/5A	(9W)
PT4128 □	=	2.5V/5A	(12.5W)
PT4129 □	=	1.65V/5A	(8.25W)

Pin-Out Information

Pin	Function
1	Remote On/Off †
2	-V _{IN}
3	+V _{IN}
4	-V _{OUT}
5	+V _{OUT}
6	V _{OUT} Adjust †

† For further information, see application notes.

PT Series Suffix (PT1234x)

Case/Pin Configuration	Order Suffix	Package Code *
Horizontal	A	(EGD)
SMD	C	(EGE)

* Previously known as package style 710.

(Reference the applicable package code drawing for the dimensions and PC board layout)

Standard Application

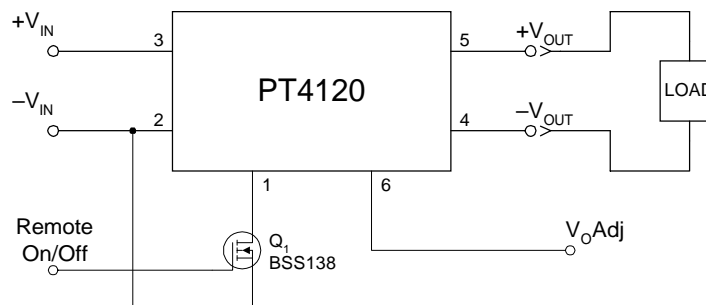

PT4120 Series

20-W 48-V Input Isolated DC/DC Converter

Specifications (Unless otherwise stated, $T_a = 25^\circ\text{C}$, $V_{in} = 48\text{V}$, $C_{out} = 0\mu\text{F}$, and $I_o = I_{o,max}$)

Characteristic	Symbol	Conditions	PT4120 SERIES			Units	
			Min	Typ	Max		
Output Current	I_o	Over V_{in} range	$V_o = 15\text{V}$	0.1 ⁽¹⁾	—	1.3	A
			$V_o = 12\text{V}$	0.1 ⁽¹⁾	—	1.6	
			$V_o = 5.0\text{V}$	0.1 ⁽¹⁾	—	4.0	
			$V_o \leq 3.3\text{V}$	0.1 ⁽¹⁾	—	5.0	
Input Voltage Range	V_{in}	Over I_o Range	36.0	48.0	75.0	VDC	
Set Point Voltage Tolerance	$V_o\text{tol}$		$V_o \geq 5.0\text{V}$	—	± 1	± 1.5	$\%V_o$
			$V_o \leq 3.3\text{V}$	—	—	± 50	mV
Temperature Variation	Reg_{temp}	$-40^\circ \leq T_a \leq +85^\circ\text{C}$	—	± 0.5	—	$\%V_o$	
Line Regulation	Reg_{line}	Over V_{in} range	$V_o \geq 5.0\text{V}$	—	± 0.2	± 1.0	$\%V_o$
			$V_o \leq 3.3\text{V}$	—	± 7	± 33	mV
Load Regulation	Reg_{load}	Over I_o range	$V_o \geq 5.0\text{V}$	—	± 0.4	± 1.0	$\%V_o$
			$V_o \leq 3.3\text{V}$	—	± 13	± 33	mV
Total Output Voltage Variation	$\Delta V_{o,tot}$	Includes set-point, line load, $-40^\circ \leq T_a \leq +85^\circ\text{C}$	$V_o \geq 5.0\text{V}$	—	± 2	—	$\%V_o$
			$V_o \leq 3.3\text{V}$	—	± 67	—	mV
Efficiency	η		$V_o = 15\text{V}$	—	86	—	%
			$V_o = 12\text{V}$	—	83	—	
			$V_o = 5.0\text{V}$	—	82	—	
			$V_o = 3.3\text{V}$	—	78	—	
			$V_o = 1.8\text{V}$	—	67	—	
V_o Ripple (pk-pk)	V_r	20MHz bandwidth	$V_o \geq 5.0\text{V}$	—	0.5	—	$\%V_o$
			$V_o \leq 3.3\text{V}$	—	15	—	mV _{pp}
Transient Response	t_{tr}	0.1A/ μs , load step 50% to 100% $I_{o,max}$	—	100	—	μs	
	ΔV_{tr}	V_o over/undershoot	$V_o \geq 5.0\text{V}$	—	± 3.0	—	$\%V_o$
			$V_o \leq 3.3\text{V}$	—	± 150	—	mV
Short Circuit Current	I_{sc}		—	$2 \times I_{o,max}$	—	A	
Switching Frequency	f_s	Over V_{in} range	$V_o \geq 12.0\text{V}$	600	650	700	kHz
			$V_o \leq 5.2\text{V}$	800	850	900	
Under-Voltage Lockout	UVLO		—	31	—	V	
Remote On/Off (Pin 1)		Referenced to $-V_{in}$ (pin 2)					
Input High Voltage	V_{IH}		2.5	—	7.0 ⁽²⁾	V	
Input Low Voltage	V_{IL}		-0.2	—	+0.8		
Input Low Current	I_{IL}		—	-10	—	μA	
Standby Input Current	$I_{in, standby}$	pins 1 & 2 connected	—	7	50	mA	
Internal Input Capacitance	C_{in}		—	0.5	—	μF	
External Output Capacitance	C_{out}	Between $+V_o$ and $-V_o$	0	—	200	μF	
Isolation Voltage		Input to output	1500	—	—	V	
			—	1100	—	pF	
Capacitance			10	—	—	M Ω	
Resistance							
Operating Temperature Range	T_a	Over V_{in} range	-40	—	+85 ⁽³⁾	$^\circ\text{C}$	
Storage Temperature	T_s	—	-40	—	+125	$^\circ\text{C}$	
Reliability	MTBF	Per Bellcore TR-332 50% stress, $T_a = 40^\circ\text{C}$, ground benign	4.0	—	—	10^6 Hrs	
Mechanical Shock	—	Per Mil-Std-883D, method 2002.3, 1mS, half-sine, mounted to a fixture	—	500	—	G's	
Mechanical Vibration	—	Per Mil-Std-883D, method 2007.2, 20-2000Hz, soldered in a PC board	—	15	—	G's	
Weight	—	—	—	23	—	grams	
Flammability	—	Materials meet UL 94V-0	—	—	—		

Notes: (1) The DC/DC converter will operate at no load with reduced specifications.

(2) The Remote On/Off (pin 1) has an internal pull-up, and if it is left open circuit the PT4120 will operate when input power is applied. Refer to the application notes for interface considerations.

(3) See Safe Operating Area curves or contact the factory for the appropriate derating.

20-W 48-V Input Isolated DC/DC Converter

PT4121, 3.3 VDC (See Note A)

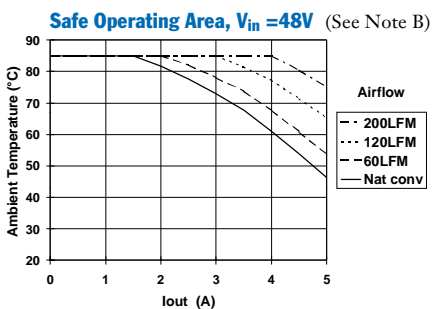
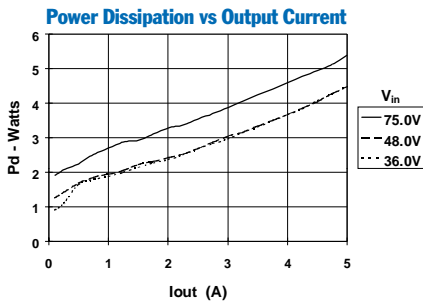
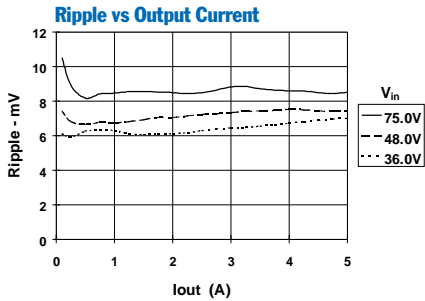
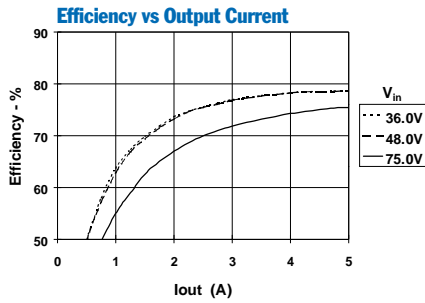

PT4122, 5.0 VDC (See Note A)

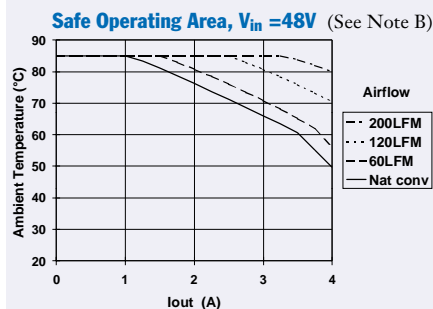
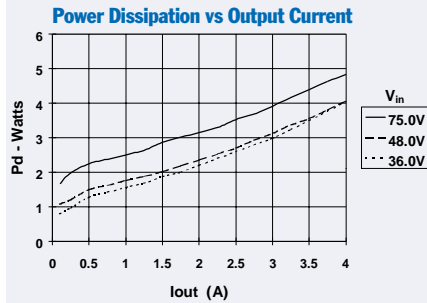
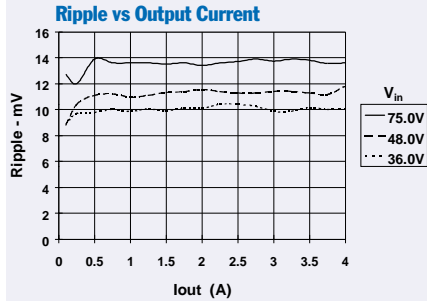
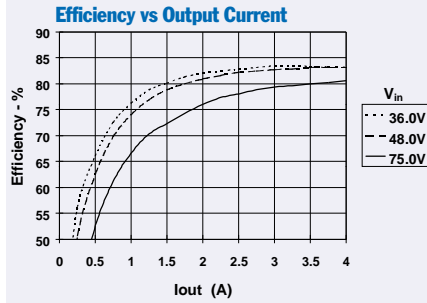

PT4123, 12.0 VDC (See Note A)

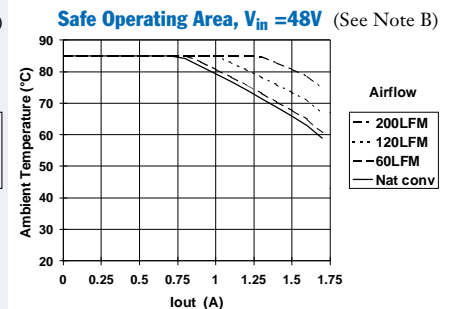
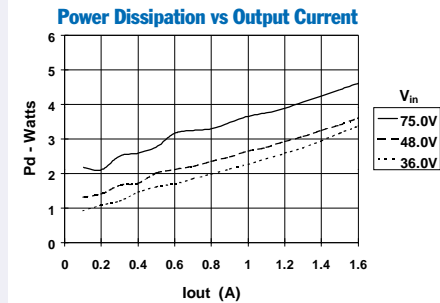
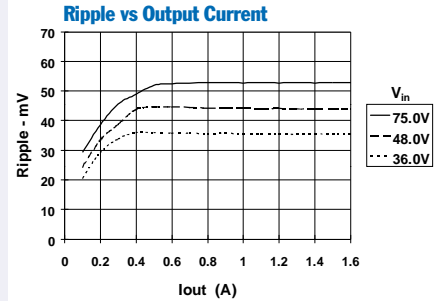
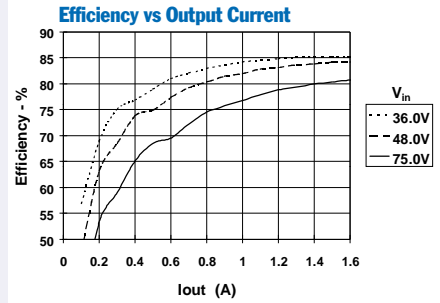

Note A: Characteristic data has been developed from actual products tested at 25°C. This data is considered typical data for the Converter.
Note B: SOA curves represent the conditions at which internal components are at or below the manufacturer's maximum operating temperatures

Using the Remote On/Off Function on the PT4120/PT4140 Series of Isolated DC/DC Converters

For applications requiring output voltage on/off control, the PT4120/4140 series of DC/DC converters incorporate a remote on/off function. This function may be used in applications that require battery conservation, power-up/shutdown sequencing, and/or to co-ordinate the power-up of the regulator for active in-rush current control. (See the related application note, AN21).

This function is provided by the *Remote On/Off* control, pin1. If pin 1 is left open-circuit, the converter provides a regulated output whenever a valid source voltage³ is applied between +V_{in}(pin 3), and -V_{in} (pin 2). Applying a low-level ground signal¹ to pin 1 will disable the regulator output⁵.

Table 1 provides details of the threshold requirements for the *Remote On/Off* pin. Figure 1 shows how a discrete MOSFET (Q₁)⁴, may be referenced to the negative input voltage rail and used with this control input.

Table 1 Inhibit Control Thresholds

Parameter	min	max
Enable (V _{IH})	2.5V	(Open Circuit) ^{2,4}
Disable (V _{IL})	-0.3V	0.8V

Notes:

1. The on/off control uses -V_{in} (pin 2), the primary side of the converter as its ground reference. All voltages specified are with respect to -V_{in}.
2. The on/off control internal circuitry is a high impedance 10µA current source. The open-circuit voltage may be as high as 8.3Vdc.
3. The PT4120/40 series incorporates an “Under Voltage Lockout” (UVLO) function. This function automatically inhibits the converter output until there is sufficient input voltage for the converter to produce a regulated output. Table 2 gives the applicable UVLO thresholds.

Table 2 UVLO Thresholds

Series	UVLO Threshold	V _m Range
PT4120	31V Typical	36 – 75V
PT4140	15V Typical	18 – 40V

4. The *Remote On/Off* input of the PT4120/40 series regulators must be controlled with an open-collector (or open-drain) discrete transistor or MOSFET. *Do not* use a pull-up resistor.
5. When the converter output is disabled, the current drawn from the input supply is typically reduced to 8mA (16mA maximum).

6. Keep the on/off transition to less than 1ms. This prevents erratic operation of the ISR, whereby the output voltage may drift un-regulated between 0V and the rated output during power-up.

Figure 1

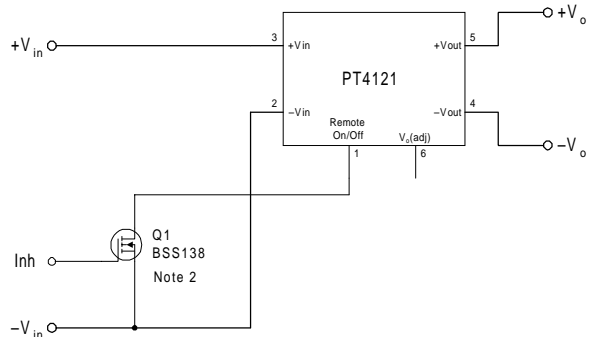

Turn-On Time: The converter typically produces a fully regulated output voltage within 50ms after the application of power, or the removal of the low voltage signal⁶ from the *Remote On/Off* pin. The actual turn-on time will vary with the input voltage, output load, and the total amount of capacitance connected to the output. Using the circuit of Figure 1, Figure 2 shows the output voltage and input current waveforms of a PT4121 after Q₁ is turned off. The turn off of Q₁ corresponds to the drop in Q₁ V_{gs} voltage. The waveforms were measured with a 48Vdc input voltage, and 2.75-A resistive load.

Figure 2

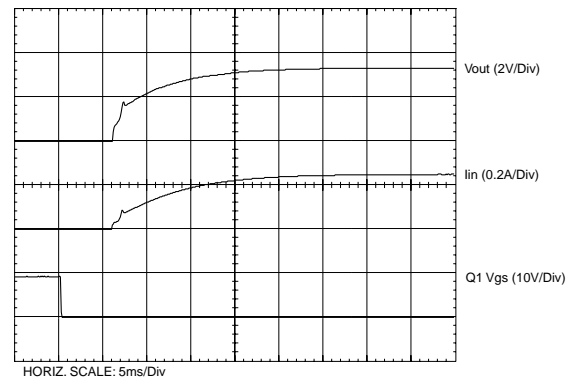

Adjusting the Output Voltage of the PT4120/PT4140 Series of Isolated DC/DC Converters

The factory pre-set output voltage of Power Trends' PT4120 and PT4140 series of isolated DC/DC converters may be adjusted within $\pm 10\%$ of nominal. Adjustment is made from the secondary side of the regulator¹ with a single external resistor. For the input voltage range specified in the data sheet Table 1 gives the allowable adjustment range for each model, as V_o (min) and V_o (max).

Adjust Up: An increase in the output voltage is obtained by adding a resistor, R_2 between pin 6 (V_o adjust), and pin 4 ($-V_{out}$).

Adjust Down: Add a resistor (R_1), between pin 6 (V_o adjust) and pin 5 ($+V_{out}$).

Refer to Figure 1 and Table 2 for both the placement and value of the required resistor, (R_1) or R_2 .

Notes:

1. The PT4120 and PT4140 series of DC/DC converters incorporate isolation between the V_{in} and V_o terminals. Adjustment of the output voltage is made to the regulation circuit on the secondary or output side of the converter.
2. The maximum rated output power for this series is 20W. An increase in the output voltage may therefore require a corresponding reduction in the maximum output current (see Table 1). The revised maximum output current must be determined as follows:-

$$I_o(\max) = \frac{20}{V_a} \text{ A, or } 5\text{A, whichever is less.}$$

Where V_a is the adjusted output voltage.

3. Use only a single 1% resistor in either the (R_1) or R_2 location. Place the resistor as close to the ISR as possible.

4. Never connect capacitors to V_o adjust. Any capacitance added to the V_o adjust control pin will affect the stability of the ISR.

The values of (R_1) [adjust down], and R_2 [adjust up], can also be calculated using the following formulas.

$$(R_1) = \frac{K_o (V_a - V_r)}{V_r (V_o - V_a)} - R_s \quad \text{k}\Omega$$

$$R_2 = \frac{K_o}{(V_a - V_o)} - R_s \quad \text{k}\Omega$$

Where V_o = Original output voltage
 V_a = Adjusted output voltage
 V_r = Reference voltage (Table 1)
 K_o = Multiplier constant (Table 1)
 R_s = Internal series resistance (Table 1)

Figure 1

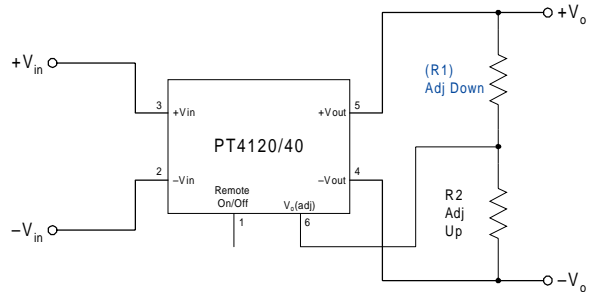

Table 1

DC/DC CONVERTER ADJUSTMENT RANGE AND FORMULA PARAMETERS

Series Pt #	PT4126	PT4129	PT4127	PT4128	PT4121	PT4122	PT4125	PT4123	PT4124
48V Bus	PT4126	PT4129	PT4127	PT4128	PT4121	PT4122	PT4125	PT4123	PT4124
24V Bus	PT4146	PT4147	PT4148	PT4141	PT4142	PT4143	PT4144		
Max Current ²	5A	5A	5A	5A	5A	4A	3.8A	1.6A	1.3A
V_o (nom)	1.5	1.65	1.8	2.5	3.3	5.0	5.2V	12.0	15.0
V_a (min)	1.35	1.49	1.62	2.25	2.95	4.5	4.75	10.8	13.5
V_a (max)	1.65	1.81	1.98	2.75	3.65	5.5	5.75	13.2	16.5
V_r	1.225	1.225	1.225	1.225	1.225	2.5	2.5	2.5	2.5
K_o (V·k Ω)	67.07	63.9	69.7	64.2	69.3	125.2	134.7	139.8	137.6
R_s (k Ω)	43.2	66.5	110.0	187.0	187.0	187.0	243.0	110.0	90.9

Table 2

DC/DC CONVERTER SERIES ADJUSTMENT RESISTOR VALUES

Series Pt #	48V Bus				24V Bus		12.0Vdc		15.0Vdc	
	PT4126	PT4127	PT4128	PT4121	PT4122	PT4142	PT4123	PT4143	PT4124	PT4144
V _o (nom)	1.5Vdc	1.8Vdc	2.5Vdc	3.3Vdc	5.0Vdc		12.0Vdc		15.0Vdc	
V _a (req'd)	V _a (req'd)				V _a (req'd)		V _a (req'd)		V _a (req'd)	
1.35	(2.8)kΩ				4.5	(12.6)kΩ	10.8	(276.0)kΩ		
1.4	(53.2)kΩ				4.55	(40.3)kΩ	11.0	(365.0)kΩ		
1.45	(204.0)kΩ				4.6	(75.0)kΩ	11.2	(497.0)kΩ		
1.5					4.65	(120.0)kΩ	11.4	(719.0)kΩ		
1.55	1.3MΩ				4.7	(179.0)kΩ	11.6	(1.16)MΩ		
1.6	627.0kΩ				4.75	(262.0)kΩ	11.8			
1.65	404.0kΩ	(51.7)kΩ			4.8	(387.0)kΩ	12.0			
1.7		(161.0)kΩ			4.85	(595.0)kΩ	12.2	588.0kΩ		
1.75		(489.0)kΩ			4.9	(1.01)MΩ	12.4	239.0kΩ		
1.8					4.95		12.6	123.0kΩ		
1.85		1.28MΩ			5.0		12.8	64.6kΩ		
1.9		587.0kΩ			5.05		13.0	29.7kΩ		
1.95		355.0kΩ			5.1	1.06MΩ	13.2	6.4kΩ		
2.25			(26.5)kΩ		5.15	645.0kΩ	13.5		(312.0)kΩ	
2.3			(92.9)kΩ		5.2	437.0kΩ	13.6		(345.0)kΩ	
2.35			(203.0)kΩ		5.25	312.0kΩ	13.8		(427.0)kΩ	
2.4			(425.0)kΩ		5.3	229.0kΩ	14.0		(542.0)kΩ	
2.45			(1.09)MΩ		5.35	169.0kΩ	14.2		(713.0)kΩ	
2.5					5.4	125.0kΩ	14.4		(1.0)MΩ	
2.55			1.09MΩ		5.45	90.2kΩ	14.6		(1.57)MΩ	
2.6			450.0kΩ		5.5	62.4kΩ	14.8			
2.65			237.0kΩ				15.0			
2.7			131.0kΩ				15.2		597.0kΩ	
2.75			67.7kΩ				15.4		253.0kΩ	
2.95				(90.7)kΩ			15.6		138.0kΩ	
3.0				(146.0)kΩ			15.8		81.0kΩ	
3.05				(224.0)kΩ			16.0		46.6kΩ	
3.1				(341.0)kΩ			16.5		0.8kΩ	
3.15				(536.0)kΩ						
3.2				(926.0)kΩ						
3.25				(2.09)MΩ						
3.3										
3.35				1.19MΩ						
3.4				502.0kΩ						
3.45				272.0kΩ						
3.5				158.0kΩ						
3.55				88.7kΩ						
3.6				42.7kΩ						
3.65				9.9kΩ						

R₁ = (Blue) R₂ = Black

PACKAGING INFORMATION

Orderable Device	Status ⁽¹⁾	Package Type	Package Drawing	Pins	Package Qty	Eco Plan ⁽²⁾	Lead/Ball Finish	MSL Peak Temp ⁽³⁾
PT4121C	ACTIVE	DIP MOD ULE	EGE	6	16	Pb-Free (RoHS)	Call TI	Level-1-215C-UNLIM
PT4122A	ACTIVE	DIP MOD ULE	EGD	6	16	Pb-Free (RoHS)	Call TI	N / A for Pkg Type
PT4122C	ACTIVE	DIP MOD ULE	EGE	6	16	Pb-Free (RoHS)	Call TI	Level-1-215C-UNLIM
PT4123A	ACTIVE	DIP MOD ULE	EGD	6	16	Pb-Free (RoHS)	Call TI	N / A for Pkg Type
PT4124A	ACTIVE	DIP MOD ULE	EGD	6	16	Pb-Free (RoHS)	Call TI	N / A for Pkg Type
PT4124C	ACTIVE	DIP MOD ULE	EGE	6	16	Pb-Free (RoHS)	Call TI	Level-1-215C-UNLIM
PT4126A	ACTIVE	DIP MOD ULE	EGD	6	16	Pb-Free (RoHS)	Call TI	N / A for Pkg Type

⁽¹⁾ The marketing status values are defined as follows:

ACTIVE: Product device recommended for new designs.

LIFEBUY: TI has announced that the device will be discontinued, and a lifetime-buy period is in effect.

NRND: Not recommended for new designs. Device is in production to support existing customers, but TI does not recommend using this part in a new design.

PREVIEW: Device has been announced but is not in production. Samples may or may not be available.

OBSELETE: TI has discontinued the production of the device.

⁽²⁾ Eco Plan - The planned eco-friendly classification: Pb-Free (RoHS), Pb-Free (RoHS Exempt), or Green (RoHS & no Sb/Br) - please check <http://www.ti.com/productcontent> for the latest availability information and additional product content details.

TBD: The Pb-Free/Green conversion plan has not been defined.

Pb-Free (RoHS): TI's terms "Lead-Free" or "Pb-Free" mean semiconductor products that are compatible with the current RoHS requirements for all 6 substances, including the requirement that lead not exceed 0.1% by weight in homogeneous materials. Where designed to be soldered at high temperatures, TI Pb-Free products are suitable for use in specified lead-free processes.

Pb-Free (RoHS Exempt): This component has a RoHS exemption for either 1) lead-based flip-chip solder bumps used between the die and package, or 2) lead-based die adhesive used between the die and leadframe. The component is otherwise considered Pb-Free (RoHS compatible) as defined above.

Green (RoHS & no Sb/Br): TI defines "Green" to mean Pb-Free (RoHS compatible), and free of Bromine (Br) and Antimony (Sb) based flame retardants (Br or Sb do not exceed 0.1% by weight in homogeneous material)

⁽³⁾ MSL, Peak Temp. -- The Moisture Sensitivity Level rating according to the JEDEC industry standard classifications, and peak solder temperature.

Important Information and Disclaimer:The information provided on this page represents TI's knowledge and belief as of the date that it is provided. TI bases its knowledge and belief on information provided by third parties, and makes no representation or warranty as to the accuracy of such information. Efforts are underway to better integrate information from third parties. TI has taken and continues to take reasonable steps to provide representative and accurate information but may not have conducted destructive testing or chemical analysis on incoming materials and chemicals. TI and TI suppliers consider certain information to be proprietary, and thus CAS numbers and other limited information may not be available for release.

In no event shall TI's liability arising out of such information exceed the total purchase price of the TI part(s) at issue in this document sold by TI to Customer on an annual basis.

IMPORTANT NOTICE

Texas Instruments Incorporated and its subsidiaries (TI) reserve the right to make corrections, modifications, enhancements, improvements, and other changes to its products and services at any time and to discontinue any product or service without notice. Customers should obtain the latest relevant information before placing orders and should verify that such information is current and complete. All products are sold subject to TI's terms and conditions of sale supplied at the time of order acknowledgment.

TI warrants performance of its hardware products to the specifications applicable at the time of sale in accordance with TI's standard warranty. Testing and other quality control techniques are used to the extent TI deems necessary to support this warranty. Except where mandated by government requirements, testing of all parameters of each product is not necessarily performed.

TI assumes no liability for applications assistance or customer product design. Customers are responsible for their products and applications using TI components. To minimize the risks associated with customer products and applications, customers should provide adequate design and operating safeguards.

TI does not warrant or represent that any license, either express or implied, is granted under any TI patent right, copyright, mask work right, or other TI intellectual property right relating to any combination, machine, or process in which TI products or services are used. Information published by TI regarding third-party products or services does not constitute a license from TI to use such products or services or a warranty or endorsement thereof. Use of such information may require a license from a third party under the patents or other intellectual property of the third party, or a license from TI under the patents or other intellectual property of TI.

Reproduction of TI information in TI data books or data sheets is permissible only if reproduction is without alteration and is accompanied by all associated warranties, conditions, limitations, and notices. Reproduction of this information with alteration is an unfair and deceptive business practice. TI is not responsible or liable for such altered documentation. Information of third parties may be subject to additional restrictions.

Resale of TI products or services with statements different from or beyond the parameters stated by TI for that product or service voids all express and any implied warranties for the associated TI product or service and is an unfair and deceptive business practice. TI is not responsible or liable for any such statements.

TI products are not authorized for use in safety-critical applications (such as life support) where a failure of the TI product would reasonably be expected to cause severe personal injury or death, unless officers of the parties have executed an agreement specifically governing such use. Buyers represent that they have all necessary expertise in the safety and regulatory ramifications of their applications, and acknowledge and agree that they are solely responsible for all legal, regulatory and safety-related requirements concerning their products and any use of TI products in such safety-critical applications, notwithstanding any applications-related information or support that may be provided by TI. Further, Buyers must fully indemnify TI and its representatives against any damages arising out of the use of TI products in such safety-critical applications.

TI products are neither designed nor intended for use in military/aerospace applications or environments unless the TI products are specifically designated by TI as military-grade or "enhanced plastic." Only products designated by TI as military-grade meet military specifications. Buyers acknowledge and agree that any such use of TI products which TI has not designated as military-grade is solely at the Buyer's risk, and that they are solely responsible for compliance with all legal and regulatory requirements in connection with such use.

TI products are neither designed nor intended for use in automotive applications or environments unless the specific TI products are designated by TI as compliant with ISO/TS 16949 requirements. Buyers acknowledge and agree that, if they use any non-designated products in automotive applications, TI will not be responsible for any failure to meet such requirements.

Following are URLs where you can obtain information on other Texas Instruments products and application solutions:

Products

Amplifiers	amplifier.ti.com
Data Converters	dataconverter.ti.com
DLP® Products	www.dlp.com
DSP	dsp.ti.com
Clocks and Timers	www.ti.com/clocks
Interface	interface.ti.com
Logic	logic.ti.com
Power Mgmt	power.ti.com
Microcontrollers	microcontroller.ti.com
RFID	www.ti-rfid.com
RF/IF and ZigBee® Solutions	www.ti.com/lprf

Applications

Audio	www.ti.com/audio
Automotive	www.ti.com/automotive
Broadband	www.ti.com/broadband
Digital Control	www.ti.com/digitalcontrol
Medical	www.ti.com/medical
Military	www.ti.com/military
Optical Networking	www.ti.com/opticalnetwork
Security	www.ti.com/security
Telephony	www.ti.com/telephony
Video & Imaging	www.ti.com/video
Wireless	www.ti.com/wireless

Mailing Address: Texas Instruments, Post Office Box 655303, Dallas, Texas 75265
Copyright © 2009, Texas Instruments Incorporated