

Features

- Low-voltage Operation
 - 1.8V ($V_{CC} = 1.8V$ to 3.6V)
 - 2.5V ($V_{CC} = 2.5V$ to 5.5V)
- Internally Organized 131,072 x 8
- Two-wire Serial Interface
- Schmitt Triggers, Filtered Inputs for Noise Suppression
- Bidirectional Data Transfer Protocol
- 400 kHz (1.8V) and 1 MHz (5V, 2.5V) Clock Rate
- Write Protect Pin for Hardware and Software Data Protection
- 256-byte Page Write Mode (Partial Page Writes Allowed)
- Random and Sequential Read Modes
- Self-timed Write Cycle (5 ms Typical)
- High Reliability
 - Endurance: 1,000,000 Write Cycles/Page
 - Data Retention: 40 Years
- 8-lead PDIP, 8-lead JEDEC SOIC, 8-lead EIAJ SOIC, 8-lead TSSOP, 8-lead Ultra Thin Small Array (SAP), and 8-ball dBGA2 Packages
- Die Sales: Wafer Form, Tape and Reel and Bumped Die

Description

The AT24C1024B provides 1,048,576 bits of serial electrically erasable and programmable read only memory (EEPROM) organized as 131,072 words of 8 bits each. The device's cascadable feature allows up to four devices to share a common two-wire bus. The device is optimized for use in many industrial and commercial applications where low-power and low-voltage operation are essential. The devices are available in space-saving 8-lead PDIP, 8-lead JEDEC SOIC, 8-lead EIAJ SOIC, 8-lead TSSOP, 8-ball dBGA2 and 8-lead Ultra Thin SAP packages. In addition, the entire family is available in 1.8V (1.8V to 3.6V) and 2.5V (2.5V to 5.5V) versions.

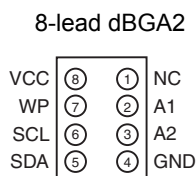
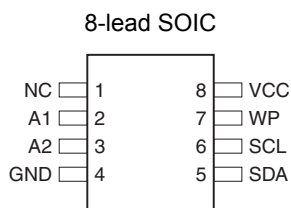

Bottom View

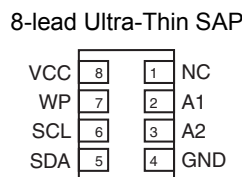
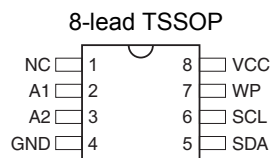
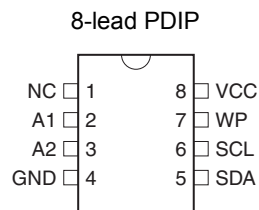

Bottom View



Two-wire Serial EEPROM

1M (131,072 x 8)

AT24C1024B with Two Device Address Inputs

Preliminary





Table 0-1. Pin Configurations

Pin Name	Function
A1	Address Input
A2	Address Input
SDA	Serial Data
SCL	Serial Clock Input
WP	Write Protect
NC	No Connect

1. Absolute Maximum Ratings*

Operating Temperature.....	-55°C to +125°C
Storage Temperature	-65°C to +150°C
Voltage on Any Pin with Respect to Ground	-1.0V to +7.0V
Maximum Operating Voltage	6.25V
DC Output Current.....	5.0 mA

*NOTICE: Stresses beyond those listed under “Absolute Maximum Ratings” may cause permanent damage to the device. This is a stress rating only and functional operation of the device at these or any other conditions beyond those indicated in the operational sections of this specification is not implied. Exposure to absolute maximum rating conditions for extended periods may affect device reliability.

Figure 1-1. Block Diagram

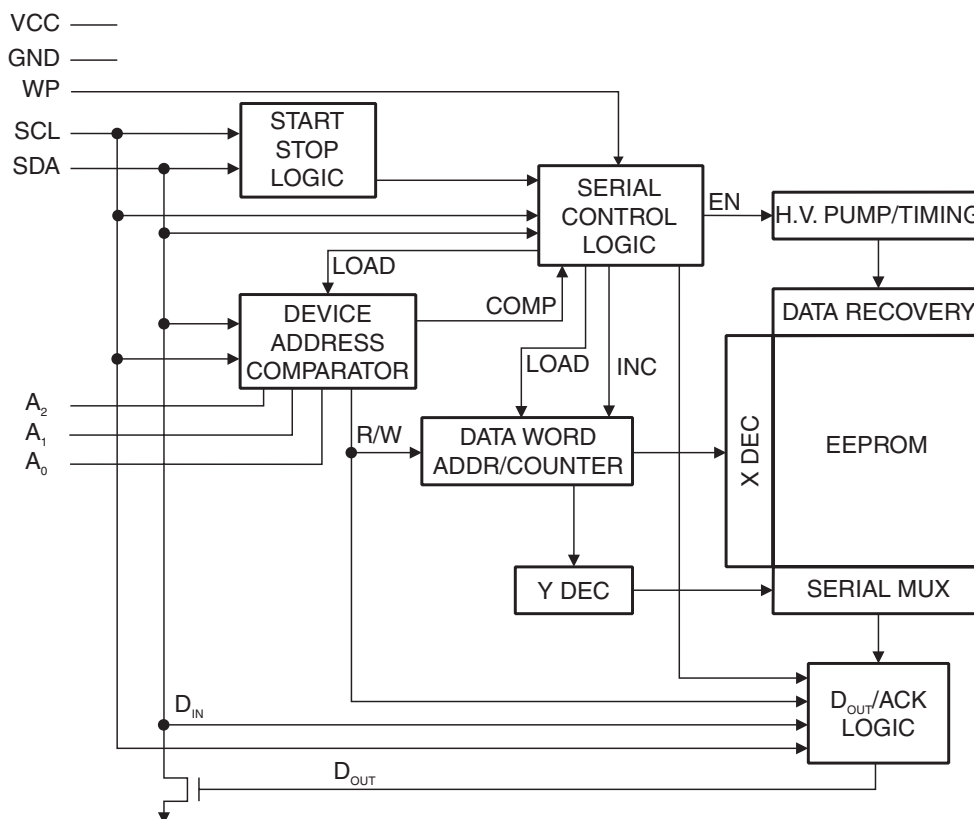

2. Pin Description

SERIAL CLOCK (SCL): The SCL input is used to positive edge clock data into each EEPROM device and negative edge clock data out of each device.

SERIAL DATA (SDA): The SDA pin is bi-directional for serial data transfer. This pin is open-drain driven and may be wire-ORed with any number of other open-drain or open-collector devices.

DEVICE/ADDRESSES (A1/A2): The A1, A2 pin is a device address input that can be hardwired or left not connected for hardware compatibility with other AT24Cxx devices. When the A1, A2 pins are hardwired, as many as four 1024K devices may be addressed on a single bus system (device addressing is discussed in detail under the Device Addressing section). If the A1/A2 pins are left floating, the A1/A2 pin will be internally pulled down to GND if the capacitive coupling to the circuit board V_{CC} plane is <3 pF. If coupling is >3 pF, Atmel recommends connecting the A1/A2 pin to GND.

WRITE PROTECT (WP): The write protect input, when connected to GND, allows normal write operations. When WP is connected high to V_{CC} , all write operations to the memory are inhibited. If the pin is left floating, the WP pin will be internally pulled down to GND if the capacitive coupling to the circuit board V_{CC} plane is <3 pF. If coupling is >3 pF, Atmel recommends connecting the pin to GND. Switching WP to V_{CC} prior to a write operation creates a software write-protect function.

3. Memory Organization

AT24C1024B, 1024K SERIAL EEPROM: The 1024K is internally organized as 512 pages of 256 bytes each. Random word addressing requires a 17-bit data word address.

Table 3-1. Pin Capacitance⁽¹⁾

Applicable over recommended operating range from $T_A = 25^\circ\text{C}$, $f = 1.0\text{ MHz}$, $V_{CC} = +1.8\text{V}$

Symbol	Test Condition	Max	Units	Conditions
$C_{I/O}$	Input/Output Capacitance (SDA)	8	pF	$V_{I/O} = 0\text{V}$
C_{IN}	Input Capacitance (A_1 , SCL)	6	pF	$V_{IN} = 0\text{V}$

Note: 1. This parameter is characterized and is not 100% tested.

Table 3-2. DC Characteristics

Applicable over recommended operating range from: $T_{AI} = -40^\circ\text{C}$ to $+85^\circ\text{C}$, $V_{CC} = +1.8\text{V}$ to $+5.5\text{V}$ (unless otherwise noted)

Symbol	Parameter	Test Condition		Min	Typ	Max	Units
V_{CC1}	Supply Voltage			1.8		3.6	V
V_{CC2}	Supply Voltage			2.5		5.5	V
I_{CC}	Supply Current	$V_{CC} = 5.0\text{V}$	READ at 400 kHz			2.0	mA
I_{CC}	Supply Current	$V_{CC} = 5.0\text{V}$	WRITE at 400 kHz			3.0	mA
I_{SB1}	Standby Current	$V_{CC} = 1.8\text{V}$	$V_{IN} = V_{CC}$ or V_{SS}			1.0	μA
		$V_{CC} = 3.6\text{V}$				3.0	μA
I_{SB2}	Standby Current	$V_{CC} = 2.5\text{V}$	$V_{IN} = V_{CC}$ or V_{SS}			2.0	μA
		$V_{CC} = 5.5\text{V}$				6.0	μA
I_{LI}	Input Leakage Current	$V_{IN} = V_{CC}$ or V_{SS}			0.10	3.0	μA
I_{LO}	Output Leakage Current	$V_{OUT} = V_{CC}$ or V_{SS}			0.05	3.0	μA
V_{IL}	Input Low Level ⁽¹⁾			-0.6		$V_{CC} \times 0.3$	V
V_{IH}	Input High Level ⁽¹⁾			$V_{CC} \times 0.7$		$V_{CC} + 0.5$	V
V_{OL1}	Output Low Level	$V_{CC} = 1.8\text{V}$	$I_{OL} = 0.15\text{ mA}$			0.2	V
V_{OL2}	Output Low Level	$V_{CC} = 3.0\text{V}$	$I_{OL} = 2.1\text{ mA}$			0.4	V

Note: 1. V_{IL} min and V_{IH} max are reference only and are not tested.

Table 3-3. AC Characteristics (Industrial Temperature)

Applicable over recommended operating range from $T_{AI} = -40^\circ\text{C}$ to $+85^\circ\text{C}$, $V_{CC} = +1.8\text{V}$ to $+3.6\text{V}$, $CL = 100\text{ pF}$ (unless otherwise noted). Test conditions are listed in Note 2.

Symbol	Parameter	1.8-volt		2.5, 5.0-volt		Units
		Min	Max	Min	Max	
f_{SCL}	Clock Frequency, SCL		400		1000	kHz
t_{LOW}	Clock Pulse Width Low	1.3		0.4		μs
t_{HIGH}	Clock Pulse Width High	0.6		0.4		μs

Table 3-3. AC Characteristics (Industrial Temperature)

Applicable over recommended operating range from $T_{AI} = -40^{\circ}\text{C}$ to $+85^{\circ}\text{C}$, $V_{CC} = +1.8\text{V}$ to $+3.6\text{V}$, $CL = 100\text{ pF}$ (unless otherwise noted). Test conditions are listed in Note 2.

Symbol	Parameter	1.8-volt		2.5, 5.0-volt		Units
		Min	Max	Min	Max	
t_i	Noise Suppression Time ⁽¹⁾		100		50	ns
t_{AA}	Clock Low to Data Out Valid	0.05	0.9	0.05	0.55	μs
t_{BUF}	Time the bus must be free before a new transmission can start ⁽¹⁾	1.3		0.5		μs
$t_{HD,STA}$	Start Hold Time	0.6		0.25		μs
$t_{SU,STA}$	Start Set-up Time	0.6		0.25		μs
$t_{HD,DAT}$	Data In Hold Time	0		0		μs
$t_{SU,DAT}$	Data In Set-up Time	100		100		ns
t_R	Inputs Rise Time ⁽¹⁾		0.3		0.3	μs
t_F	Inputs Fall Time ⁽¹⁾		300		100	ns
$t_{SU,STO}$	Stop Set-up Time	0.6		0.25		μs
t_{DH}	Data Out Hold Time	50		50		ns
t_{WR}	Write Cycle Time		5		5	ms
Endurance ⁽¹⁾	25°C, Page Mode, 3.3V	1,000,000				Write Cycles

- Notes:
1. This parameter is ensured by characterization only.
 2. AC measurement conditions:
 R_L (connects to V_{CC}): 1.3 k Ω (2.5V, 5V), 10 k Ω (1.8V)
 Input pulse voltages: 0.3 V_{CC} to 0.7 V_{CC}
 Input rise and fall times: $\leq 50\text{ ns}$
 Input and output timing reference voltages: 0.5 V_{CC}

4. Device Operation

CLOCK and DATA TRANSITIONS: The SDA pin is normally pulled high with an external device. Data on the SDA pin may change only during SCL low time periods (see [Figure 4-4 on page 7](#)). Data changes during SCL high periods will indicate a start or stop condition as defined below.

START CONDITION: A high-to-low transition of SDA with SCL high is a start condition which must precede any other command (see [Figure 4-5 on page 8](#)).

STOP CONDITION: A low-to-high transition of SDA with SCL high is a stop condition. After a read sequence, the Stop command will place the EEPROM in a standby power mode (see [Figure 4-5 on page 8](#)).

ACKNOWLEDGE: All addresses and data words are serially transmitted to and from the EEPROM in 8-bit words. The EEPROM sends a zero during the ninth clock cycle to acknowledge that it has received each word.

STANDBY MODE: The AT24C1024B features a low-power standby mode which is enabled: a) upon power-up and b) after the receipt of the stop bit and the completion of any internal operations.

SOFTWARE RESET: After an interruption in protocol, power loss or system reset, any 2-wire part can be protocol reset by following these steps: (a) Create a start bit condition, (b) clock 9 cycles, (c) create another start bit followed by stop bit condition as shown below. The device is ready for next communication after above steps have been completed.

Figure 4-1. Software Reset

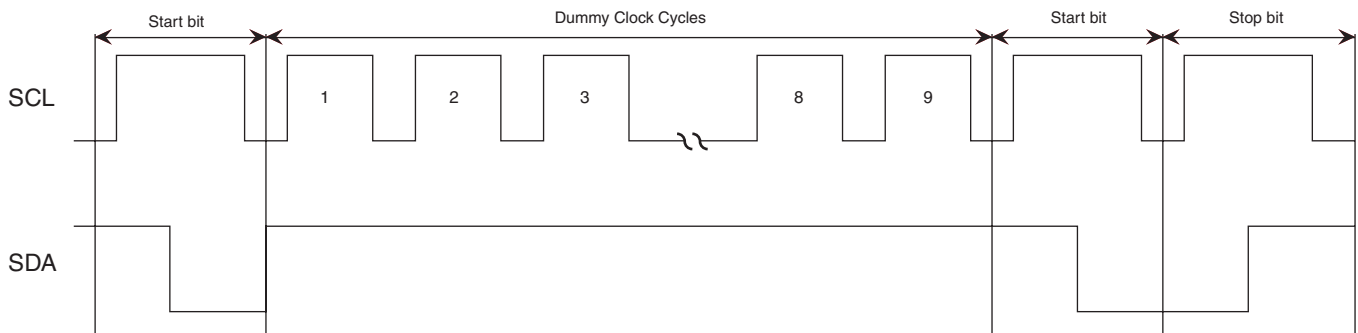

Figure 4-2. Bus Timing (SCL: Serial Clock, SDA: Serial Data I/O[®])

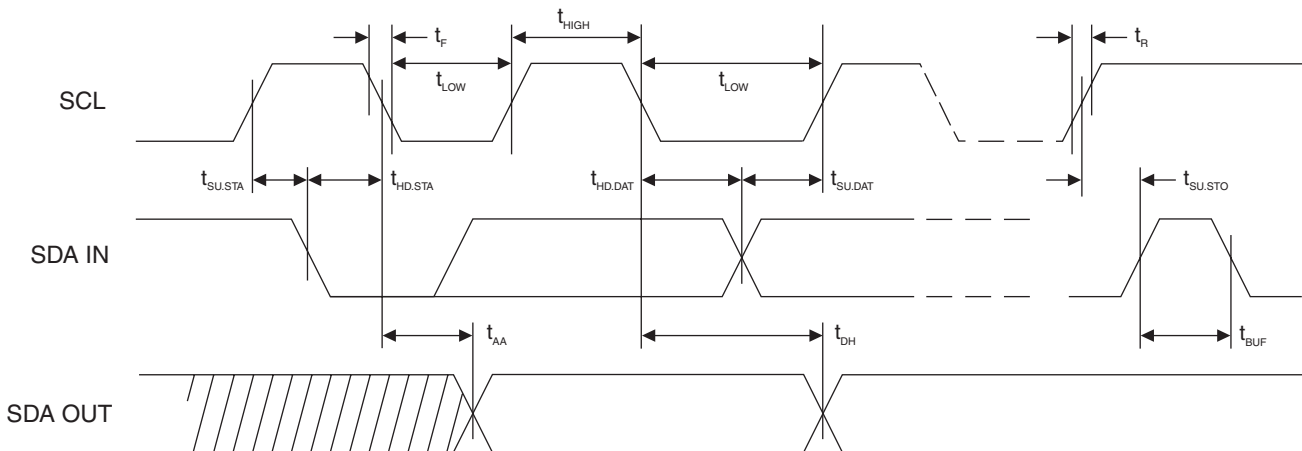
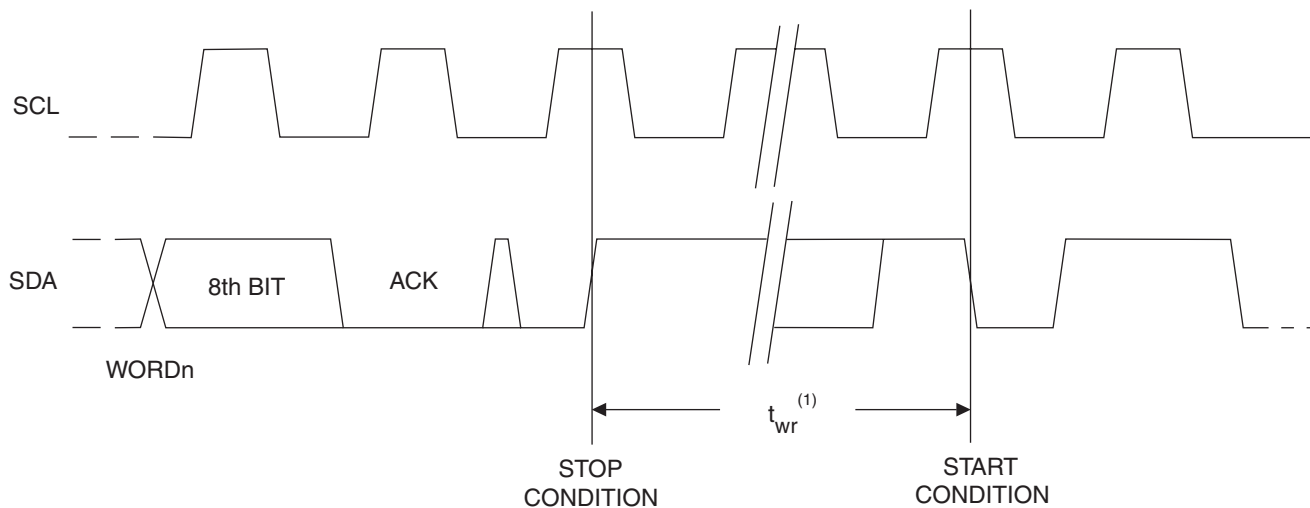

Figure 4-3. Write Cycle Timing (SCL: Serial Clock, SDA: Serial Data I/O)



Note: 1. The write cycle time t_{wr} is the time from a valid stop condition of a write sequence to the end of the internal clear/write cycle.

Figure 4-4. Data Validity

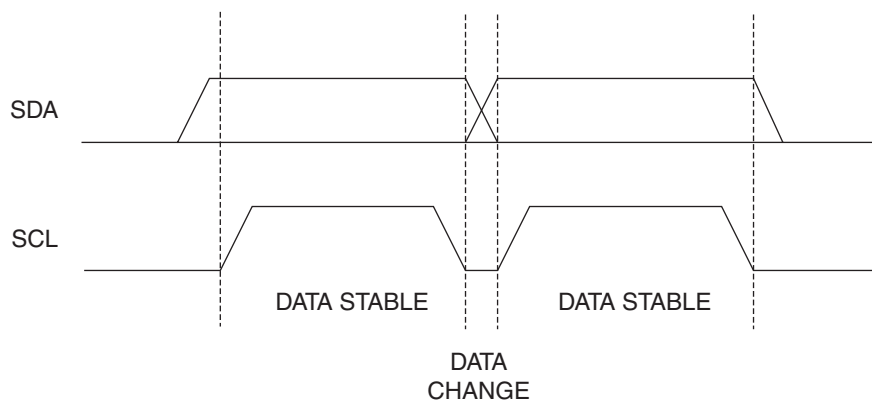

Figure 4-5. Start and Stop Definition

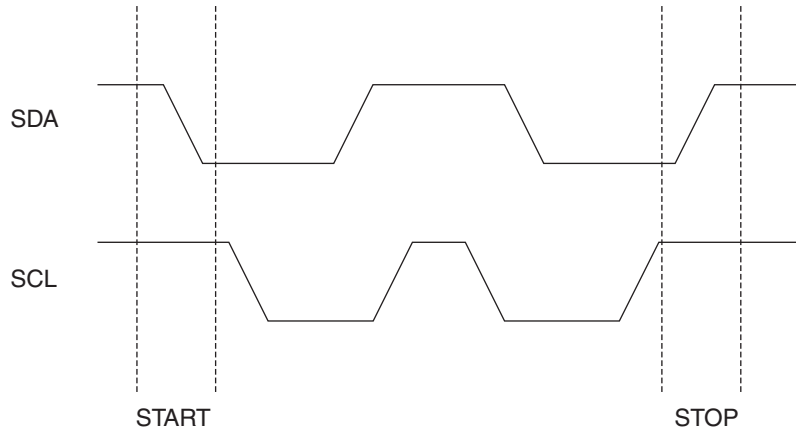
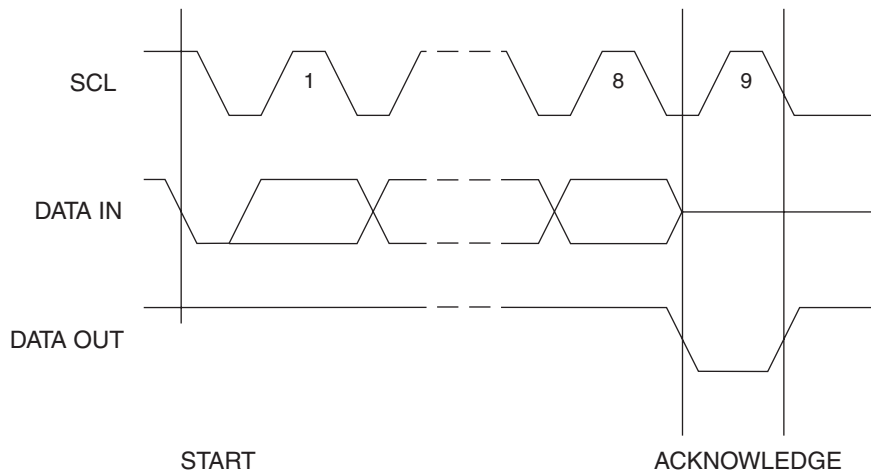

Figure 4-6. Output Acknowledge



5. Device Addressing

The 1024K EEPROM requires an 8-bit device address word following a start condition to enable the chip for a read or write operation (see [Figure 7-1 on page 11](#)). The device address word consists of a mandatory one, zero sequence for the first four most significant bits as shown. This is common to all two-wire EEPROM devices.

The 1024K uses the two device address bit, A1, A2, to allow up to four devices on the same bus. These A1, A2 bits must compare to the corresponding hardwired input pins. The A1, A2 pin uses an internal proprietary circuit that biases it to a logic low condition if the pin is allowed to float.

The seventh bit (P_0) of the device address is a memory page address bit. This memory page address bit is the most significant bit of the data word address that follows. The eighth bit of the device address is the read/write operation select bit. A read operation is initiated if this bit is high and a write operation is initiated if this bit is low.

Upon a compare of the device address, the EEPROM will output a zero. If a compare is not made, the device will return to a standby state.

DATA SECURITY: The AT24C1024B has a hardware data protection scheme that allows the user to write-protect the entire memory when the WP pin is at V_{CC} .

6. Write Operations

BYTE WRITE: To select a data word in the 1024K memory requires a 17-bit word address. The word address field consists of the P_0 bit of the device address, then the most significant word address followed by the least significant word address (see [Figure 7-2 on page 11](#))

A write operation requires the P_0 bit and two 8-bit data word addresses following the device address word and acknowledgment. Upon receipt of this address, the EEPROM will again respond with a zero and then clock in the first 8-bit data word. Following receipt of the 8-bit data word, the EEPROM will output a zero. The addressing device, such as a microcontroller, then must terminate the write sequence with a stop condition. At this time the EEPROM enters an internally timed write cycle, T_{WR} , to the nonvolatile memory. All inputs are disabled during this write cycle and the EEPROM will not respond until the write is complete (see [Figure 7-2 on page 11](#)).

PAGE WRITE: The 1024K EEPROM is capable of 256-byte page writes.

A page write is initiated the same way as a byte write, but the microcontroller does not send a stop condition after the first data word is clocked in. Instead, after the EEPROM acknowledges receipt of the first data word, the microcontroller can transmit up to 255 more data words. The EEPROM will respond with a zero after each data word received. The microcontroller must terminate the page write sequence with a stop condition (see [Figure 7-3 on page 11](#)).

The data word address lower 8 bits are internally incremented following the receipt of each data word. The higher data word address bits are not incremented, retaining the memory page row location. When the word address, internally generated, reaches the page boundary, the following byte is placed at the beginning of the same page. If more than 256 data words are transmitted to the EEPROM, the data word address will “roll over” and previous data will be overwritten. The address “rollover” during write is from the last byte of the current page to the first byte of the same page.

ACKNOWLEDGE POLLING: Once the internally timed write cycle has started and the EEPROM inputs are disabled, acknowledge polling can be initiated. This involves sending a start condition followed by the device address word. The read/write bit is representative of the operation desired. Only if the internal write cycle has completed will the EEPROM respond with a zero, allowing the read or write sequence to continue.

7. Read Operations

Read operations are initiated the same way as write operations with the exception that the read/write select bit in the device address word is set to one. There are three read operations: current address read, random address read and sequential read.

CURRENT ADDRESS READ: The internal data word address counter maintains the last address accessed during the last read or write operation, incremented by one. This address stays valid between operations as long as the chip power is maintained. The address “rollover” during read is from the last byte of the last memory page, to the first byte of the first page.

Once the device address with the read/write select bit set to one is clocked in and acknowledged by the EEPROM, the current address data word is serially clocked out. The microcontroller does not respond with an input zero but does generate a following stop condition (see [Figure 7-4 on page 11](#)).

RANDOM READ: A random read requires a “dummy” byte write sequence to load in the data word address. Once the device address word and data word address are clocked in and acknowledged by the EEPROM, the microcontroller must generate another start condition. The microcontroller now initiates a current address read by sending a device address with the read/write select bit high. The EEPROM acknowledges the device address and serially clocks out the data word. The microcontroller does not respond with a zero but does generate a following stop condition (see [Figure 7-5 on page 12](#)).

SEQUENTIAL READ: Sequential reads are initiated by either a current address read or a random address read. After the microcontroller receives a data word, it responds with an acknowledge. As long as the EEPROM receives an acknowledge, it will continue to increment the data word address and serially clock out sequential data words. When the memory address limit is reached, the data word address will “roll over” and the sequential read will continue. The sequential read operation is terminated when the microcontroller does not respond with a zero, but does generate a following stop condition (see [Figure 7-6 on page 12](#)).

Figure 7-1. Device Address

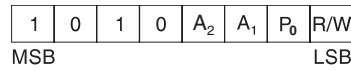

Figure 7-2. Byte Write

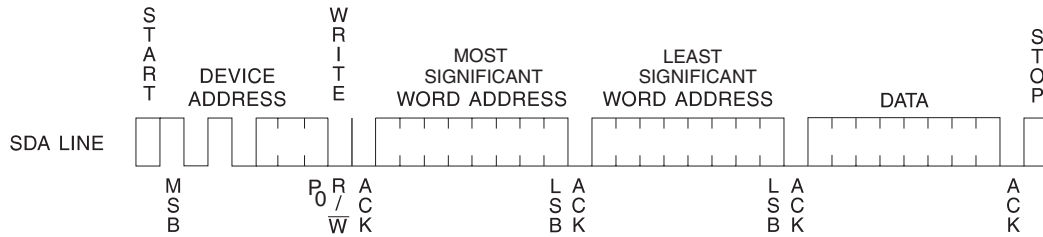

Figure 7-3. Page Write

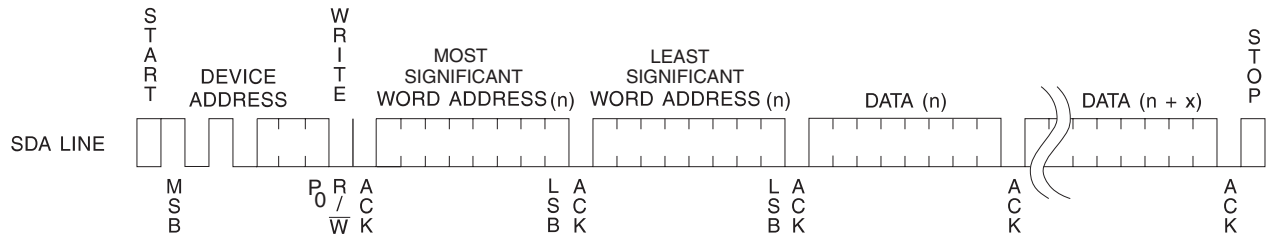

Figure 7-4. Current Address Read

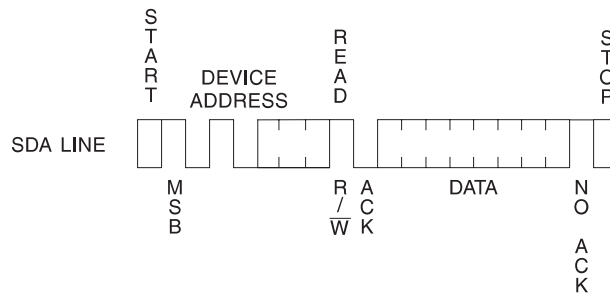

Figure 7-5. Random Read

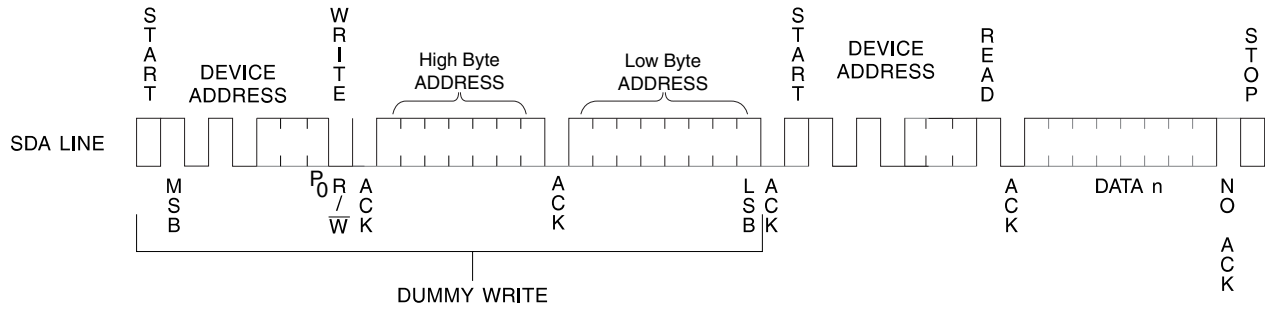
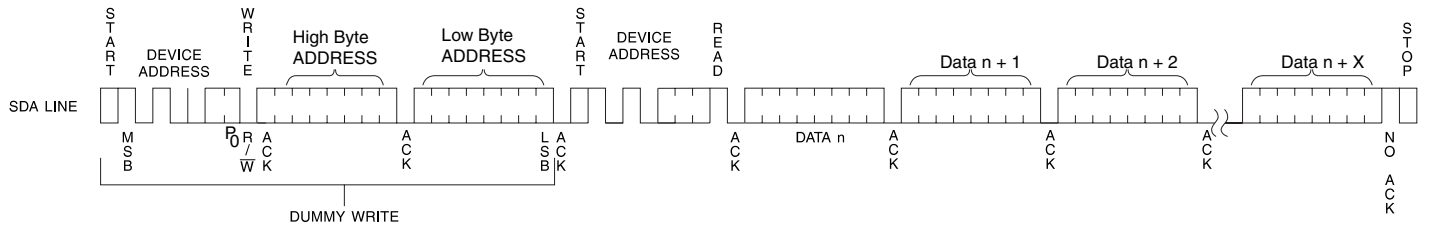

Figure 7-6. Sequential Read



Ordering Information

Ordering Code	Voltage	Package	Operation Range
AT24C1024B-PU (Bulk form only)	1.8	8P3	Lead-free/Halogen-free/ Industrial Temperature (-40°C to 85°C)
AT24C1024B-PU25 (Bulk form only)	2.5	8P3	
AT24C1024BN-SH-B ⁽¹⁾ (NiPdAu Lead Finish)	1.8	8S1	
AT24C1024BN-SH-T ⁽²⁾ (NiPdAu Lead Finish)	1.8	8S1	
AT24C1024BN-SH25-B ⁽¹⁾ (NiPdAu Lead Finish)	2.5	8S1	
AT24C1024BN-SH25-T ⁽²⁾ (NiPdAu Lead Finish)	2.5	8S1	
AT24C1024BW-SH-B ⁽¹⁾ (NiPdAu Lead Finish)	1.8	8S2	
AT24C1024BW-SH-T ⁽²⁾ (NiPdAu Lead Finish)	1.8	8S2	
AT24C1024BW-SH25-B ⁽¹⁾ (NiPdAu Lead Finish)	2.5	8S2	
AT24C1024BW-SH25-T ⁽²⁾ (NiPdAu Lead Finish)	2.5	8S2	
AT24C1024B-TH-B ⁽¹⁾ (NiPdAu Lead Finish)	1.8	8A2	
AT24C1024B-TH-T ⁽²⁾ (NiPdAu Lead Finish)	1.8	8A2	
AT24C1024B-TH25-B ⁽¹⁾ (NiPdAu Lead Finish)	2.5	8A2	
AT24C1024B-TH25-T ⁽²⁾ (NiPdAu Lead Finish)	2.5	8A2	
AT24C1024BY7-YH-T ⁽²⁾ (NiPdAu Lead Finish)	1.8	8Y7	
AT24C1024BY7-YH25-T ⁽²⁾ (NiPdAu Lead Finish)	2.5	8Y7	
AT24C1024BU4-UU-T ⁽²⁾ (NiPdAu Lead Finish)	1.8	8U4-1	
AT24C1024B-W-11 ⁽³⁾	1.8	Die Sale	Industrial Temperature (-40°C to 85°C)

- Notes:
1. "-B" denotes bulk
 2. "-T" denotes tape and reel. SOIC = 4K per reel. TSSOP and dBGA2 = 5K per reel. SAP = 3K per reel. EIAJ = 2K per reel.
 3. Available in tape and reel and wafer form; order as SL788 for inkless wafer form. Bumped die available upon request. Please contact Serial Interface Marketing.

Package Type	
8P3	8-lead, 0.300" Wide, Plastic Dual In-line Package (PDIP)
8S1	8-lead, 0.150" Wide, Plastic Gull Wing Small Outline Package (JEDEC SOIC)
8S2	8-lead, 0.200" Wide Plastic Gull Wing Small Outline Package (EIAJ SOIC)
8A2	8-lead, 4.4 mm Body, Plastic Thin Shrink Small Outline Package (TSSOP)
8Y7	8-lead, 6.00 mm x 4.90 mm Body, Ultra Thin, Dual Footprint, Non-leaded, Small Array Package (SAP)
8U4-1	8-ball, die Ball Grid Array Package (dBGA2)
Options	
-1.8	Low-voltage (1.8V to 3.6V)
-2.5	Low-voltage (2.5V to 5.5V)

8. Part marking scheme

8.1 8-SOIC(1.8V)

TOP MARK	Seal Year	Y = SEAL YEAR	WW = SEAL WEEK
	Seal Week	6: 2006 0: 2010	02 = Week 2
		7: 2007 1: 2011	04 = Week 4
--- --- --- --- --- --- --- ---		8: 2008 2: 2012	:: : :::: :
A T M L H Y W W		9: 2009 3: 2013	:: : :::: ::
--- --- --- --- --- --- --- ---			50 = Week 50
2 G B 1			52 = Week 52
--- --- --- --- --- --- --- ---			
* Lot Number			
--- --- --- --- --- --- --- ---			
Pin 1 Indicator (Dot)			

Lot Number to Use ALL Characters in Marking

BOTTOM MARK

No Bottom Mark

8.2 8-SOIC(2.5V)

TOP MARK	Seal Year	Y = SEAL YEAR	WW = SEAL WEEK
	Seal Week	6: 2006 0: 2010	02 = Week 2
		7: 2007 1: 2011	04 = Week 4
--- --- --- --- --- --- --- ---		8: 2008 2: 2012	:: : :::: :
A T M L H Y W W		9: 2009 3: 2013	:: : :::: ::
--- --- --- --- --- --- --- ---			50 = Week 50
2 G B 2			52 = Week 52
--- --- --- --- --- --- --- ---			
* Lot Number			
--- --- --- --- --- --- --- ---			
Pin 1 Indicator (Dot)			

Lot Number to Use ALL Characters in Marking

BOTTOM MARK

No Bottom Mark

8.3 8-TSSOP(1.8V)

TOP MARK

```

Pin 1 Indicator (Dot)
|
|---|---|---|---|
*  H  Y  W  W
|---|---|---|---|
  2  G  B      1
|---|---|---|---|
    
```

```

Y = SEAL YEAR
6: 2006   0: 2010
7: 2007   1: 2011
8: 2008   2: 2012
9: 2009   3: 2013
    
```

```

WW = SEAL WEEK
02 = Week 2
04 = Week 4
:: : :::: :
:: : :::: ::
50 = Week 50
52 = Week 52
    
```

BOTTOM MARK

```

|---|---|---|---|---|---|---|
P   H
|---|---|---|---|---|---|---|
A   A   A   A   A   A   A
|---|---|---|---|---|---|---|
<- Pin 1 Indicator
    
```

8.4 8-TSSOP(2.5V)

TOP MARK

```

Pin 1 Indicator (Dot)
|
|---|---|---|---|
*  H  Y  W  W
|---|---|---|---|
  2  G  B      2
|---|---|---|---|
    
```

```

Y = SEAL YEAR
6: 2006   0: 2010
7: 2007   1: 2011
8: 2008   2: 2012
9: 2009   3: 2013
    
```

```

WW = SEAL WEEK
02 = Week 2
04 = Week 4
:: : :::: :
:: : :::: ::
50 = Week 50
52 = Week 52
    
```

BOTTOM MARK

```

|---|---|---|---|---|---|---|
P   H
|---|---|---|---|---|---|---|
A   A   A   A   A   A   A
|---|---|---|---|---|---|---|
<- Pin 1 Indicator
    
```



8.5 8-PDIP(1.8V)

TOP MARK

Seal Year							
				Seal Week			
---	---	---	---	---	---	---	---
A	T	M	L	U	Y	W	W
---	---	---	---	---	---	---	---
2	G	B		1			
---	---	---	---	---	---	---	---
*	Lot Number						
---	---	---	---	---	---	---	---

Pin 1 Indicator (Dot)

Y = SEAL YEAR

6: 2006	0: 2010
7: 2007	1: 2011
8: 2008	2: 2012
9: 2009	3: 2013

WW = SEAL WEEK

02 = Week 2
04 = Week 4
:: : :::: :
:: : :::: ::
50 = Week 50
52 = Week 52

Lot Number to Use ALL Characters in Marking

BOTTOM MARK

No Bottom Mark

8.6 8-PDIP(2.5V)

TOP MARK

Seal Year							
				Seal Week			
---	---	---	---	---	---	---	---
A	T	M	L	U	Y	W	W
---	---	---	---	---	---	---	---
2	G	B		2			
---	---	---	---	---	---	---	---
*	Lot Number						
---	---	---	---	---	---	---	---

Pin 1 Indicator (Dot)

Y = SEAL YEAR

6: 2006	0: 2010
7: 2007	1: 2011
8: 2008	2: 2012
9: 2009	3: 2013

WW = SEAL WEEK

02 = Week 2
04 = Week 4
:: : :::: :
:: : :::: ::
50 = Week 50
52 = Week 52

Lot Number to Use ALL Characters in Marking

BOTTOM MARK

No Bottom Mark

8.7 8-Ultra Thin SAP (1.8V)

TOP MARK

Seal Year							
				Seal Week			
---	---	---	---	---	---	---	---
A	T	M	L	H	Y	W	W
---	---	---	---	---	---	---	---
2	G	B		1			
---	---	---	---	---	---	---	---
Lot Number							
---	---	---	---	---	---	---	---
*							

Pin 1 Indicator (Dot)

Y = SEAL YEAR

6: 2006	0: 2010
7: 2007	1: 2011
8: 2008	2: 2012
9: 2009	3: 2013

WW = SEAL WEEK

02 = Week 2
04 = Week 4
:: : :::: :
:: : :::: ::
50 = Week 50
52 = Week 52

8.8 8-Ultra Thin SAP (2.5V)

TOP MARK	Seal Year	Y = SEAL YEAR	WW = SEAL WEEK
	Seal Week	6: 2006 0: 2010	02 = Week 2
		7: 2007 1: 2011	04 = Week 4
--- --- --- --- --- --- --- ---		8: 2008 2: 2012	:: : :::: :
A T M L H Y W W		9: 2009 3: 2013	:: : :::: ::
--- --- --- --- --- --- --- ---			50 = Week 50
2 G B 2			52 = Week 52
--- --- --- --- --- --- --- ---			
Lot Number			
--- --- --- --- --- --- --- ---			
*			
Pin 1 Indicator (Dot)			

8.9 dBGA2

TOP MARK

LINE 1-----> 2GBU
 LINE 2-----> PYMTC
 |<-- Pin 1 This Corner

P = COUNTRY OF ORIGIN
 Y = ONE DIGIT YEAR CODE
 4: 2004 7: 2007
 5: 2005 8: 2008
 6: 2006 9: 2009

M = SEAL MONTH (USE ALPHA DESIGNATOR A-L)
 A = JANUARY
 B = FEBRUARY
 " " " " " " " " " " " "
 J = OCTOBER
 K = NOVEMBER
 L = DECEMBER

TC = TRACE CODE (ATMEL LOT
 NUMBERS TO CORRESPOND
 WITH ATK TRACE CODE LOG BOOK)



9. Packaging Information

8P3 – PDIP

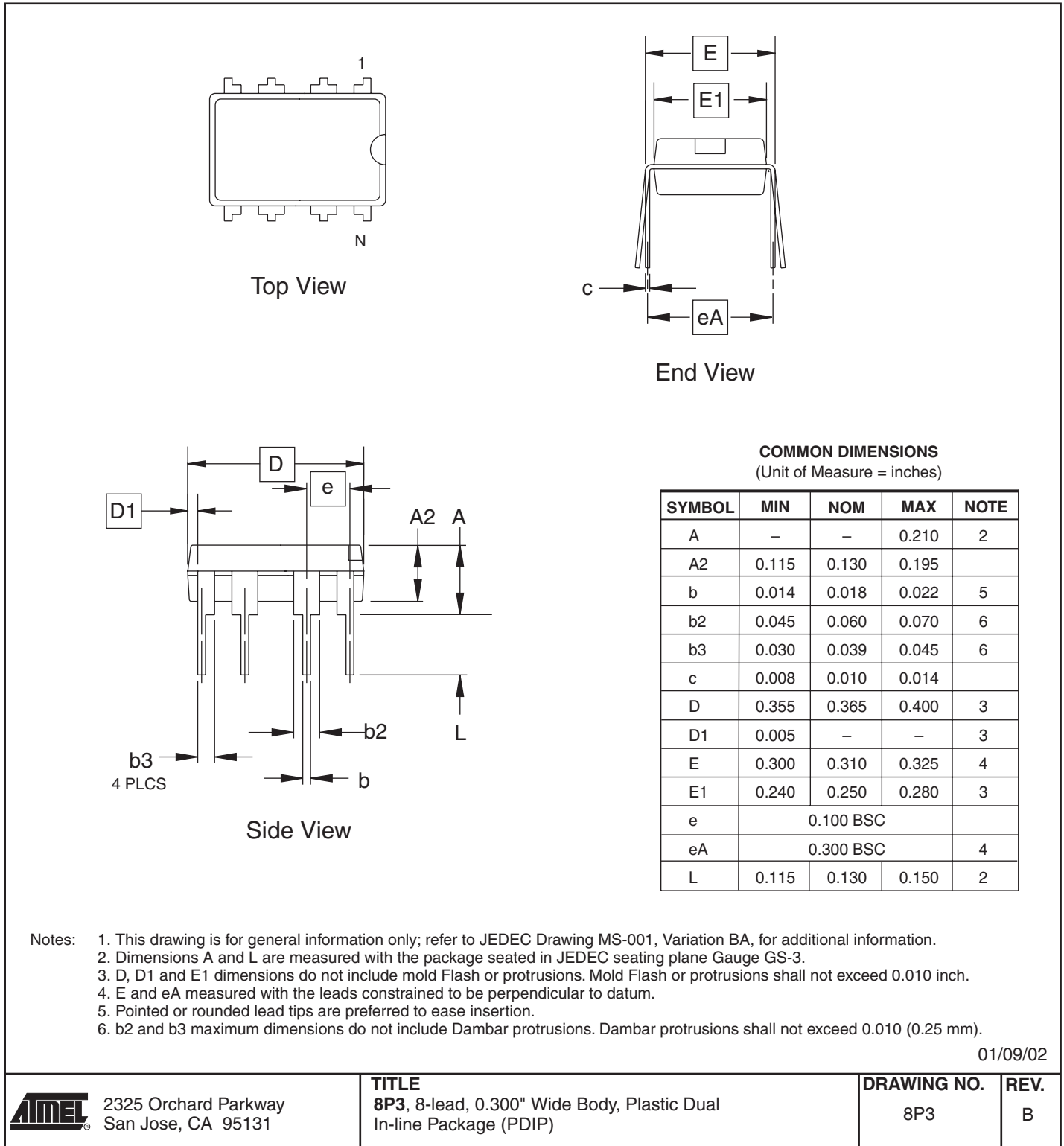

8S1 - JEDEC SOIC

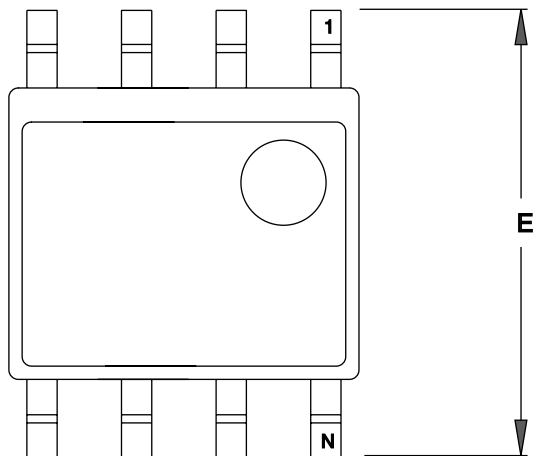

TOP VIEW

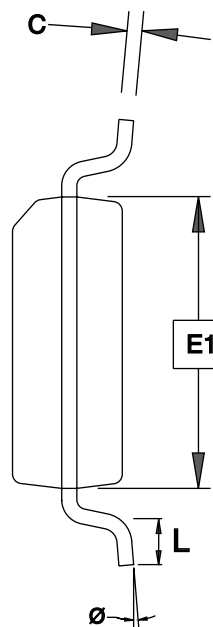

END VIEW

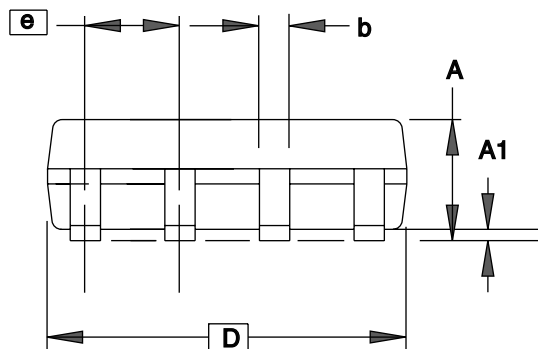

SIDE VIEW

COMMON DIMENSIONS
(Unit of Measure = mm)

SYMBOL	MIN	NOM	MAX	NOTE
A	1.35	–	1.75	
A1	0.10	–	0.25	
b	0.31	–	0.51	
C	0.17	–	0.25	
D	4.80	–	5.05	
E1	3.81	–	3.99	
E	5.79	–	6.20	
e	1.27 BSC			
L	0.40	–	1.27	
θ	0°	–	8°	

Note: These drawings are for general information only. Refer to JEDEC Drawing MS-012, Variation AA for proper dimensions, tolerances, datums, etc.

3/17/05



1150 E. Cheyenne Mtn. Blvd.
Colorado Springs, CO 80906

TITLE
8S1, 8-lead (0.150" Wide Body), Plastic Gull Wing
Small Outline (JEDEC SOIC)

DRAWING NO.
8S1

REV.
C

8S2 – EIAJ SOIC

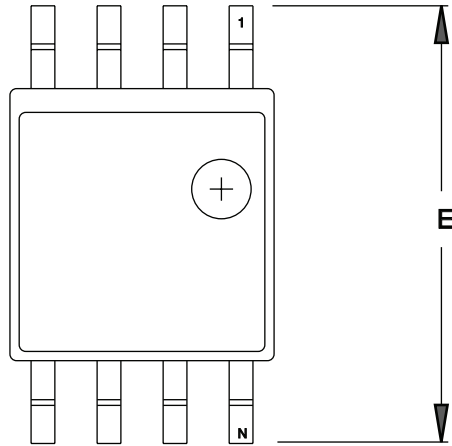

TOP VIEW

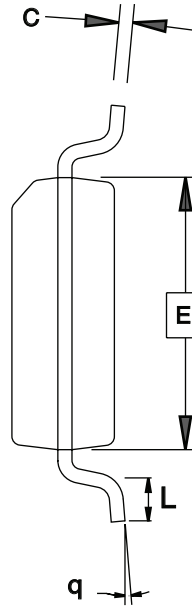

END VIEW

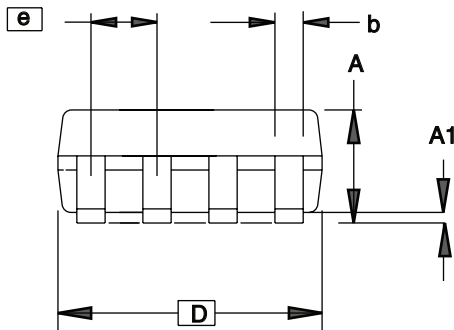

SIDE VIEW

COMMON DIMENSIONS
(Unit of Measure = mm)

SYMBOL	MIN	NOM	MAX	NOTE
A	1.70		2.16	
A1	0.05		0.25	
b	0.35		0.48	5
C	0.15		0.35	5
D	5.13		5.35	
E1	5.18		5.40	2, 3
E	7.70		8.26	
L	0.51		0.85	
q	0°		8°	
e	1.27 BSC			4

- Notes: 1. This drawing is for general information only; refer to EIAJ Drawing EDR-7320 for additional information.
 2. Mismatch of the upper and lower dies and resin burrs aren't included.
 3. It is recommended that upper and lower cavities be equal. If they are different, the larger dimension shall be regarded.
 4. Determines the true geometric position.
 5. Values b,C apply to plated terminal. The standard thickness of the plating layer shall measure between 0.007 to .021 mm.

4/7/06



2325 Orchard Parkway
San Jose, CA 95131

TITLE
8S2, 8-lead, 0.209" Body, Plastic Small
Outline Package (EIAJ)

DRAWING NO.
8S2

REV.
D

8A2 - TSSOP

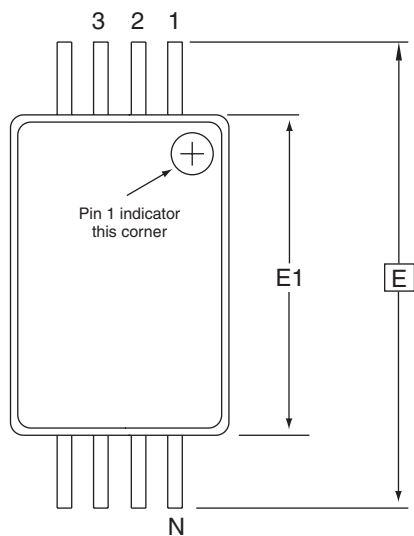

Top View

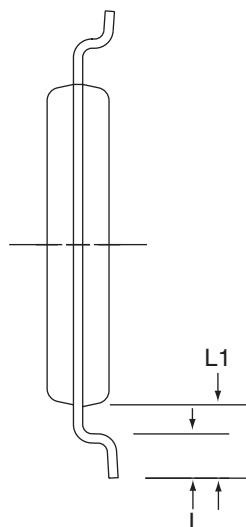

End View

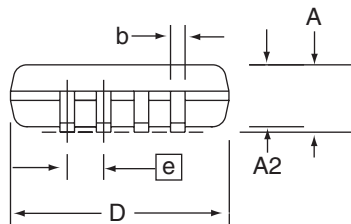

Side View

COMMON DIMENSIONS
(Unit of Measure = mm)

SYMBOL	MIN	NOM	MAX	NOTE
D	2.90	3.00	3.10	2, 5
E	6.40 BSC			
E1	4.30	4.40	4.50	3, 5
A	-	-	1.20	
A2	0.80	1.00	1.05	
b	0.19	-	0.30	4
e	0.65 BSC			
L	0.45	0.60	0.75	
L1	1.00 REF			

- Notes:
1. This drawing is for general information only. Refer to JEDEC Drawing MO-153, Variation AA, for proper dimensions, tolerances, datums, etc.
 2. Dimension D does not include mold Flash, protrusions or gate burrs. Mold Flash, protrusions and gate burrs shall not exceed 0.15 mm (0.006 in) per side.
 3. Dimension E1 does not include inter-lead Flash or protrusions. Inter-lead Flash and protrusions shall not exceed 0.25 mm (0.010 in) per side.
 4. Dimension b does not include Dambar protrusion. Allowable Dambar protrusion shall be 0.08 mm total in excess of the b dimension at maximum material condition. Dambar cannot be located on the lower radius of the foot. Minimum space between protrusion and adjacent lead is 0.07 mm.
 5. Dimension D and E1 to be determined at Datum Plane H.

5/30/02



2325 Orchard Parkway
San Jose, CA 95131

TITLE

8A2, 8-lead, 4.4 mm Body, Plastic
Thin Shrink Small Outline Package (TSSOP)

DRAWING NO.

8A2

REV.

B

8U4-1 - dBGA2

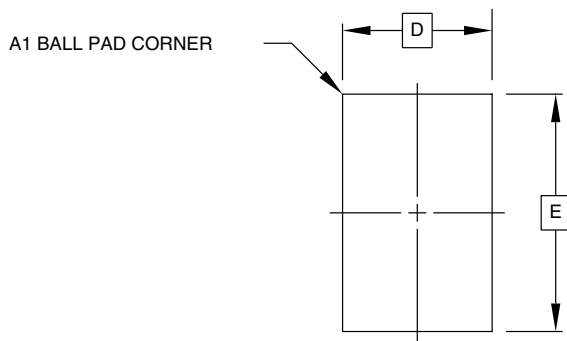

TOP VIEW

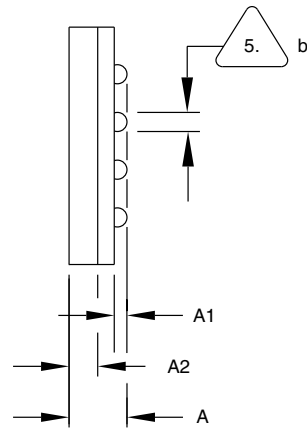

SIDE VIEW

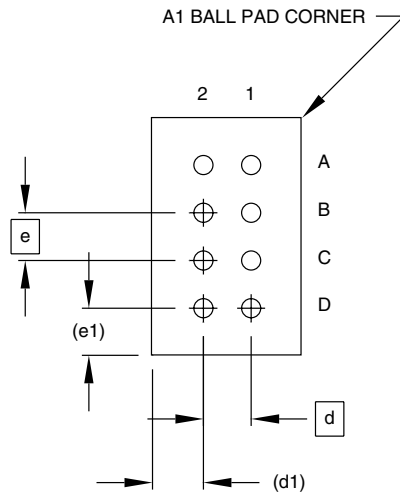

BOTTOM VIEW

8 SOLDER BALLS

COMMON DIMENSIONS
(Unit of Measure = mm)

SYMBOL	MIN	NOM	MAX	NOTE
A	0.81	0.91	1.00	
A1	0.15	0.20	0.25	
A2	0.40	0.45	0.50	
b	0.25	0.30	0.35	
D	2.47 BSC			
E	4.07 BSC			
e	0.75 BSC			
e1	0.74 REF			
d	0.75 BSC			
d1	0.80 REF			

5. Dimension 'b' is measured at the maximum solder ball diameter.

This drawing is for general information only.

1/5/05



1150 E. Cheyenne Mtn. Blvd.
Colorado Springs, CO 80906

TITLE

8U4-1, 8-ball, 2.47 x 4.07 mm Body, 0.75 mm pitch,
Small Die Ball Grid Array Package (dBGA2)

DRAWING NO.

PO8U4-1

REV.

A

8Y7 – SAP

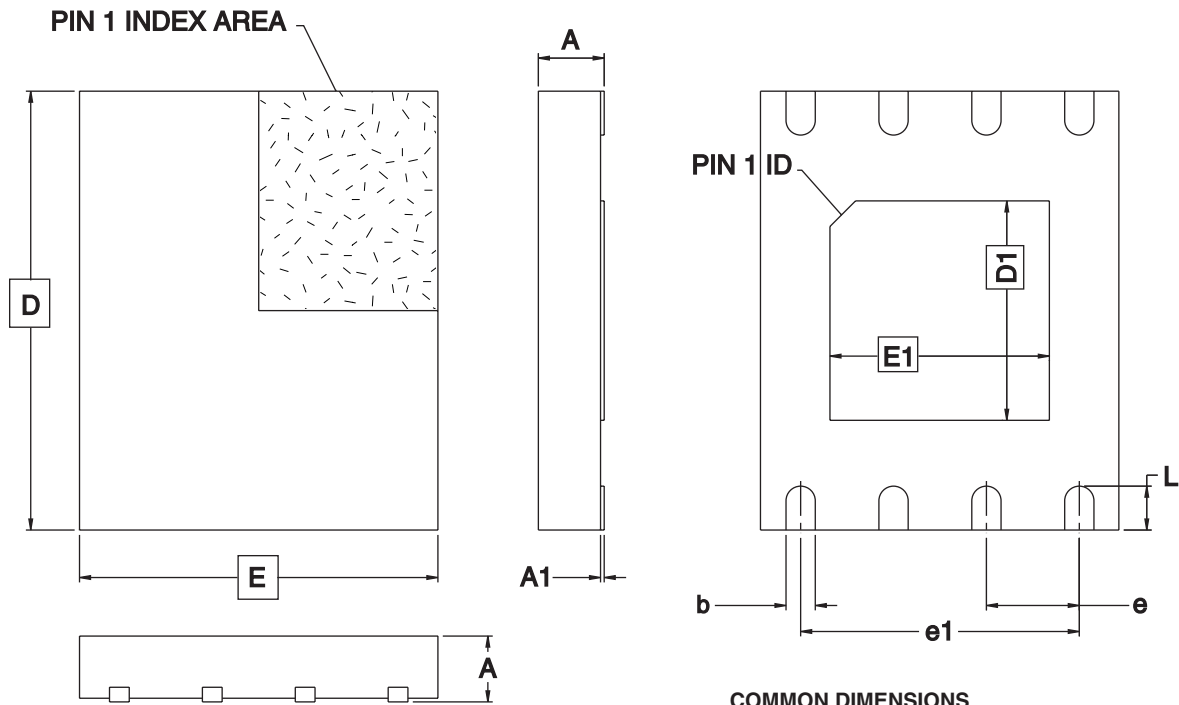

COMMON DIMENSIONS
(Unit of Measure = mm)

SYMBOL	MIN	NOM	MAX	NOTE
A	–	–	0.60	
A1	0.00	–	0.05	
D	5.80	6.00	6.20	
E	4.70	4.90	5.10	
D1	3.30	3.40	3.50	
E1	3.90	4.00	4.10	
b	0.35	0.40	0.45	
e	1.27 TYP			
e1	3.81 REF			
L	0.50	0.60	0.70	

10/13/05



1150 E. Cheyenne Mtn. Blvd.
Colorado Springs, CO 80906

TITLE

8Y7, 8-lead (6.00 x 4.90 mm Body) Ultra-Thin SOIC Array
Package (UTSAP) Y7

DRAWING NO.

8Y7

REV.

B



10. Revision History

Doc. No.	Date	Comments
5194E	8/2007	Updated Part Marking Scheme Updated to new Template Updated to common figures Added Package Marking tables
5194D	5/2007	Changed 'Advance Information' to 'Preliminary'
5194C	4/2007	Reduced Pin Configuration sizes Changed Maximum Operating Voltage from 6.0 to 6.25 Removed Device Power Up & Power Down Recommendation Added A2 bit to Device Addressing Removed LSB from Figure 10 Current Address Read Removed reference to Waffle Pack Modified Ordering Code table lines Global change on Voltage from 3.6 to 5.5, Correct pg 1 drawings to include address inputs
5194B	2/2007	Correct pg 1 TSSOP drawing
5194A	1/2007	Initial Document Release



Headquarters

Atmel Corporation
2325 Orchard Parkway
San Jose, CA 95131
USA
Tel: 1(408) 441-0311
Fax: 1(408) 487-2600

International

Atmel Asia
Room 1219
Chinachem Golden Plaza
77 Mody Road Tsimshatsui
East Kowloon
Hong Kong
Tel: (852) 2721-9778
Fax: (852) 2722-1369

Atmel Europe
Le Krebs
8, Rue Jean-Pierre Timbaud
BP 309
78054 Saint-Quentin-en-
Yvelines Cedex
France
Tel: (33) 1-30-60-70-00
Fax: (33) 1-30-60-71-11

Atmel Japan
9F, Tonetsu Shinkawa Bldg.
1-24-8 Shinkawa
Chuo-ku, Tokyo 104-0033
Japan
Tel: (81) 3-3523-3551
Fax: (81) 3-3523-7581

Product Contact

Web Site
www.atmel.com

Technical Support
s_eeeprom@atmel.com

Sales Contact
www.atmel.com/contacts

Literature Requests
www.atmel.com/literature

Disclaimer: The information in this document is provided in connection with Atmel products. No license, express or implied, by estoppel or otherwise, to any intellectual property right is granted by this document or in connection with the sale of Atmel products. **EXCEPT AS SET FORTH IN ATMEL'S TERMS AND CONDITIONS OF SALE LOCATED ON ATMEL'S WEB SITE, ATMEL ASSUMES NO LIABILITY WHATSOEVER AND DISCLAIMS ANY EXPRESS, IMPLIED OR STATUTORY WARRANTY RELATING TO ITS PRODUCTS INCLUDING, BUT NOT LIMITED TO, THE IMPLIED WARRANTY OF MERCHANTABILITY, FITNESS FOR A PARTICULAR PURPOSE, OR NON-INFRINGEMENT. IN NO EVENT SHALL ATMEL BE LIABLE FOR ANY DIRECT, INDIRECT, CONSEQUENTIAL, PUNITIVE, SPECIAL OR INCIDENTAL DAMAGES (INCLUDING, WITHOUT LIMITATION, DAMAGES FOR LOSS OF PROFITS, BUSINESS INTERRUPTION, OR LOSS OF INFORMATION) ARISING OUT OF THE USE OR INABILITY TO USE THIS DOCUMENT, EVEN IF ATMEL HAS BEEN ADVISED OF THE POSSIBILITY OF SUCH DAMAGES.** Atmel makes no representations or warranties with respect to the accuracy or completeness of the contents of this document and reserves the right to make changes to specifications and product descriptions at any time without notice. Atmel does not make any commitment to update the information contained herein. Unless specifically provided otherwise, Atmel products are not suitable for, and shall not be used in, automotive applications. Atmel's products are not intended, authorized, or warranted for use as components in applications intended to support or sustain life.

©2007 Atmel Corporation. All rights reserved. Atmel[®], logo and combinations thereof, are registered trademarks or trademarks of Atmel Corporation or its subsidiaries. Other terms and product names may be trademarks of others.