

# HEDS-970x, HEDS-972x Series

## Digital Output Small Optical Encoder Modules

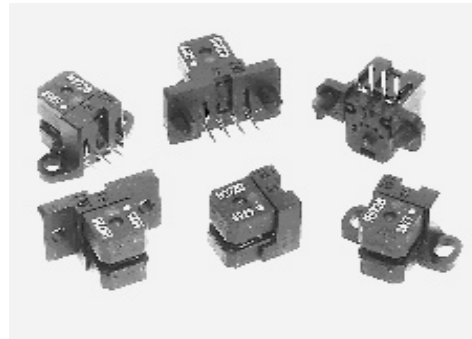

### Data Sheet



#### Description

The HEDS-9700 series is a high performance, low cost, optical incremental encoder module. When operated in conjunction with either a codewheel or codestrip, this module detects rotary or linear position. The module consists of a lensed LED source and a detector IC enclosed in a small C-shaped plastic package. Due to a highly collimated light source and a unique photo-detector array, the module is extremely tolerant to mounting misalignment.

The two channel digital outputs and 5V supply input are accessed through four solder-plated leads located on 2.54 mm (0.1 inch) centers.

The standard HEDS-9700 is designed for use with an 11 mm optical radius codewheel, or linear codestrip. Other options are available. Please contact factory for more information.

#### Features

- Small Size
- Low Cost
- Multiple Mounting Options
- Wide Resolution Range
- Linear and Rotary Options Available
- No Signal Adjustment Required
- Insensitive to Radial and Axial Play
- -40°C to +85°C Operating Temperature
- Two Channel Quadrature Output
- TTL Compatible
- Single 5V Supply
- Wave Solderable

#### Package Dimensions

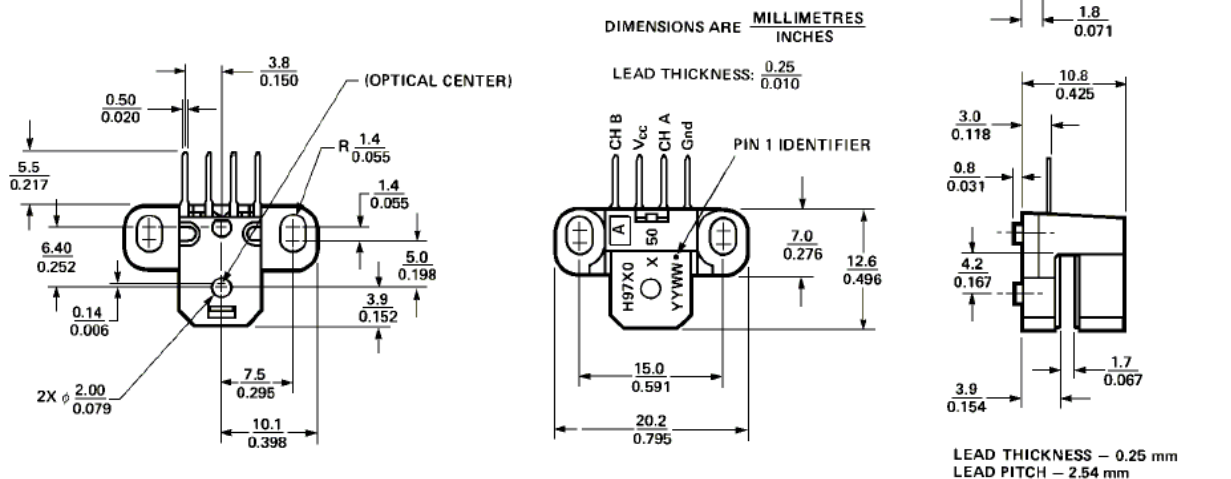

Mounting Option #50 - Standard (Baseplane Mounting) Contact Factory for Detailed Package Dimensions

ESD WARNING; NORMAL HANDLING PRECAUTIONS SHOULD BE TAKEN TO AVOID STATIC DISCHARGE.

## Applications

The HEDS-9700 provides sophisticated motion detection at a low cost, making closed-loop control very cost-competitive! Typical applications include printers, plotters, copiers, and office automation equipment.

**Note:** Avago Technologies encoders are not recommended for use in safety critical applications. Eg. ABS braking systems, power steering, life support systems and critical care medical equipment. Please contact sales representative if more clarification is needed.

## Block Diagram

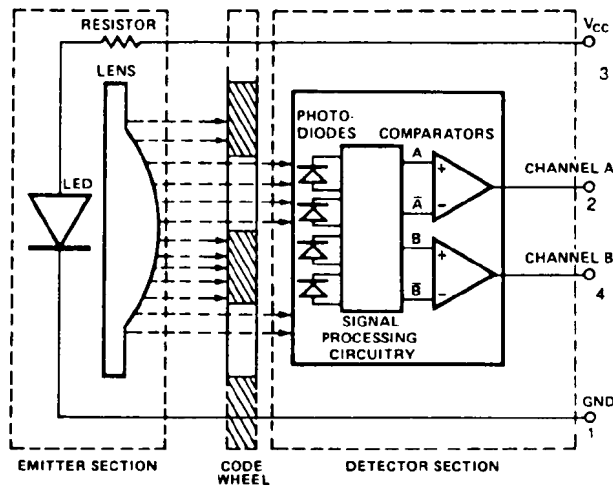

## Theory of Operation

The HEDS-9700 is a C-shaped emitter/detector module. Coupled with a codewheel, it translates rotary motion into a two-channel digital output. Coupled with a codestrip, it translates linear motion into a digital output.

As seen in the block diagram, the module contains a single Light Emitting Diode (LED) as its light source. The light is collimated into a parallel beam by means of a single lens located directly over the LED. Opposite the emitter is the integrated detector circuit. This IC consists of multiple sets of photodetectors and the signal processing circuitry necessary to produce the digital waveforms.

The codewheel/codestrip moves between the emitter and detector, causing the light beam to be interrupted by the pattern of spaces and bars on the codewheel/codestrip. The photodiodes which detect these interruptions are arranged in a pattern that corresponds to the radius and count density of the codewheel/codestrip. These detectors are also spaced such that a light period on one pair of detectors corresponds to a dark period on the adjacent pair of detectors. The photodiode outputs are fed through the signal processing circuitry. Two comparators receive these signals and produce the final outputs for channels A and B. Due to this integrated phasing technique, the digital output of channel A is in quadrature with channel B (90 degrees out of phase).

## Output Waveforms

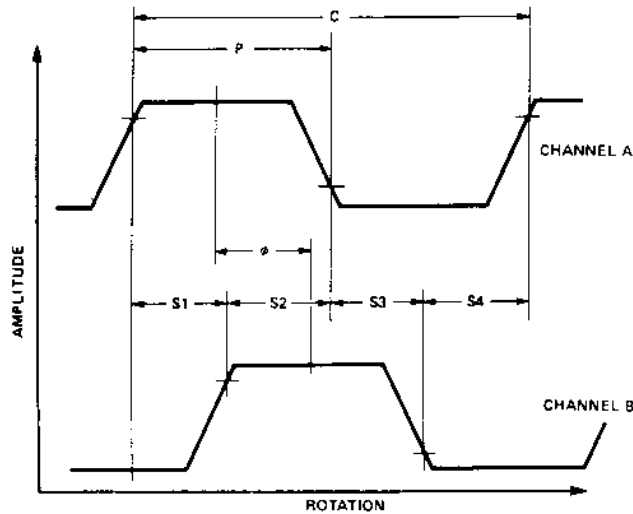

### Definitions

Count (N) = The number of bar and window pairs or counts per revolution (CPR) of the codewheel, or the number of lines per inch of the codestrip (LPI).

- 1 Shaft Rotation = 360  
mechanical  
degrees  
= N cycles
- 1 cycle (c) = 360 electrical  
degrees (°e)  
= 1 bar and  
window pair

Pulse Width (P): The number of electrical degrees that an output is high during one cycle. This value is nominally 180°e or 1/2 cycle.

Pulse Width Error ( $\Delta P$ ): The deviation, in electrical degrees, of the pulse width from its ideal value of 180°e.

State Width (S): The number of electrical degrees between a transition in the output of channel A and the neighboring transition in the output of channel B. There are 4 states per cycle, each nominally 90°e.

State Width Error ( $\Delta S$ ): The deviation, in electrical degrees, of each state width from its ideal value of 90°e.

Phase ( $\phi$ ): The number of electrical degrees between the center of the high state of channel A and the center of the high state of channel B. This value is nominally 90°e for quadrature output.

Phase Error ( $\Delta\phi$ ): The deviation of the phase from its ideal value of 90°e.

Direction of Rotation: When the codewheel rotates counterclockwise, as viewed looking down on the module (so the marking is visible), channel A will lead channel B. If the codewheel rotates in the opposite direction, channel B will lead channel A.

Optical Radius (Rop): The distance from the codewheel's center of rotation to the optical center (O.C.) of the encoder module.

### Absolute Maximum Ratings

Parameter	Symbol	Min.	Max.	Units	Notes
Storage Temperature	$T_s$	-40	85	°C	See Note
Operating Temperature	$T_A$	-40	85	°C	See Note
Supply Voltage	$V_{CC}$	-0.5	7	V	
Output Voltage	$V_O$	-0.5	$V_{CC}$	V	
Output Current per Channel	$I_O$	-1.0	5	mA	
Soldering Temperature			260	°C	t ≤ 5 sec.

## Recommended Operating Conditions

Parameter	Symbol	Min.	Max.	Units	Notes
Temperature	T	-40	85	°C	
Supply Voltage	V <sub>CC</sub>	4.5	5.5	V	Ripple < 100 mV <sub>p-p</sub>
Load Capacitance	C <sub>L</sub>		100	pF	3.2 kΩ pull-up
Count Frequency			20	kHz	(Velocity (rpm) x N)/60

**Note:** The module performance is guaranteed to 20 kHz but can operate at higher frequencies. For operation at 30kHz for resolution options E, F, G and H, the maximum pulse width and logic state width errors are 40°e and phase error is 15°e.

## Encoding Characteristics

Encoding Characteristics over Recommended Operating Range and Recommended Mounting Tolerances. These characteristics do not include codewheel/codestrip contributions.

Parameter	Symbol	Typ.	Case 1	Case 2	Units	Notes
			Max.	Max.		
Pulse Width Error	ΔP	7	30	40	°e	
Logic State Width Error	ΔS	5	30	40	°e	
Phase Error	Δφ	2	10	15	°e	

Case 1: Module mounted on tolerances of ±0.13 mm (0.005"). Case 2: Module mounted on tolerances of ±0.25 mm (0.010")

**Note:** See Figures in Mounting Considerations for details on Case 1 and Case 2 mounting tolerances.

## Electrical Characteristics

Electrical Characteristics over Recommended Operating Range, Typical at 25°C.

Parameter	Symbol	Min.	Typ.	Max.	Units	Notes
Supply Current	I <sub>CC</sub>		17	40	mA	
High Level Output Voltage	V <sub>OH</sub>	2.4			V	I <sub>OH</sub> = -40 μA
Low Level Output Voltage	V <sub>OL</sub>			0.4	V	I <sub>OL</sub> = 3.2 mA
Rise Time	t <sub>r</sub>		200		ns	C <sub>L</sub> = 25 pF, R <sub>L</sub> = 11 kΩ
Fall Time	t <sub>f</sub>		50		ns	C <sub>L</sub> = 25 pF, R <sub>L</sub> = 11 kΩ

## Recommended Codewheel and Codestrip Characteristics

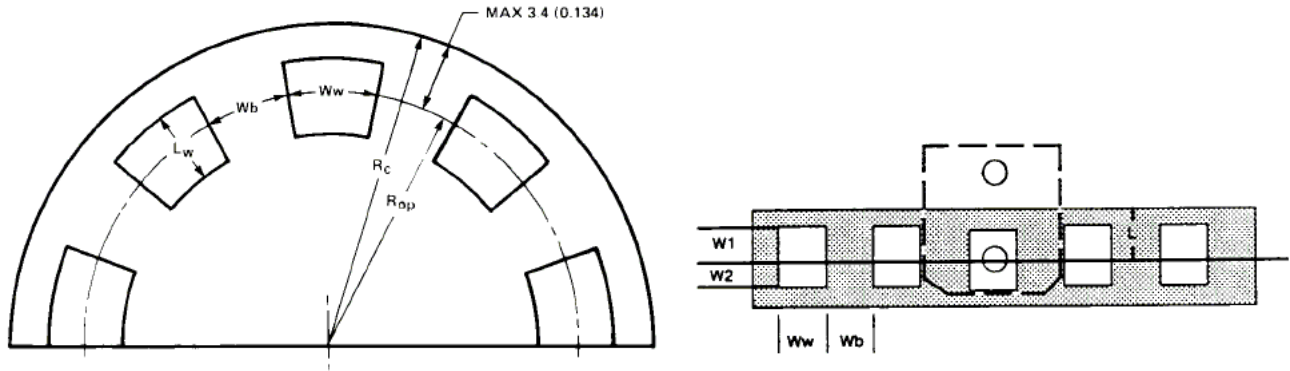

Parameter	Symbol	Min.	Max.	Units	Notes
Window/Bar Ratio	Ww/Wb	0.7	1.4		
Window Length (Rotary)	Lw	1.80 (0.071)	2.30 (0.091)	mm (inch)	
Absolute Maximum Codewheel Radius (Rotary)	Rc		Rop + 3.40 (Rop + 0.134)	mm (inch)	Includes eccentricity errors
Center of Post to Inside Edge of Window	W1	1.04 (0.041)		mm (inch)	
Center of Post to Outside Edge of Window	W2	0.76 (0.030)		mm (inch)	
Center of Post to Inside Edge of Codestrip	L		3.60 (0.142)	mm (inch)	

## Optional Packages Available

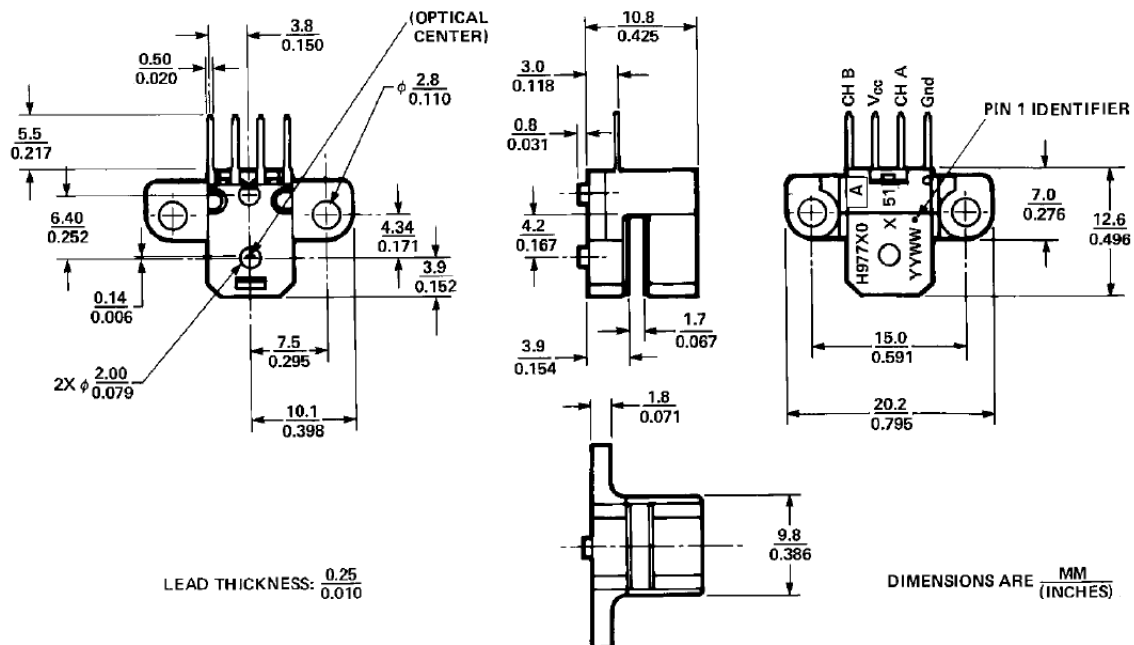

Mounting Option #51 – Rounded Outline (Baseplane Mounting)

**Optional Packages Available (cont'd.)**

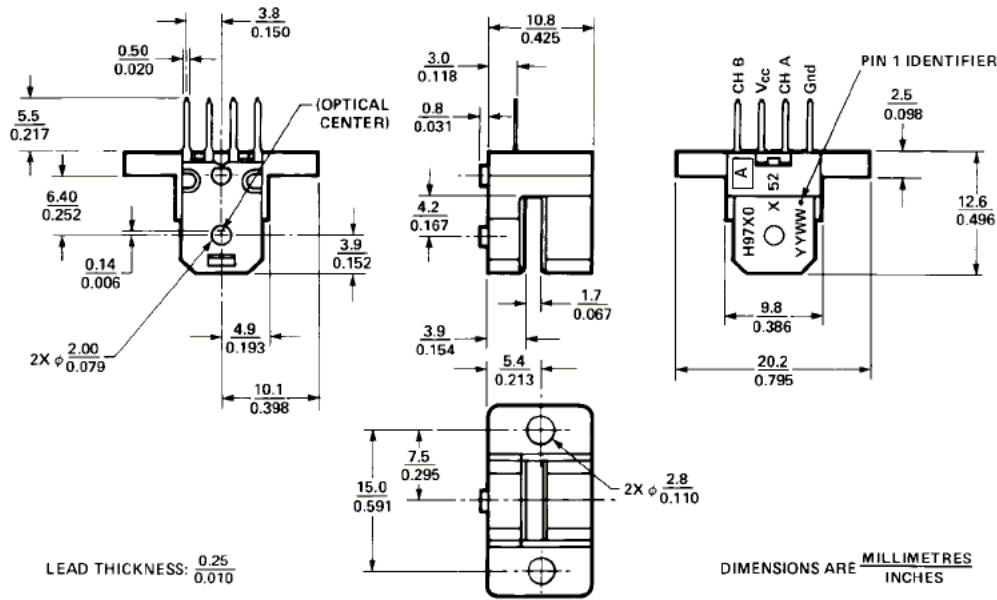

**Mounting Option #52 – Backplane (Backplane Mounting)**

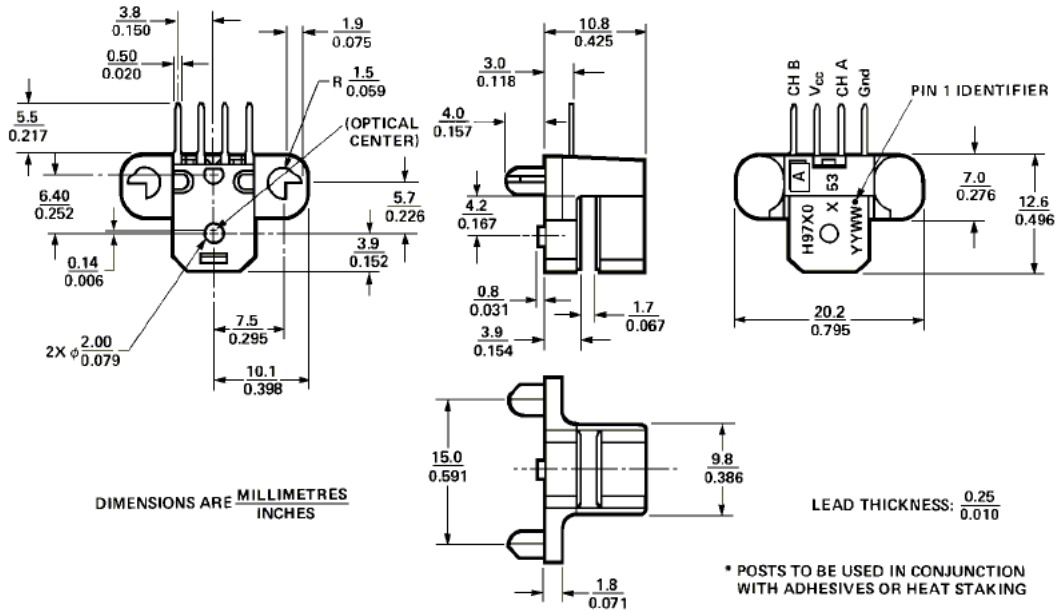

**Mounting Option #53 – Standard with Posts (Baseplane Mounting)**

Optional Packages Available (cont'd.)

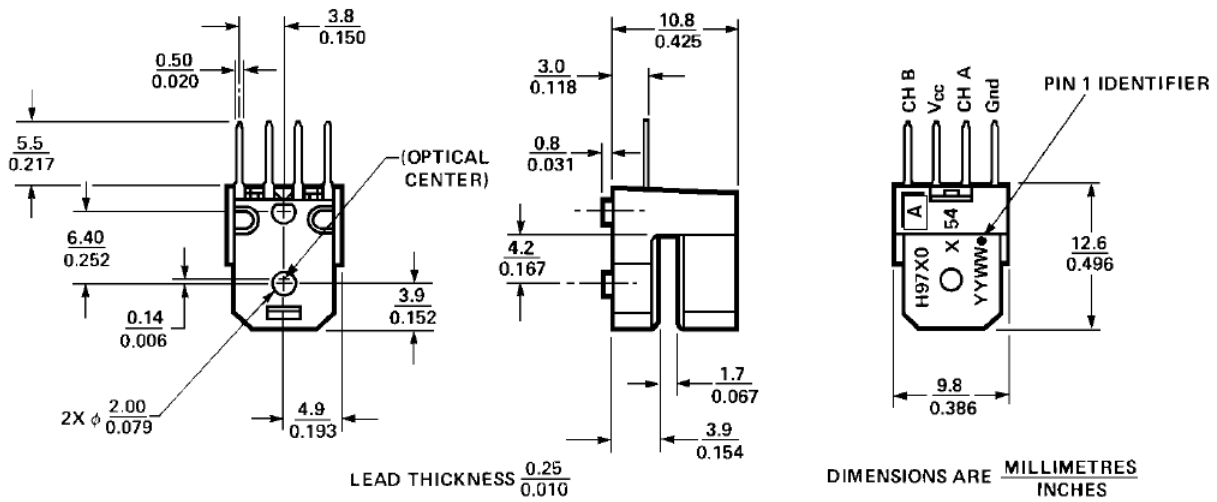

Mounting Option #54 – Tabless (Baseplane Mounting)

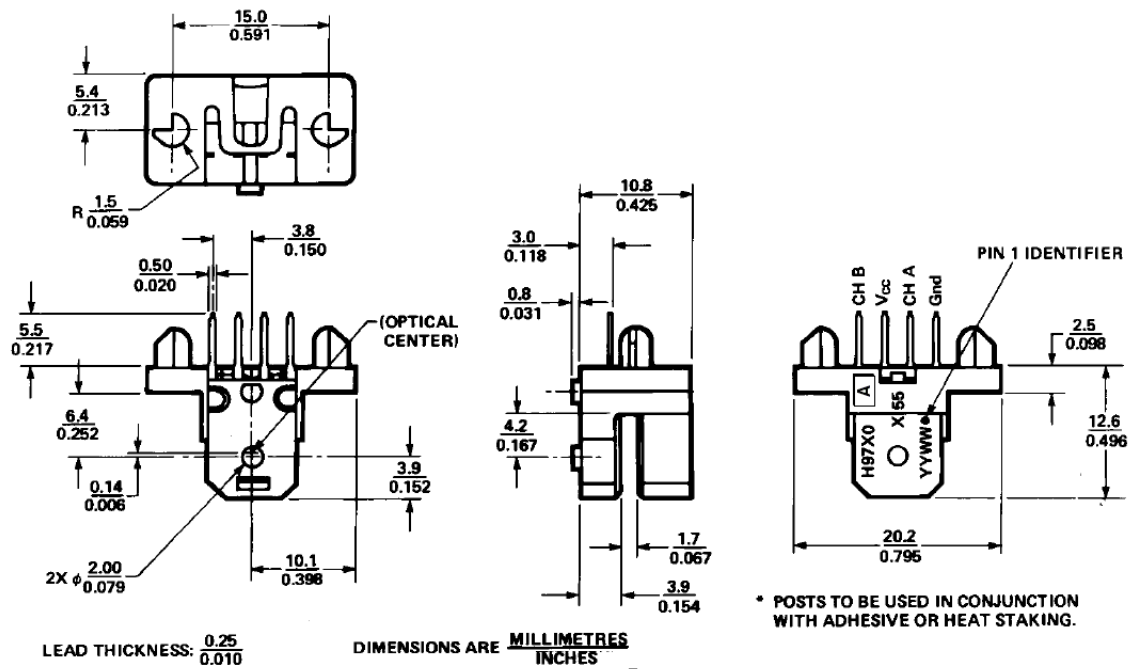

Mounting Option #55 – Backplane with Posts (Backplane Mounting)

## Bent Lead Option

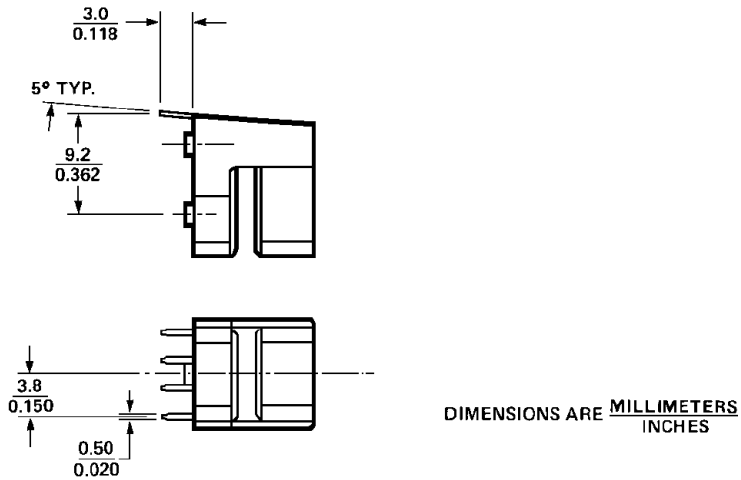

## Mounting Considerations

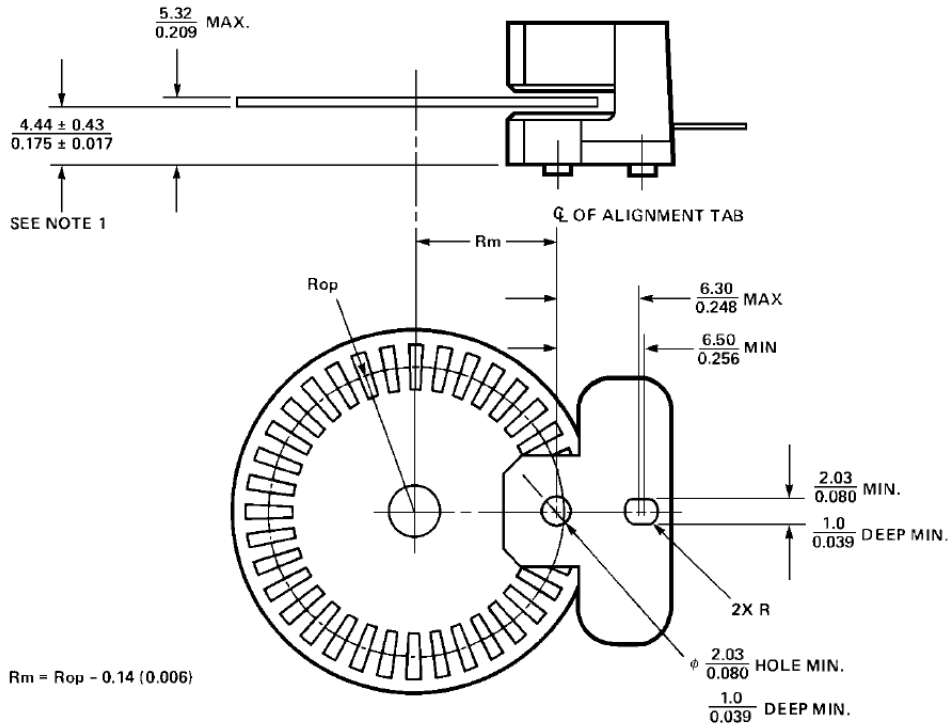

**Note:** These dimensions include shaft end play and codewheel warp.

All dimensions for mounting the module and codewheel/codestrip should be measured with respect to the two mounting posts, shown above.

## Mounting Tolerances

Case 1 and Case 2 specify the mounting tolerances required on Rm in order to achieve the respective encoding characteristics shown on page 4. The mounting tolerances are as follows:

- Case 1:  $R_m \pm 0.13$  mm (.005 inches)
- Case 2:  $R_m \pm 0.25$  mm (.010 inches)

**Recommended Screw Size:** M2.5 x 0.45 or 2-56



## Recommended Wave Solder Conditions

Flux – RMA Water Soluble (per MIL-F-14256D)

### Process Parameters

1. Flux
2. Pre-heat 60 seconds total  
Nominal preheat temp: 90°C  
Min: 85°C Max: 110°C
3. Solder Pot Zone  
Nominal dip in time:  
2.5 - 4.5 seconds  
Min: 2.5 seconds  
Max: 5 seconds  
PCB top side: 140 -160°C  
PCB bottom side: 240 - 260°C
4. Wave Solder 255°C,  
1.2 meters/minute line speed
5. Hot Water Wash  
1st: 30°C 45 seconds  
2nd: 70°C 90 seconds
6. Rinse  
1st: 23°C 45 seconds  
2nd: 23°C 45 seconds
7. Dry  
1st: 80°C 105 seconds  
2nd: 95°C 105 seconds

## Typical Interface

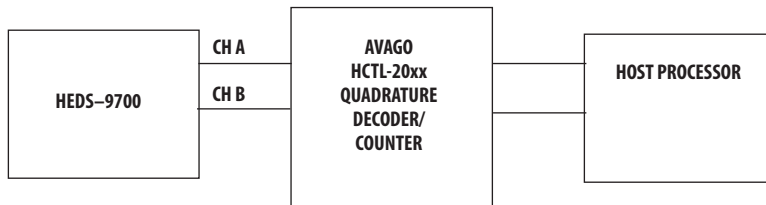

## Ordering Information

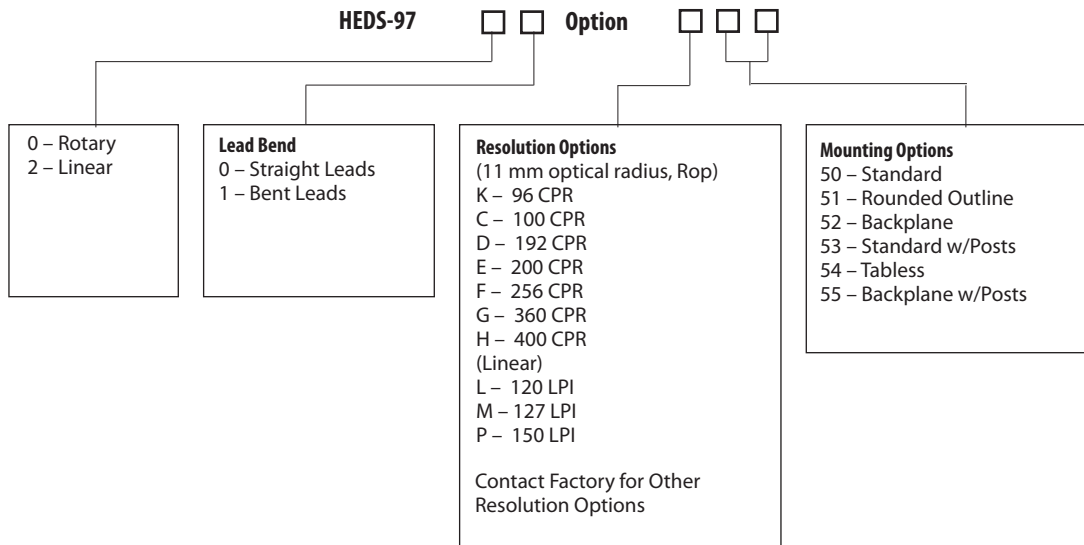

**Note:** Please contact factory for codewheel and codestrip information.

		50	51	52	53	54	55			50	51	52	53	54	55
HEDS-9700	K							HEDS-9720	K						
	C	*							C						
	D	*					*		D						
	E	*							E						
	F	*	*	*		*			F						
	G								G						
	H	*	*	*			*		H						
	L								L	*		*		*	
	M								M						
P							P	*	*	*		*	*		
HEDS-9701	K							HEDS-9721	K						
	C		*			*			C						
	D								D						
	E	*				*			E						
	F		*			*			F						
	G								G						
	H	*			*	*			H						
	L								L		*				
	M								M						
P							P	*	*		*				

For product information and a complete list of distributors, please go to our web site: [www.avagotech.com](http://www.avagotech.com)

Avago, Avago Technologies, and the A Logo are trademarks of Avago Technologies, Limited in the United States and other countries. Data subject to change. Copyright © 2006 Avago Technologies Limited. All rights reserved. Obsoletes 5988-8045EN AV02-0511EN - June 13, 2007

**AVAGO**  
TECHNOLOGIES