

Agilent HSMM/MN-C110, C170, C190, C191, and C150 SMT ChipLEDs Data Sheet

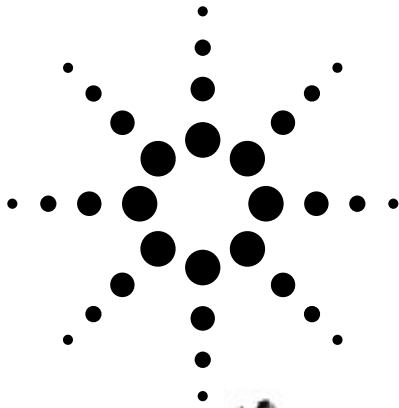

Description

These small chip-type LEDs utilize high efficient InGaN/SiC material to deliver competitively priced high performance blue and green. These 525 nm green and 470 nm blue are unique hues which provide color differentiation to a product.

These ChipLEDs come in either top emitting packages (HSMx-C170, C190, C191, and C150) or in a side emitting package (HSMx-C110). The side emitting package is especially suitable for LCD

backlighting application. The top emitting packages with their wide viewing angle are suitable for direct backlighting application or being used with light pipes. In order to facilitate pick and place operation, these ChipLEDs are shipped in tape and reel with 4000 units per reel for HSMx-C170, C190, and C191 packages, and 3000 units per reel for HSMx-C110 and C150 packages. All packages are compatible with IR soldering and binned by both color and intensity.

Features

- High brightness
- Small size
- Industrial standard footprint
- Diffused optics
- Top emitting or right angle emitting
- Compatible with IR soldering
- Compatible for use with light piping
- Available in 8 mm tape on 7" diameter reel
- Reel sealed in zip locked moisture barrier bags

Applications

- LCD backlighting
- Pushbutton backlighting
- Front panel indicator
- Symbol indicator
- Microdisplays
- Small message panel signage

Device Selection Guide

Package Dimension (mm) [1], [2]	Ingan Green	Ingan Blue	Package Description
1.6 (L) x 0.8 (W) x 0.6 (H)	HSMM-C191	HSMN-C191	Untinted, Diffused
1.6 (L) x 0.8 (W) x 0.8 (H)	HSMM-C190	HSMN-C190	Untinted, Diffused
2.0 (L) x 1.25 (W) x 0.8 (H)	HSMM-C170	HSMN-C170	Untinted, Diffused
3.2 (L) x 1.0 (W) x 1.5 (H)	HSMM-C110	HSMN-C110	Untinted, Nondiffused
3.2 (L) x 1.6 (W) x 1.1 (H)	HSMM-C150	HSMN-C150	Untinted, Diffused

Notes: 1. Dimensions in mm. 2. Tolerance ± 0.1 mm unless otherwise noted.

CAUTION: HSMM-C1xx and HSMN-C1xx are Class 1 ESD sensitive per MIL-STD-1686. Please observe appropriate precautions during handling and processing. Refer to Agilent Technologies Application Note AN-1142 for additional details.



Agilent Technologies

Package Dimensions

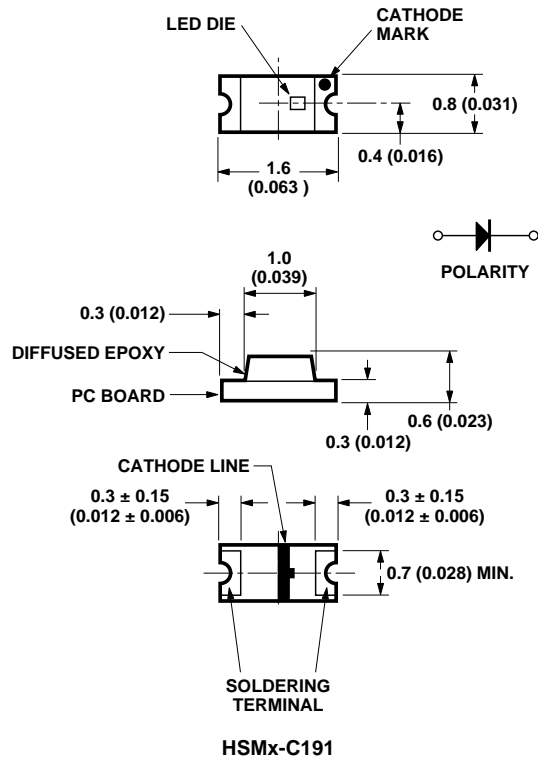
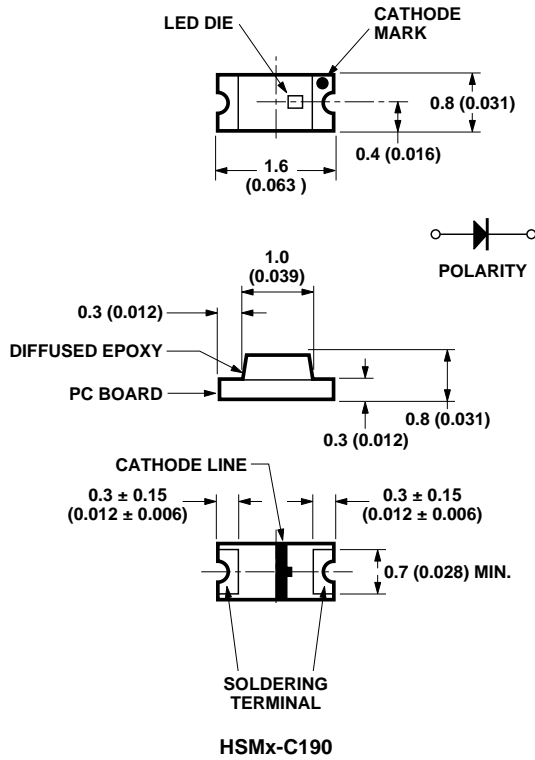
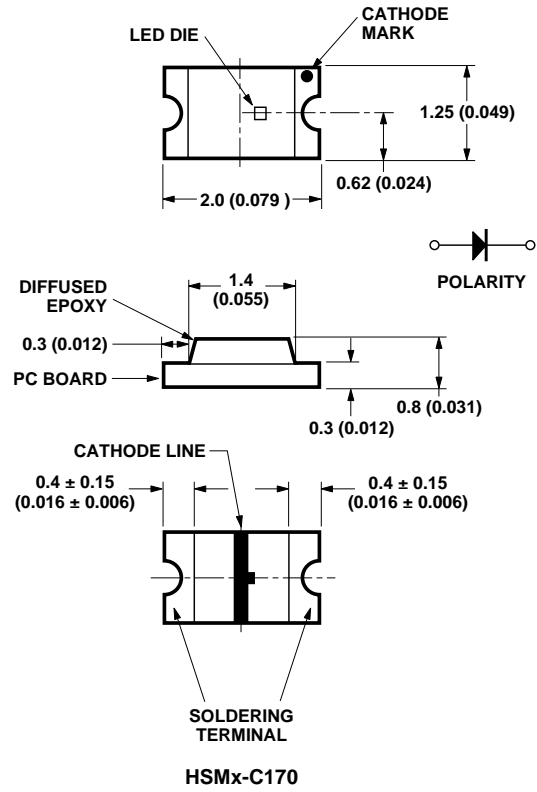
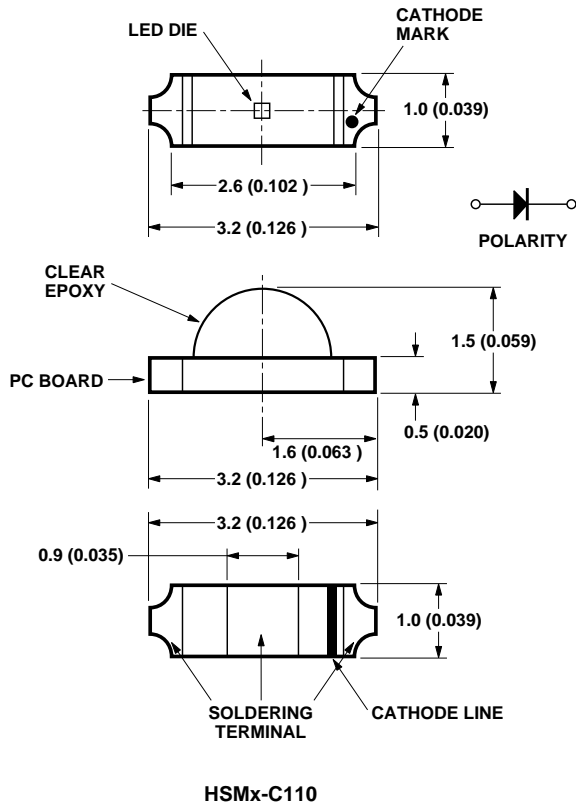

Package Dimensions, continued

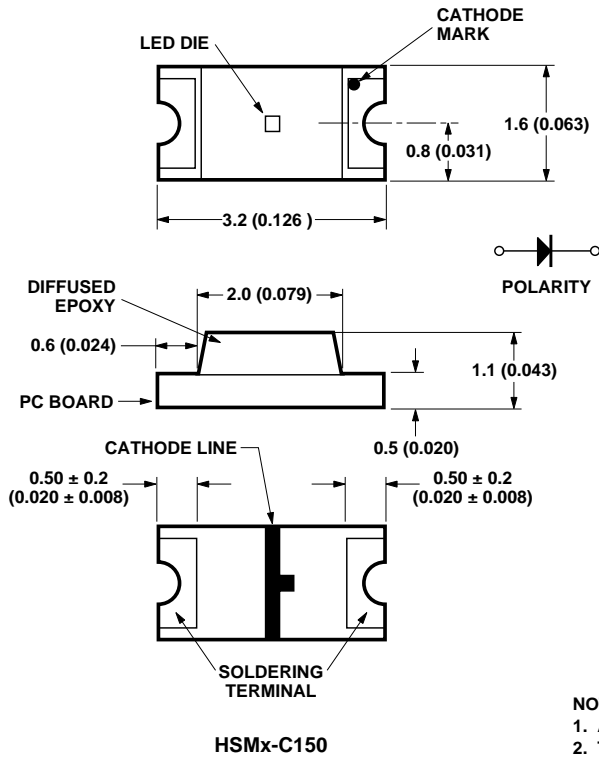

NOTES:

1. All dimensions in millimeters (inches).
2. Tolerance is ± 0.1 mm (± 0.004 in.) unless otherwise specified.

Absolute Maximum Ratings at $T_A = 25^\circ\text{C}$

Parameter	HSMM-C110/C170/C190/C191/C150 HSMN-C110/C170/C190/C191/C150	Units
DC Forward Current [1]	20	mA
Power Dissipation	78	mW
Reverse Voltage ($I_R = 100 \mu\text{A}$)	5	V
Led Junction Temperature	95	$^\circ\text{C}$
Operating Temperature Range	-30 to +85	$^\circ\text{C}$
Storage Temperature Range	-40 to +85	$^\circ\text{C}$
Soldering Temperature	See IR soldering profile (Figure 7)	

Note:

1. Derate linearly as shown in Figure 4.

Electrical Characteristics at $T_A = 25^\circ\text{C}$

Part Number	Forward Voltage V_F (Volts) @ $I_F = 20$ mA		Reverse Breakdown V_R (Volts) @ $I_R = 100 \mu\text{A}$	Capacitance C (pF), $V_F = 0$, $f = 1$ MHz	Thermal Resistance $R_{\theta J-PIN}$ ($^\circ\text{C}/\text{W}$)
	Typ.	Max.	Min.	Typ.	Typ.
HSMM-C110/C150	3.3	3.9	5	70	450
HSMN-C110/C150	3.3	3.9	5	70	450
HSMM-C170/C190/C191	3.3	3.9	5	70	300
HSMN-C170/C190/C191	3.3	3.9	5	70	300

V_F Tolerance: ± 0.1 V.

Optical Characteristics at T_A = 25°C

Part Number	Color	Luminous Intensity I _v (mcd) @ 20 mA ^[1]		Peak Wavelength λ _{peak} (nm) Typ.	Color, Dominant Wavelength λ _d ^[2] (nm) Typ.	Viewing Angle 2 θ _{1/2} Degrees ^[3] Typ.	Luminous Efficacy η _v (lm/w) Typ.
		Min.	Typ.				
HSMM-C110	Green	40	126	523	525	130	490
HSMM-C170/C190/C191/C150	Green	40	120	523	525	170	490
HSMN-C110	Blue	10	39	468	470	130	77
HSMN-C170/C190/C191/C150	Blue	10	35	468	470	170	77

Notes:

1. The luminous intensity, I_v, is measured at the peak of the spatial radiation pattern which may not be aligned with the mechanical axis of the lamp package.
2. The dominant wavelength, λ_d, is derived from the CIE Chromaticity Diagram and represents the perceived color of the device.
3. θ_{1/2} is the off-axis angle where the luminous intensity is 1/2 the peak intensity.

Color Bin Limits^[1]

Bin ID	Blue Color Bins ^[1]	
	Dom. Wavelength (nm)	
	Min.	Max.
A	460.0	465.0
B	465.0	470.0
C	470.0	475.0
D	475.0	480.0

Tolerance: ± 1 nm

Bin ID	InGaN Green Color Bins ^[1]	
	Dom. Wavelength (nm)	
	Min.	Max.
A	515.0	520.0
B	520.0	525.0
C	525.0	530.0
D	530.0	535.0

Tolerance: ± 1 nm

Note:

1. Bin categories are established for classification of products. Products may not be available in all categories. Please contact your Agilent representative for information on currently available bins.

Light Intensity (I_v) Bin Limits^[1]

Bin ID	Intensity (mcd)		Bin ID	Intensity (mcd)	
	Min.	Max.		Min.	Max.
A	0.11	0.18	N	28.50	45.00
B	0.18	0.29	P	45.00	71.50
C	0.29	0.45	Q	71.50	112.50
D	0.45	0.72	R	112.50	180.00
E	0.72	1.10	S	180.00	285.00
F	1.10	1.80	T	285.00	450.00
G	1.80	2.80	U	450.00	715.00
H	2.80	4.50	V	715.00	1125.00
J	4.50	7.20	W	1125.00	1800.00
K	7.20	11.20	X	1800.00	2850.00
L	11.20	18.00	Y	2850.00	4500.00
M	18.00	28.50			

Tolerance: ± 15%

Note:

1. Bin categories are established for classification of products. Products may not be available in all categories. Please contact your Agilent representative for information on currently available bins.

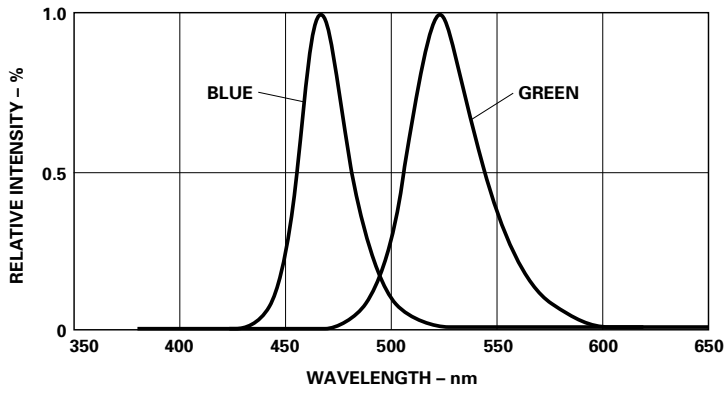

Figure 1. Relative intensity vs. wavelength.

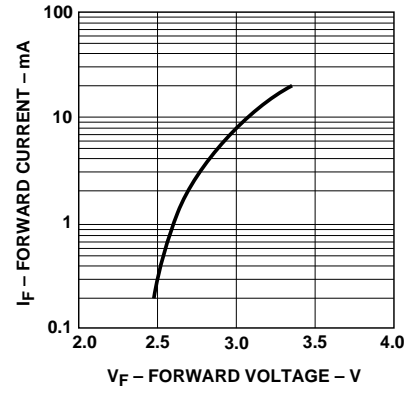

Figure 2. Forward current vs. forward voltage.

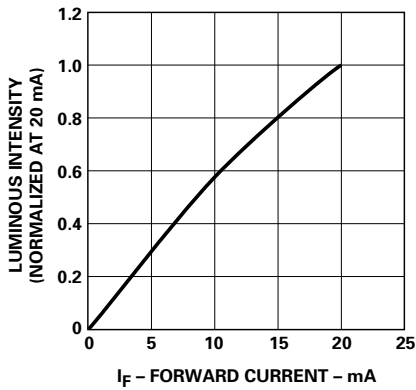

Figure 3. Luminous intensity vs. forward current.

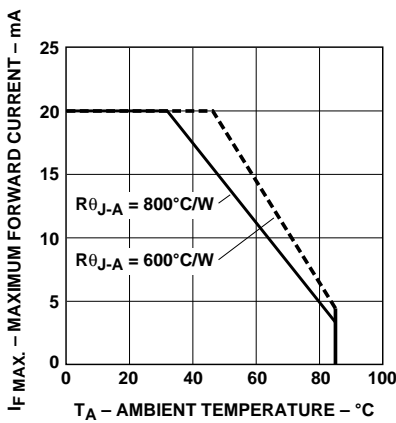

Figure 4. Maximum forward current vs. ambient temperature.

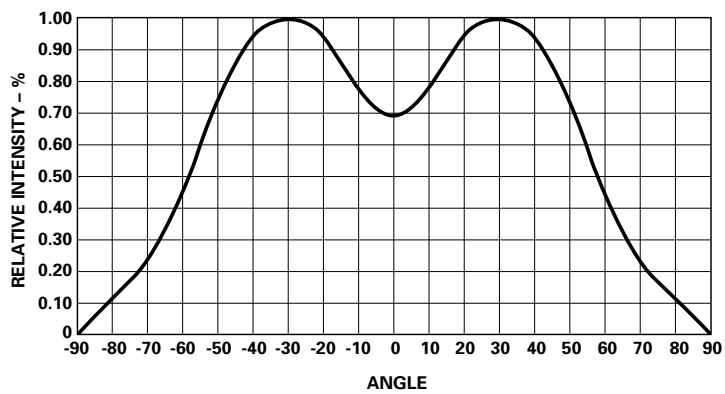
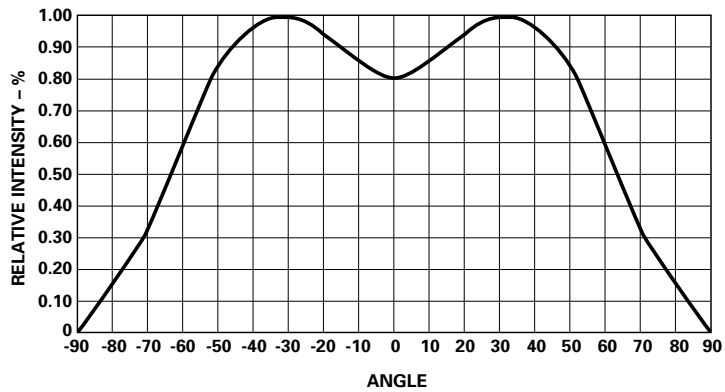

Figure 5. Relative intensity vs. angle for HSMx-C110.

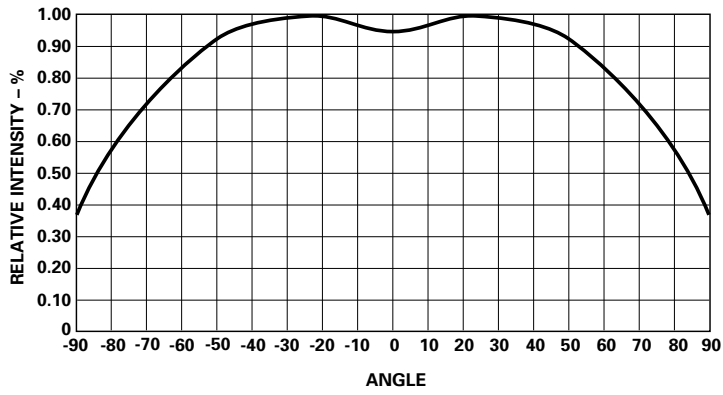

Figure 6. Relative intensity vs. angle for HSMx-C170, C190, C191, and C150.

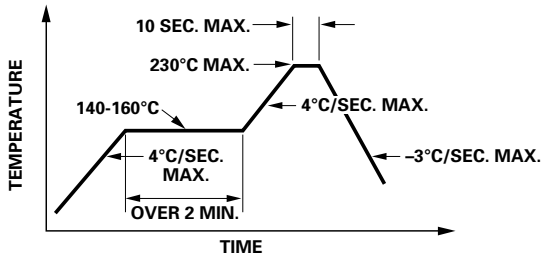

Figure 7. Recommended reflow soldering profile.

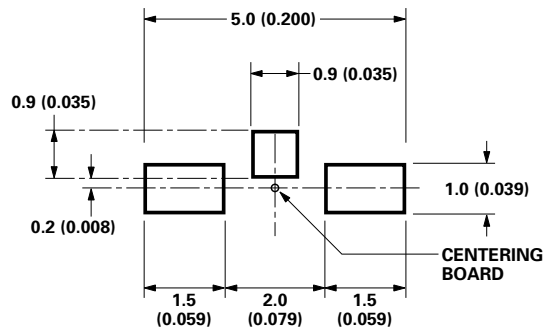

Figure 8. Recommended soldering pattern for HSMx-C110.

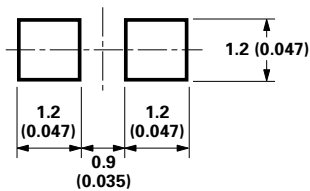

Figure 9. Recommended soldering pattern for HSMx-C170.

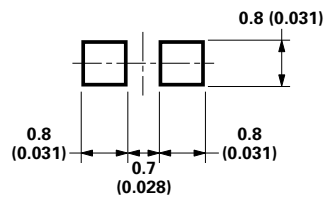

Figure 10. Recommended soldering pattern for HSMx-C190 and HSMx-C191.

NOTE:

1. All dimensions in millimeters (inches).

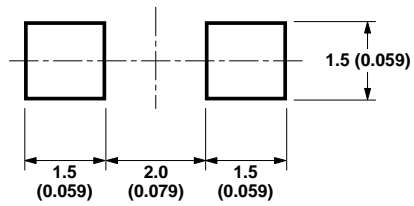

Figure 11. Recommended soldering pattern for HSMx-C150.

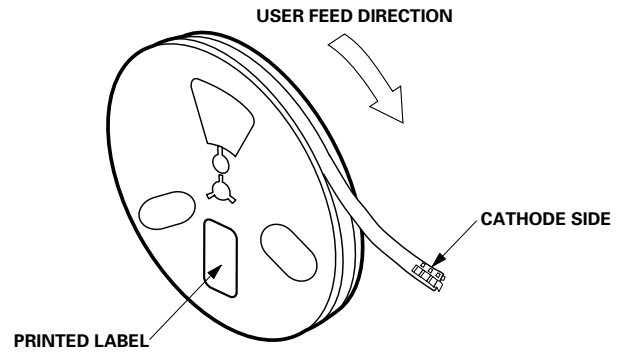

Figure 12. Reeling orientation.

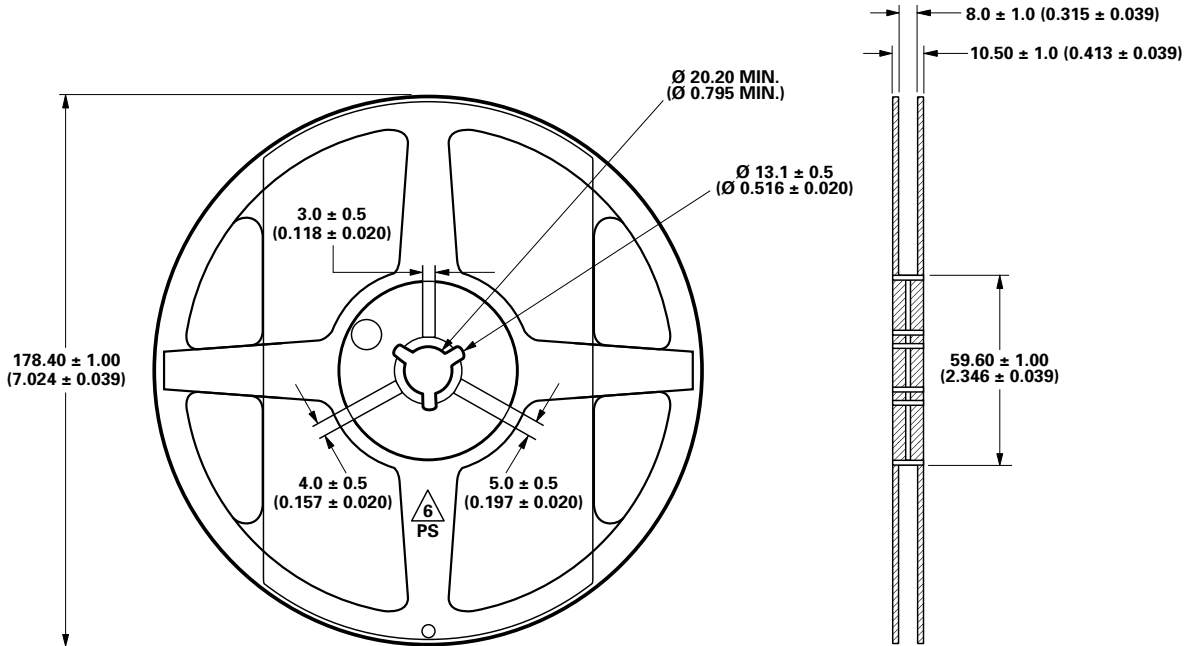

Figure 13. Reel dimensions.

NOTE:

1. All dimensions in millimeters (inches).

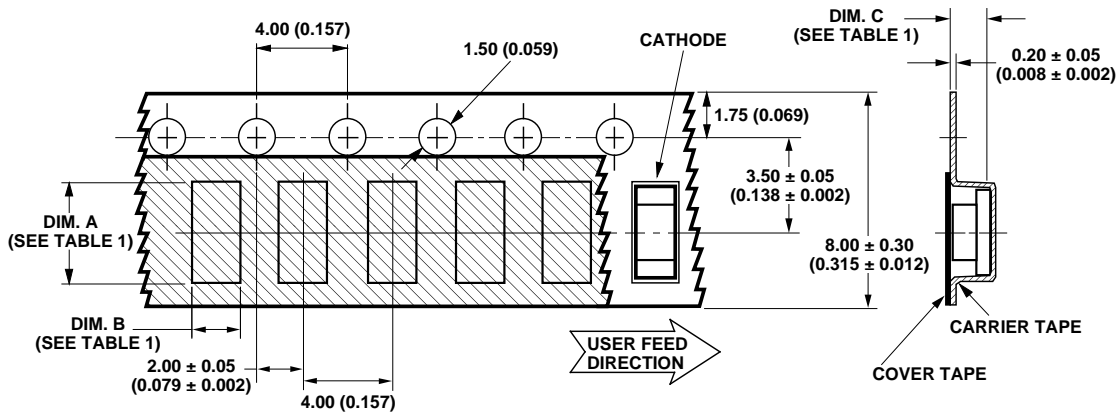

TABLE 1
DIMENSIONS IN MILLIMETERS (INCHES)

PART NUMBER	DIM. A ± 0.10 (± 0.004)	DIM. B ± 0.10 (± 0.004)	DIM. C ± 0.10 (± 0.004)
HSMx-C191 SERIES	1.80 (0.071)	0.95 (0.037)	0.75 (0.030)
HSMx-C190 SERIES	1.80 (0.071)	0.95 (0.037)	0.87 (0.034)
HSMx-C170 SERIES	2.40 (0.094)	1.60 (0.063)	1.20 (0.047)
HSMx-C110 SERIES	3.40 (0.134)	1.70 (0.067)	1.20 (0.047)
HSMx-C150 SERIES	3.75 (0.148)	2.10 (0.083)	1.30 (0.051)

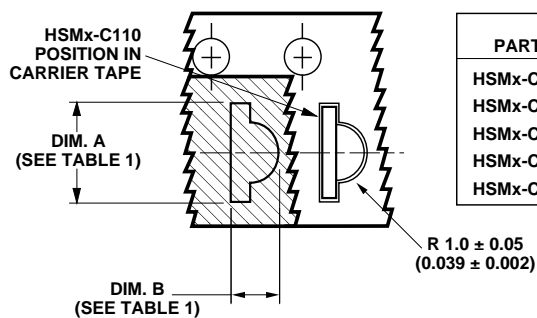

Figure 14. Tape dimensions.

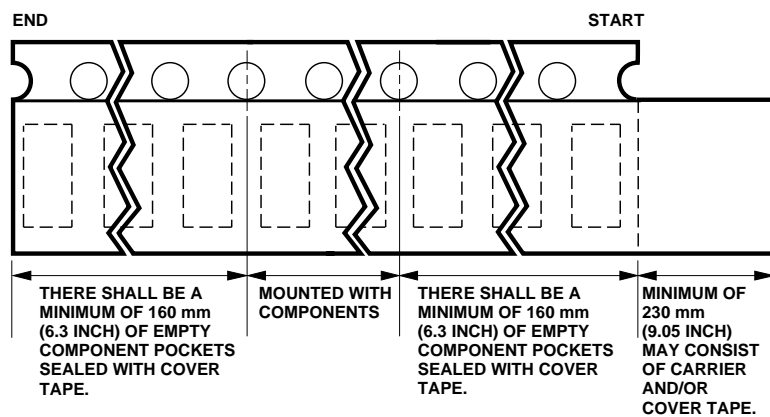

Figure 15. Tape leader and trailer dimensions.

NOTES:

1. All dimensions in millimeters (inches).
2. Tolerance is ± 0.1 mm (± 0.004 in.) unless otherwise specified.

Convective IR Reflow Soldering

For more information on IR reflow soldering, refer to Application Note 1060, *Surface Mounting SMT LED Indicator Components*.

Storage Condition: 5 to 30°C @ 60% RH max.

Baking is required under the condition:

- a) the blue silica gel indicator becoming white/transparent color
- b) the pack has been opened for more than 1 week

Baking recommended condition: 60 +/- 5°C for 20 hours.

For product information and a complete list of Agilent contacts and distributors, please go to our web site.

www.agilent.com/semiconductors

E-mail: SemiconductorSupport@agilent.com

Data subject to change.

Copyright © 2002 Agilent Technologies, Inc.

Obsoletes 5988-4471EN

March 11, 2002

5988-5213EN



Agilent Technologies