

HSMW-Cxxx

White ChipLEDs



Data Sheet

**HSMW-C191, HSMW-130, HSMW-265,
HSMW-197, HSMW-120**

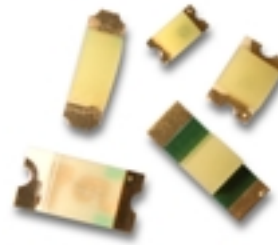

Description

These white ChipLEDs come in unique shades of white and provide product differentiation for backlighting application. They are designed in industry standard package for ease of handling and use.

These chipLEDs come in either top emitting packages (HSMW-C191, 130, 265, & 197) or in a side emitting package (HSMW-C120).

The packages all compatible with IR reflow soldering process and come in 8 mm tape on 7" diameter reel. They are compatible with automatic placement equipment.

In order to facilitate pick and place operation, these chipLEDs are shipped in tape and reel with 4000 units per reel for HSMW-C191, 130, 197, and 120 packages, and 3000 units per reel for HSMW-C265 package.

Features

- **White color**
- **Small size**
- **Industry standard footprint**
- **Compatible with reflow soldering**
- **Compatible with automatic placement equipment**
- **Operating temperature range -30°C to $+85^{\circ}\text{C}$**
- **Come in 8 mm tape on 7" diameter reels**

Applications

- **LCD backlighting**
- **Keypad backlighting**
- **Pushbutton backlighting**
- **Symbol backlighting**

CAUTION: HSMW-Cxxx LEDs are Class 1A ESD sensitive per JESD22-A114C.01. Please observe appropriate precautions during handling and processing. Refer to Avago Technologies Application Note AN-1142 for additional details.

Package Dimensions

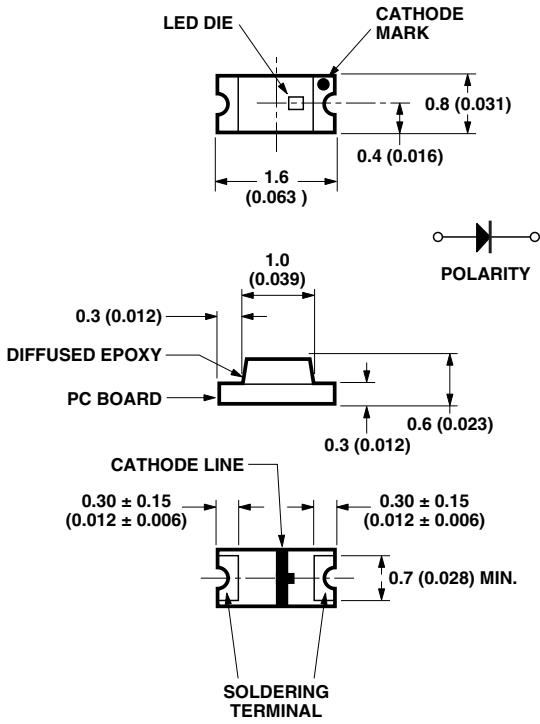

HSMW-C191

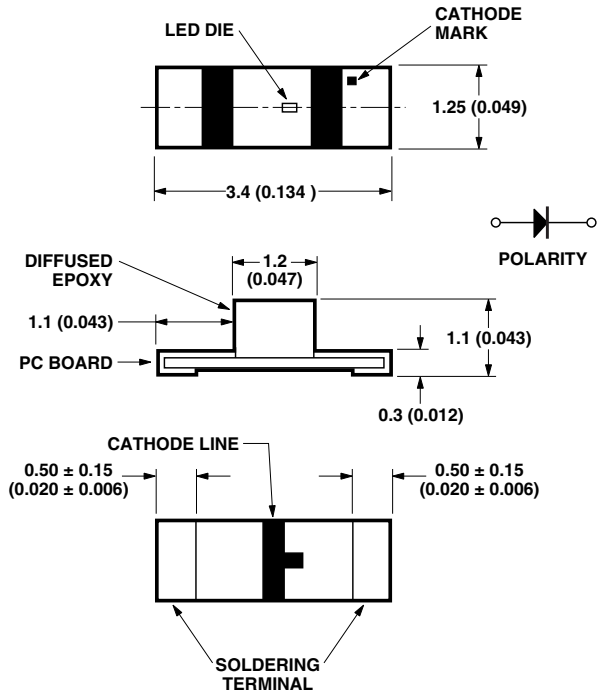

HSMW-C265

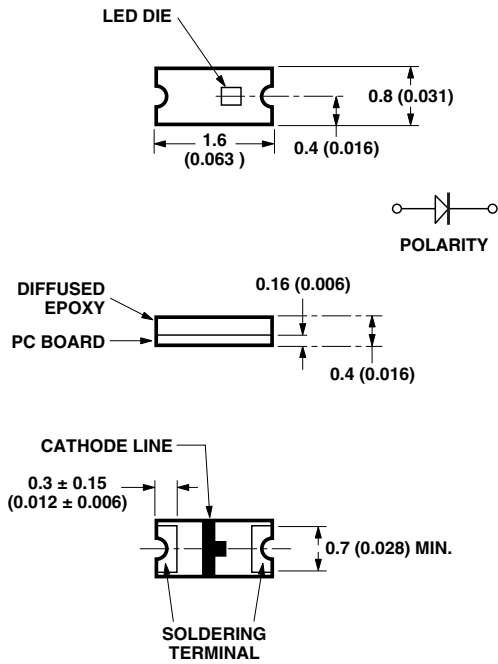

HSMW-C197

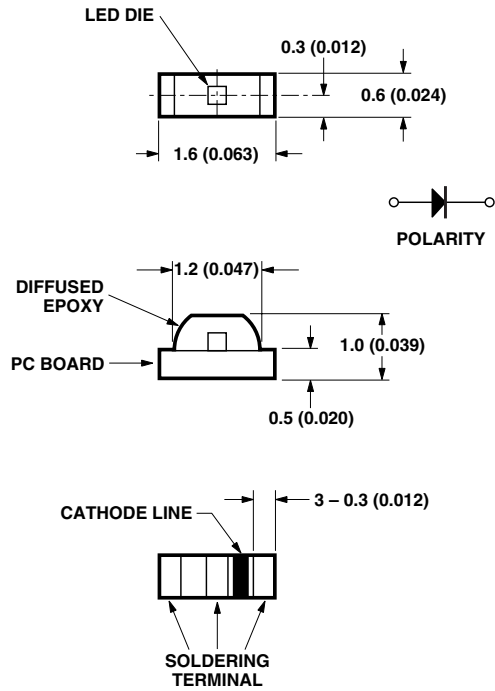

HSMW-C120

- NOTES:
 1. DIMENSIONS ARE IN MILLIMETERS (INCHES).
 2. TOLERANCE ±0.1 mm UNLESS OTHERWISE NOTED.

Package Dimensions, continued

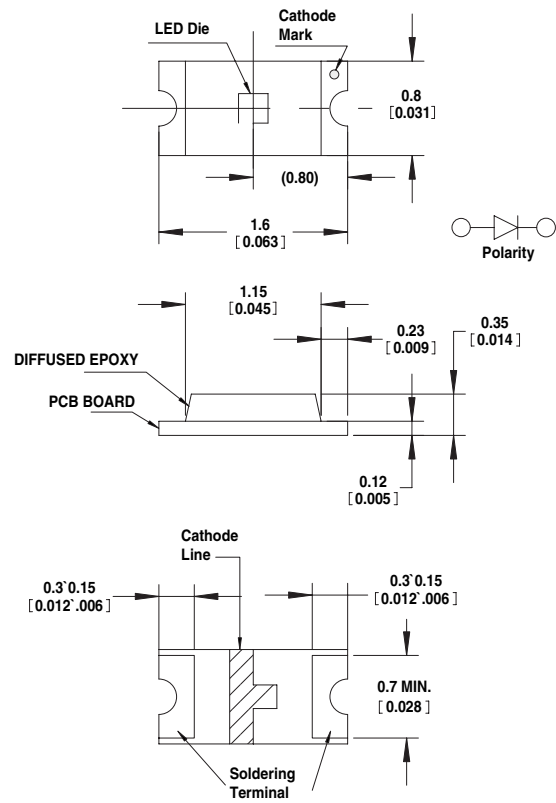

HSMW-C130

NOTES:

1. DIMENSIONS ARE IN MILLIMETERS (INCHES).
2. TOLERANCE ± 0.1 mm UNLESS OTHERWISE NOTED.

Device Selection Guide

Package Dimension (mm)	White	Package Description
1.6 (L) x 0.8 (W) x 0.6 (H)	HSMW-C191	Untinted, Diffused
1.6 (L) x 0.8 (W) x 0.35 (H)	HSMW-C130	Untinted, Diffused
3.4 (L) x 1.25 (W) x 1.1 (H) ^[2]	HSMW-C265	Untinted, Diffused
1.6 (L) x 0.8 (W) x 0.4 (H)	HSMW-C197	Untinted, Diffused
1.6 (L) x 0.6 (W) x 1.0 (H)	HSMW-C120	Untinted, Diffused

Notes:

1. Right angle package.
2. Reverse mount package.

Absolute Maximum Ratings at T_A = 25°C

Parameter	HSMW-Cxxx	Units
DC Forward Current ^[1]	20	mA
Power Dissipation	78	mW
Reverse Voltage (I _R = 100 μA)	5	V
LED Junction Temperature	95	°C
Operating Temperature Range	-30 to +85	°C
Storage Temperature Range	-40 to +85	°C
Soldering Temperature	See reflow soldering profile (Figures 10 & 11)	

Note:

1. Derate linearly as shown in Figure 4.

Electrical Characteristics at T_A = 25°C

Part Number	Forward Voltage V _F (Volts) @ I _F = 20 mA ^[1]		Reverse Breakdown V _R (Volts) @ I _R = 100 μA	Capacitance C (pF), V _F = 0, f = 1 MHz	Thermal Resistance R _{θJ-PIN} (°C/W)
	Typ.	Max.	Min.	Typ.	Typ.
HSMW-Cxxx	3.6	3.9	5	55	450

Note:

1. V_F tolerance: ±0.1 V.

Optical Characteristics at T_A = 25°C

Part Number	Luminous Intensity I _v (mcd) @ 20 mA ^[1, 4]		Chromaticity Coordinates ^[2] Typ.		Viewing Angle 2 θ _{1/2} Degrees ^[3]	Luminous Efficacy η _v (lm/w) Typ.
	Min.	Typ.	x	y	Typ.	
HSMW-C130	45	150	0.29	0.27	145	240
HSMW-C191	71.5	200	0.29	0.27	140	240
HSMW-C265	71.5	180	0.29	0.27	150	240
HSMW-C120	45	160	0.29	0.27	155	240
HSMW-C197	45	160	0.29	0.27	130	240

Notes:

1. The luminous intensity, I_v, is measured at the peak of the spatial radiation pattern which may not be aligned with the mechanical axis of the lamp package.
2. The dominant wavelength, λ_d, is derived from the CIE Chromaticity Diagram and represents the perceived color of the device.
3. θ_{1/2} is the off-axis angle where the luminous intensity is 1/2 the peak intensity.
4. Luminous intensity (I_v) tolerance: ± 15%.

Light Intensity (I_v) Bin Limits^[1]

Bin ID	Intensity (mcd)	
	Min.	Max.
A	0.11	0.18
B	0.18	0.29
C	0.29	0.45
D	0.45	0.72
E	0.72	1.10
F	1.10	1.80
G	1.80	2.80
H	2.80	4.50
J	4.50	7.20
K	7.20	11.20
L	11.20	18.00
M	18.00	28.50
N	28.50	45.00
P	45.00	71.50
Q	71.50	112.50
R	112.50	180.00
S	180.00	285.00
T	285.00	450.00
U	450.00	715.00
V	715.00	1125.00
W	1125.00	1800.00
X	1800.00	2850.00
Y	2850.00	4500.00

Tolerance: ± 15%

Note:

1. Bin categories are established for classification of products. Products may not be available in all categories. Please contact your Avago representative for information on currently available bins.

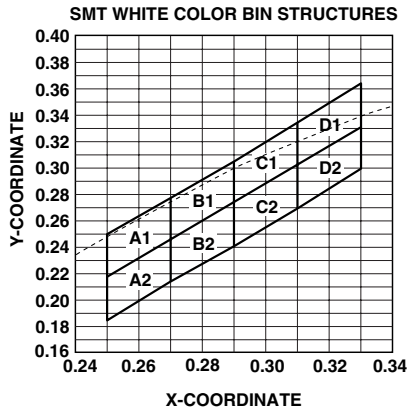

Figure 1. Color bin limits (CIE 1931 Chromaticity Diagram) [Tolerance: ± 0.02].

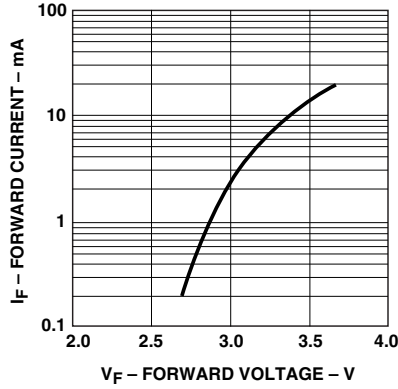

Figure 2. Forward current vs. forward voltage.

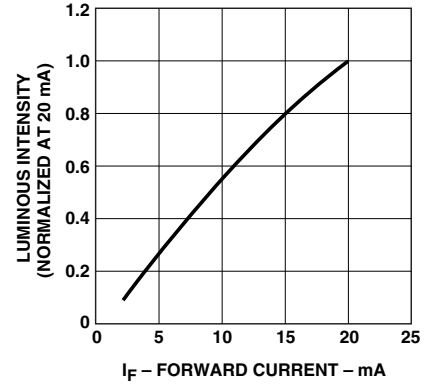

Figure 3. Luminous intensity vs. forward current.

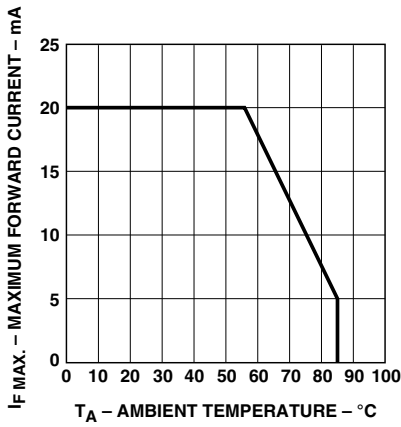

Figure 4. Maximum forward current vs. ambient temperature.

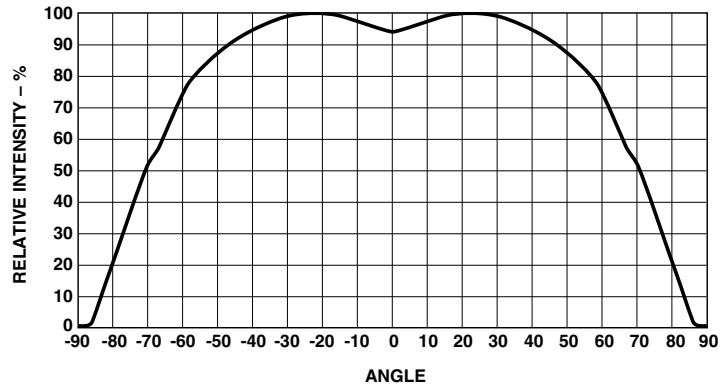

Figure 5. Relative intensity vs. angle for HSMW-C191.

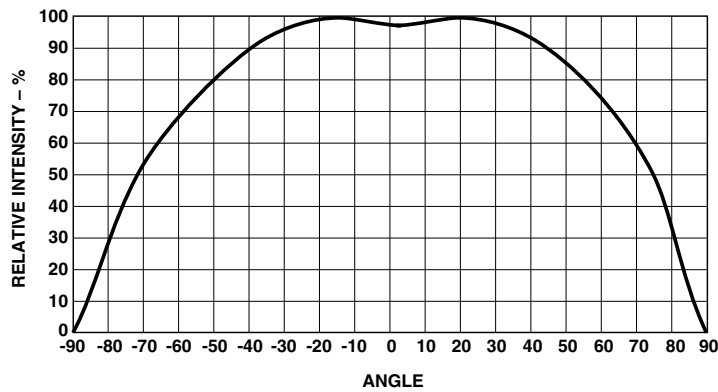

Figure 6. Relative intensity vs. angle for HSMW-C130.

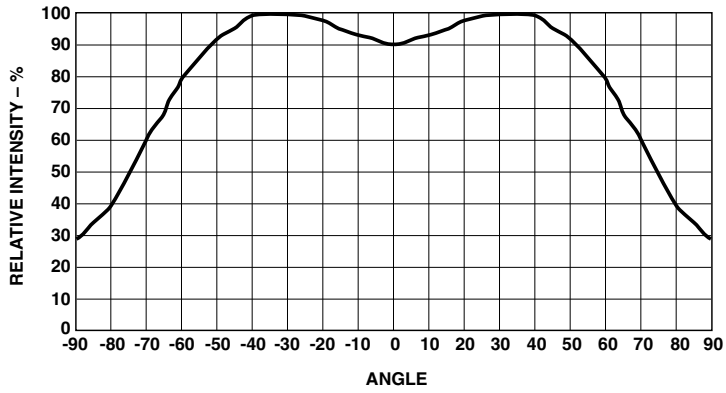

Figure 7. Relative intensity vs. angle for HSMW-C265.

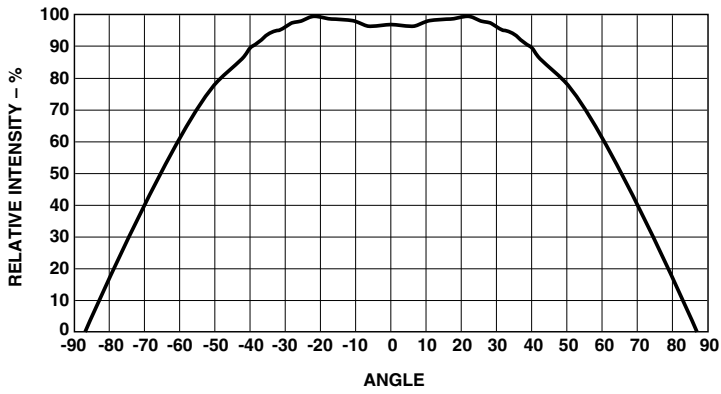

Figure 8. Relative intensity vs. angle for HSMW-C197.

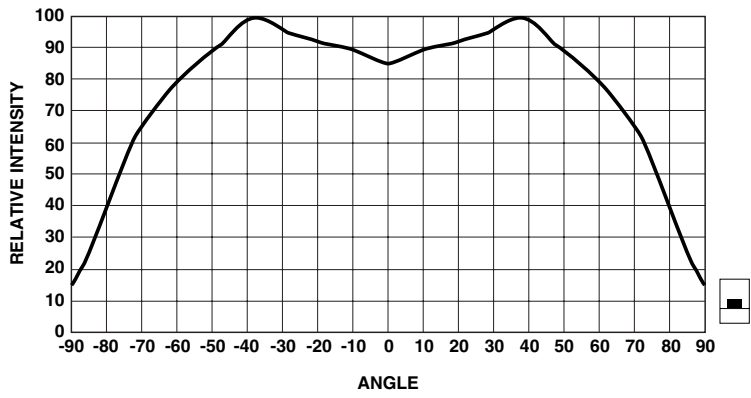
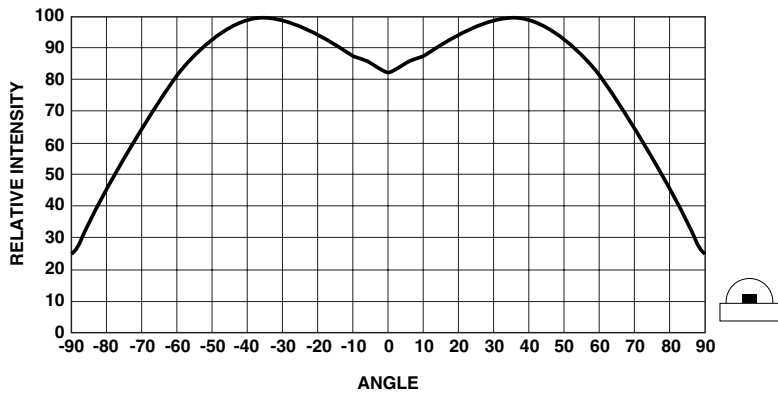

Figure 9. Relative intensity vs. angle for HSMW-C120.

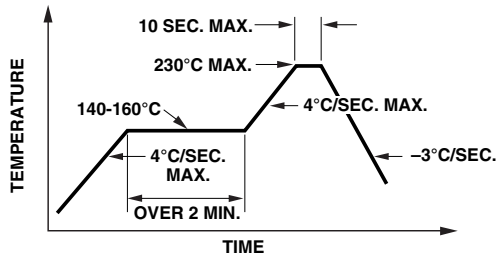

Figure 10. Recommended reflow soldering profile.

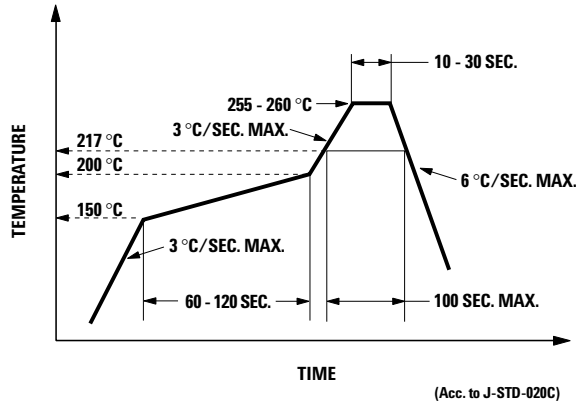

Figure 11. Recommended Pb-free reflow soldering profile.

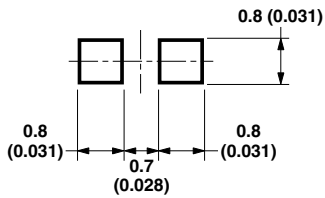

Figure 12. Recommended soldering pattern for HSMW-C191, HSMW-C130, and HSMW-C197.

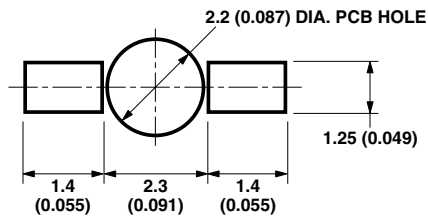

Figure 13. Recommended soldering pad pattern for HSMW-C265.

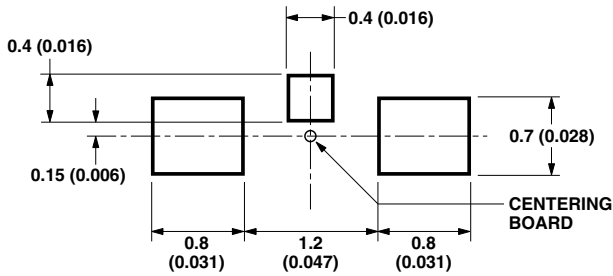

Figure 14. Recommended soldering pad pattern for HSMW-C120.

NOTE:
1. DIMENSIONS ARE IN MILLIMETERS (INCHES).

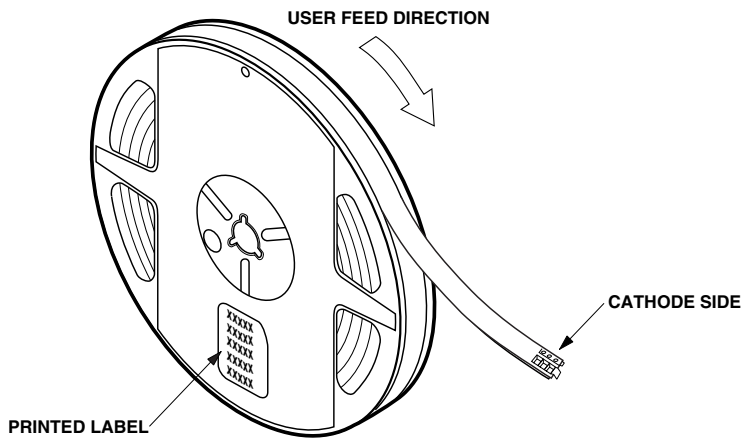

Figure 15. Reeling orientation.

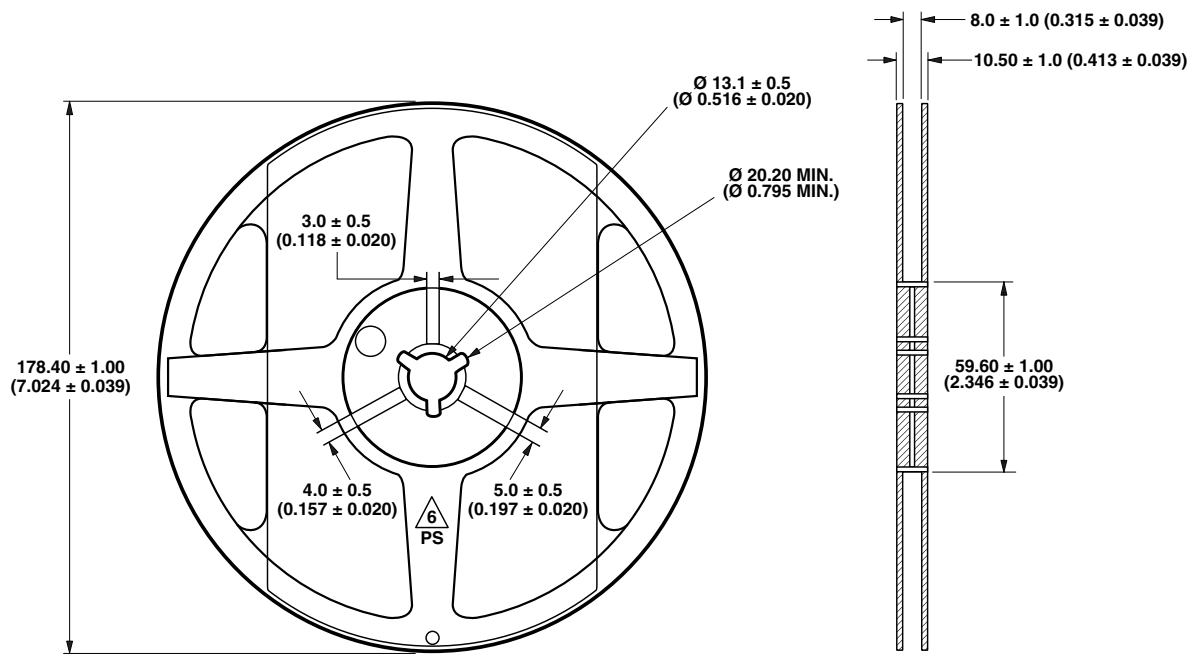

Figure 16. Reel dimensions.

NOTE:
1. DIMENSIONS ARE IN MILLIMETERS (INCHES).

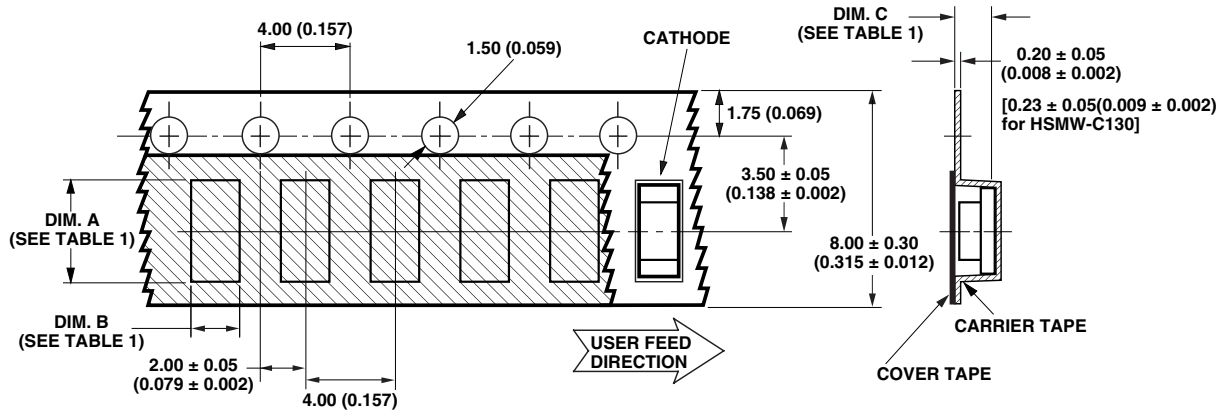

TABLE 1
DIMENSIONS IN MILLIMETERS (INCHES)

PART NUMBER	DIM. A ± 0.10 (± 0.004)	DIM. B ± 0.10 (± 0.004)	DIM. C ± 0.10 (± 0.004)
HSMW-C191 SERIES	1.85 (0.073)	0.88 (0.035)	0.88 (0.035)
HSMW-C197 SERIES	1.75 (0.069)	0.95 (0.037)	0.60 (0.024)
HSMW-C120 SERIES	1.90 (0.075)	1.15 (0.045)	0.80 (0.031)
HSMW-C130 SERIES	1.75 (0.069)	0.88 (0.035)	0.50 (0.020)

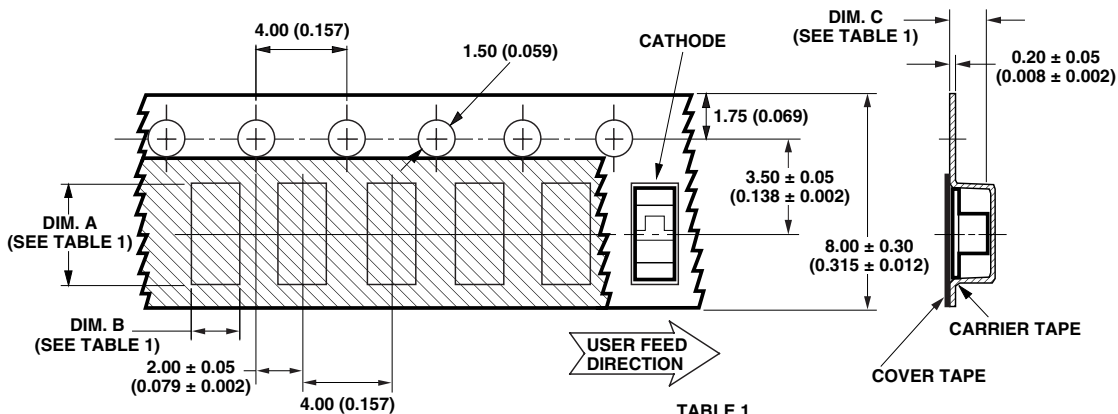
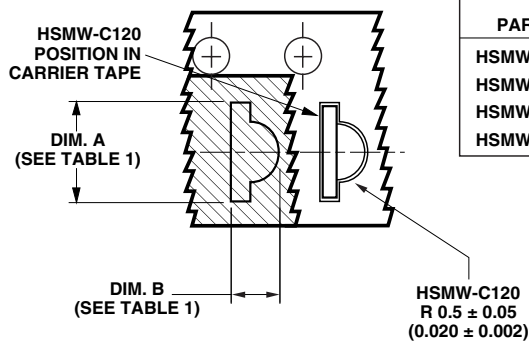

TABLE 1
DIMENSIONS IN MILLIMETERS (INCHES)

PART NUMBER	DIM. A ± 0.10 (0.004)	DIM. B ± 0.10 (0.004)	DIM. C ± 0.10 (0.004)
HSMx-C265 SERIES	3.70 (0.146)	1.45 (0.057)	1.30 (0.051)

Figure 17. Tape dimensions.

NOTE:
1. DIMENSIONS ARE IN MILLIMETERS (INCHES).

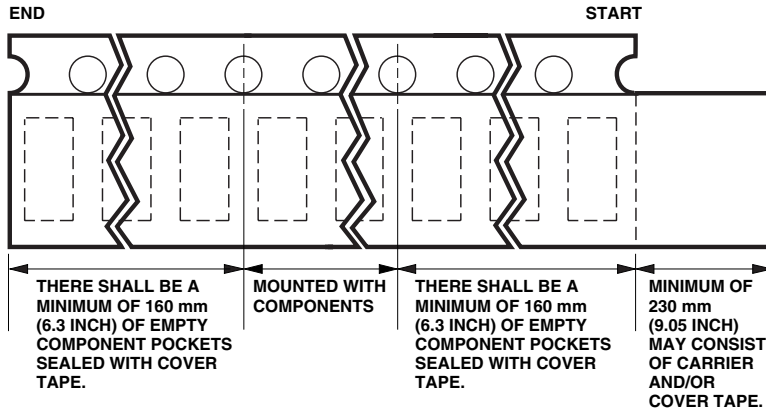

Figure 18. Tape leader and trailer dimensions.

Convective IR Reflow Soldering

For more information on IR reflow soldering, refer to Application Note 1060, *Surface Mounting SMT LED Indicator Components*.

Storage Condition:

5 to 30°C @ 60% RH max.

Baking is required under the condition:

1. Humidity Indicator Card is > 10% when read at $23 \pm 5^\circ\text{C}$.
2. Device expose to factory conditions < $30^\circ\text{C}/60\% \text{RH}$ more than 672 hours.

Baking recommended condition:
 $60 \pm 5^\circ\text{C}$ for 20 hours.

For product information and a complete list of distributors, please go to our website: www.avagotech.com

Avago, Avago Technologies, and the A logo are trademarks of Avago Technologies Limited in the United States and other countries. Data subject to change. Copyright © 2006 Avago Technologies Limited. All rights reserved. Obsoletes 5989-0395EN AV01-0685EN December 10, 2006

AVAGO
TECHNOLOGIES