

HSMB-C1xx

Surface Mount ChipLEDs



Data Sheet

HSMB-C112, HSMB-C172, HSMB-C192,
HSMB-C196, HSMB-C152



Description

This series of low current blue ChipLEDs is designed specifically for low current application. This makes them very suitable for cellular phone and portable equipment which runs off a battery. These parts are according to industry standard footprint. In order to facilitate automated pick and place operation, these ChipLEDs are shipped in tape and reel, with 4000 units per reel for HSMB-C172/192/196 series and 3000 units per reel for the HSMB-C112/152 series. These parts are compatible with IR soldering.

Features

- Various size and mount options available
- Industry standard footprint
- Operating temperature range of -30°C to $+85^{\circ}\text{C}$
- Compatible with IR solder reflow
- Available in 8 mm tape on 7" diameter reel

Applications

- LCD backlighting
- Keypad backlighting
- Pushbutton backlighting
- Symbol indicator
- Front panel indicator

CAUTION: HSMB-C1xx LEDs are Class 1 ESD sensitive per MIL-STD-1686. Please observe appropriate precautions during handling and processing. Refer to Avago Technologies Application Note AN-1142 for additional details.

Package Dimensions

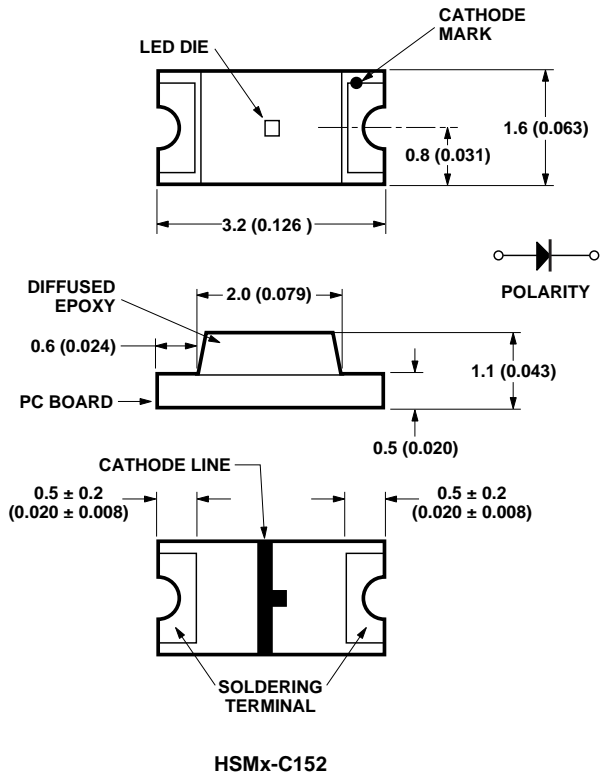
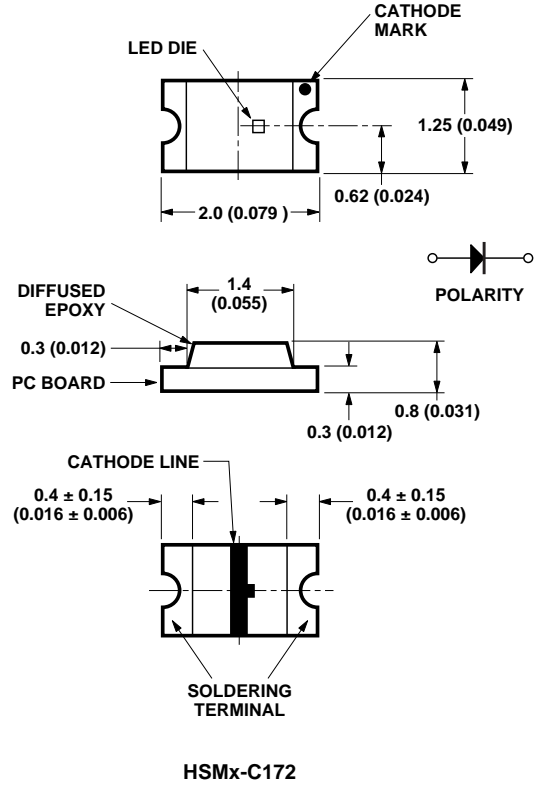
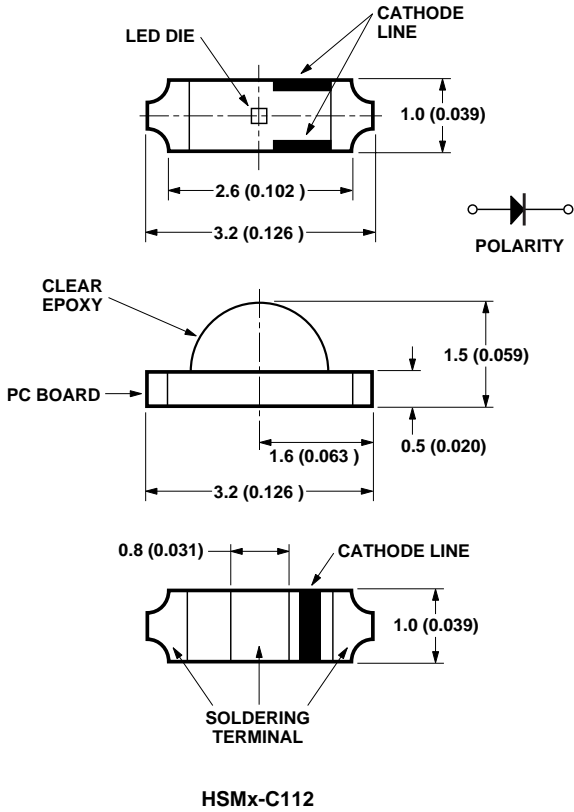

- NOTES:**
 1. ALL DIMENSIONS IN MILLIMETERS (INCHES).
 2. TOLERANCE IS ± 0.1 mm (± 0.004 IN.) UNLESS OTHERWISE SPECIFIED.

Package Dimensions

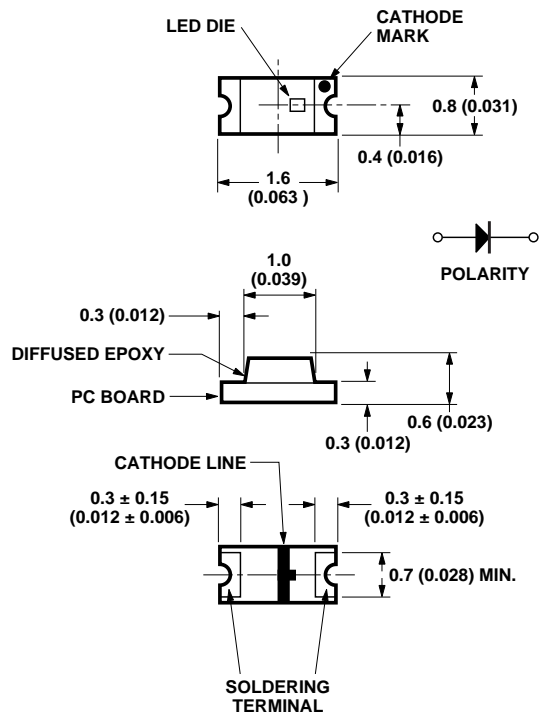
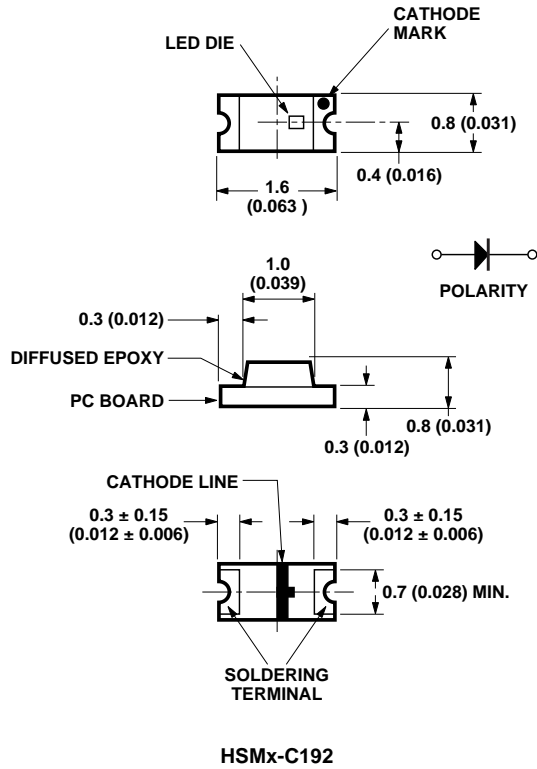

- NOTES:
1. ALL DIMENSIONS IN MILLIMETERS (INCHES).
 2. TOLERANCE IS ± 0.1 mm (± 0.004 IN.) UNLESS OTHERWISE SPECIFIED.

Device Selection Guide

Package Dimension (mm)	GaN Blue	Package Description
1.6 (L) x 0.8 (W) x 0.6 (H)	HSMB-C196	Untinted, Diffused
1.6 (L) x 0.8 (W) x 0.8 (H)	HSMB-C192	Untinted, Diffused
2.0 (L) x 1.25 (W) x 0.8 (H)	HSMB-C172	Untinted, Diffused
3.2 (L) x 1.0 (W) x 1.5 (H) ^[1]	HSMB-C112	Untinted, Nondiffused
3.2 (L) x 1.6 (W) x 1.1 (H)	HSMB-C152	Untinted, Diffused

Note:

1. Right angle package.

Absolute Maximum Ratings at T_A = 25°C

Parameter	HSMB-C112/172/192/196/152	Units
DC Forward Current ^[1]	10	mA
Power Dissipation	46	mW
Reverse Voltage (I _R = 100 μA)	5	V
LED Junction Temperature	95	°C
Operating Temperature Range	-30 to +85	°C
Storage Temperature Range	-40 to +85	°C
Soldering Temperature	See reflow soldering profile (Figure 7 & 8)	

Note:

1. Derate linearly as shown in Figure 4.

Electrical Characteristics at T_A = 25°C

Part Number	Forward Voltage V _F (Volts) @ I _F = 10 mA		Reverse Breakdown V _R (Volts) @ I _R = 100 μA	Capacitance C (pF), V _F = 0, f = 1 MHz	Thermal Resistance R _{θJ-PIN} (°C/W)
	Typ.	Max.	Min.	Typ.	Typ.
HSMB-C152/C172/C192/C196	4.1	4.6	5	43	550
HSMB-C112	4.1	4.6	5	43	550

V_F Tolerance: ±0.1 V

Optical Characteristics at T_A = 25°C

Part Number	Luminous Intensity I _v (mcd) @ 10 mA ^[1]		Peak Wavelength λ _{peak} (nm)	Color Dominant Wavelength λ _d ^[2] (nm)	Viewing Angle 2 θ _{1/2} Degrees ^[3]	Luminous Efficacy η _v (lm/w)
	Min.	Typ.	Typ.	Typ.	Typ.	Typ.
HSMB-C112	1.1	3.1	428	462	130	55
HSMB-C172	1.1	3.0	428	462	170	55
HSMB-C192	1.1	3.0	428	462	170	55
HSMB-C196	1.1	3.0	428	462	170	55
HSMB-C152	1.1	3.0	428	462	170	55

Notes:

- The luminous intensity I_v is measured at the peak of the spatial radiation pattern which may not be aligned with the mechanical axis of the lamp package.
- The dominant wavelength λ_d is derived from the CIE Chromaticity Diagram and represents the perceived color of the device.
- θ_{1/2} is the off-axis angle where the luminous intensity is 1/2 the peak intensity.

Blue Color Bin Limits^[1]

Bin ID	Dom. Wavelength (nm)	
	Min.	Max.
A	460	465
B	465	470
C	470	475
D	475	480

Tolerance: ± 1 nm

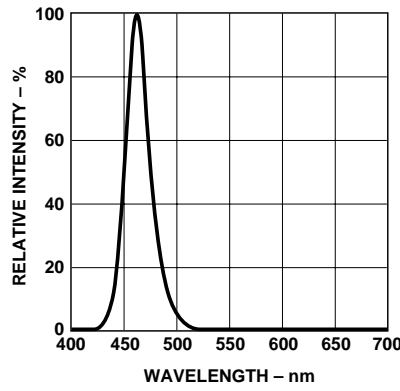

Figure 1. Relative intensity vs. wavelength.

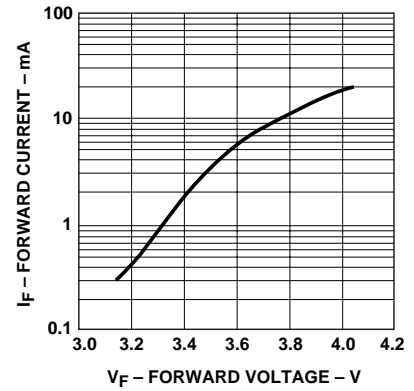

Figure 2. Forward current vs. forward voltage.

Light Intensity (I_v) Bin Limits^[1]

Bin ID	Intensity (mcd)	
	Min.	Max.
A	0.11	0.18
B	0.18	0.29
C	0.29	0.45
D	0.45	0.72
E	0.72	1.10
F	1.10	1.80
G	1.80	2.80
H	2.80	4.50
J	4.50	7.20
K	7.20	11.20
L	11.20	18.00
M	18.00	28.50
N	28.50	45.00
P	45.00	71.50
Q	71.50	112.50
R	112.50	180.00
S	180.00	285.00
T	285.00	450.00
U	450.00	715.00
V	715.00	1125.00
W	1125.00	1800.00
X	1800.00	2850.00
Y	2850.00	4500.00

Tolerance: $\pm 15\%$

Note:

- Bin categories are established for classification of products. Products may not be available in all categories. Please contact your Avago representative for information regarding currently available bins.

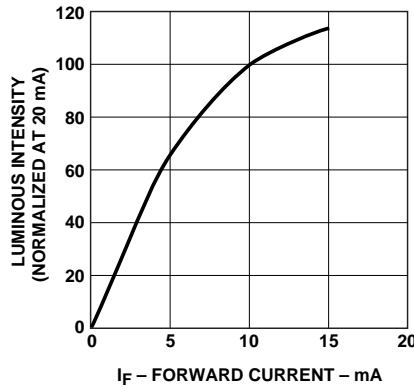

Figure 3. Luminous intensity vs. forward current.

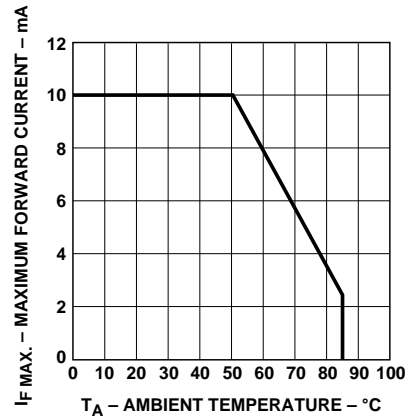

Figure 4. Maximum forward current vs. ambient temperature.

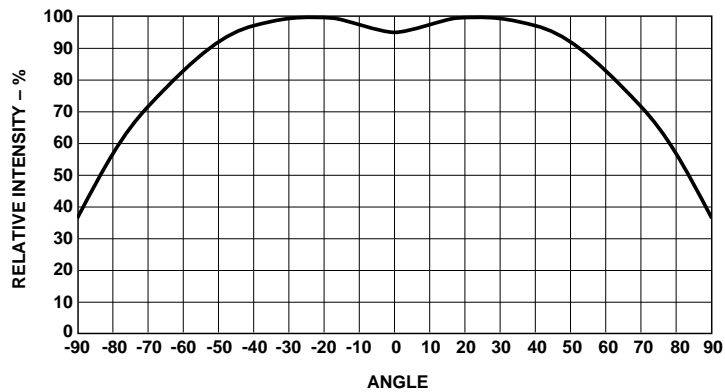

Figure 5. Relative intensity vs. angle for HSMx-C172, C192, C196, and C152.

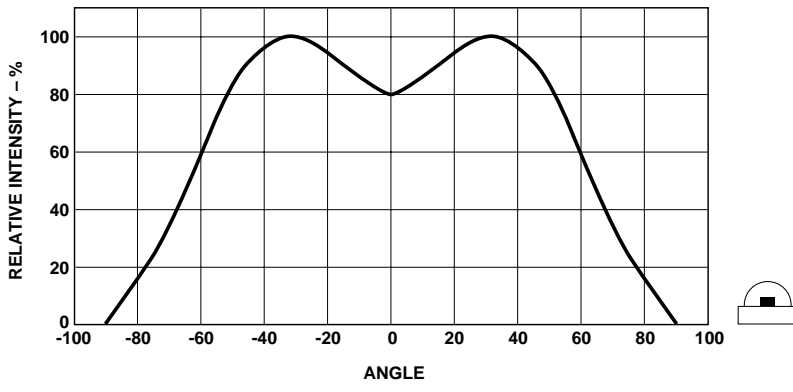

Figure 6. Relative intensity vs. angle for HSMx-C112.

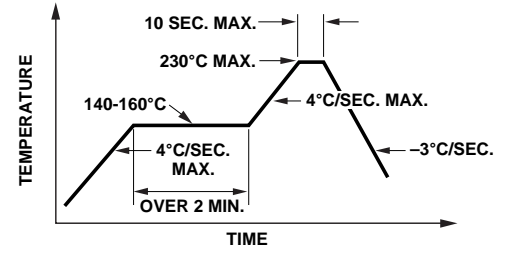
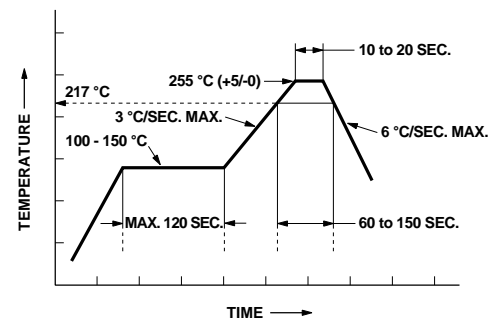
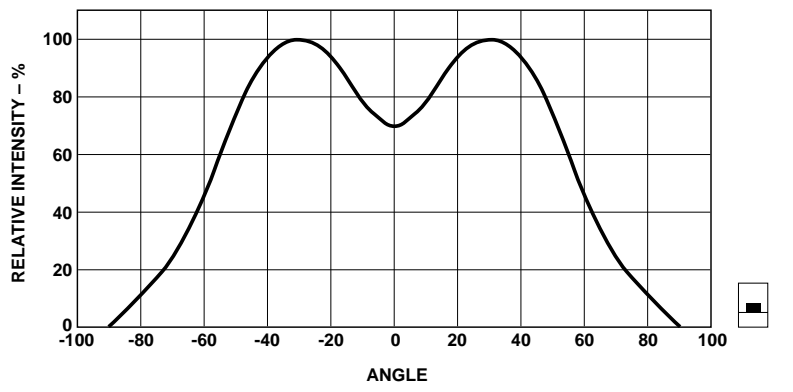

Figure 7. Recommended reflow soldering profile.



* THE TIME FROM 25 °C TO PEAK TEMPERATURE = 6 MINUTES MAX.

Figure 8. Recommended Pb-free reflow soldering profile.

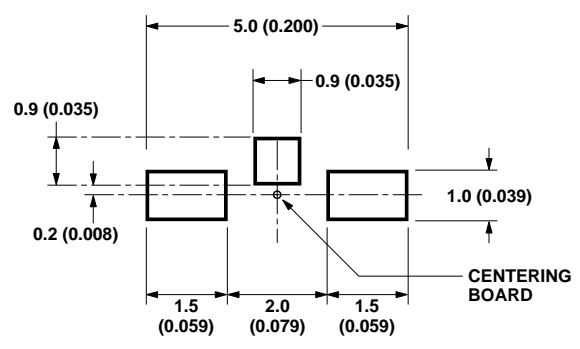

Figure 9. Recommended soldering pattern for HSMx-C112.

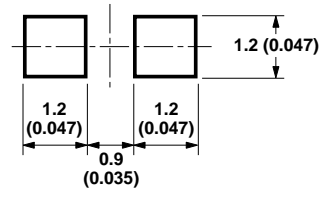

Figure 10. Recommended soldering pattern for HSMx-C172.

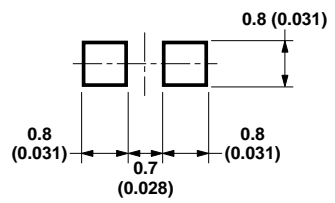

Figure 11. Recommended soldering pattern for HSMx-C192 and HSMx-C196.

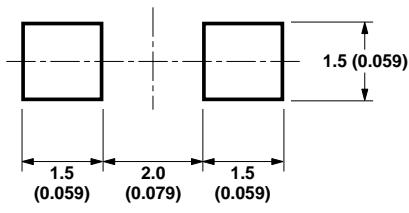

Figure 12. Recommended soldering pattern for HSMx-C152.

NOTE:
1. ALL DIMENSIONS IN MILLIMETERS (INCHES).

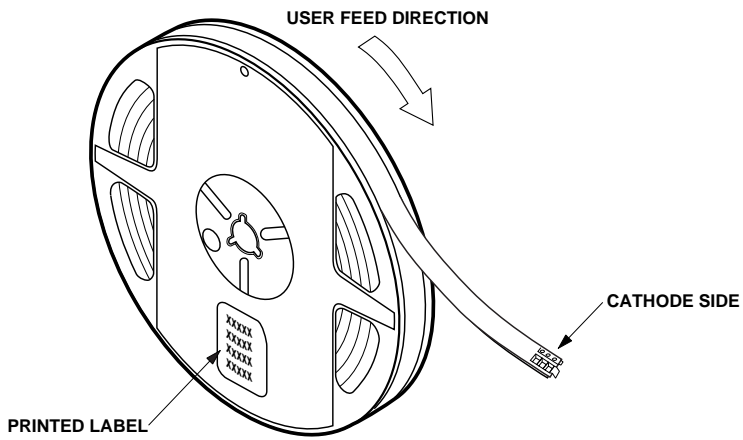
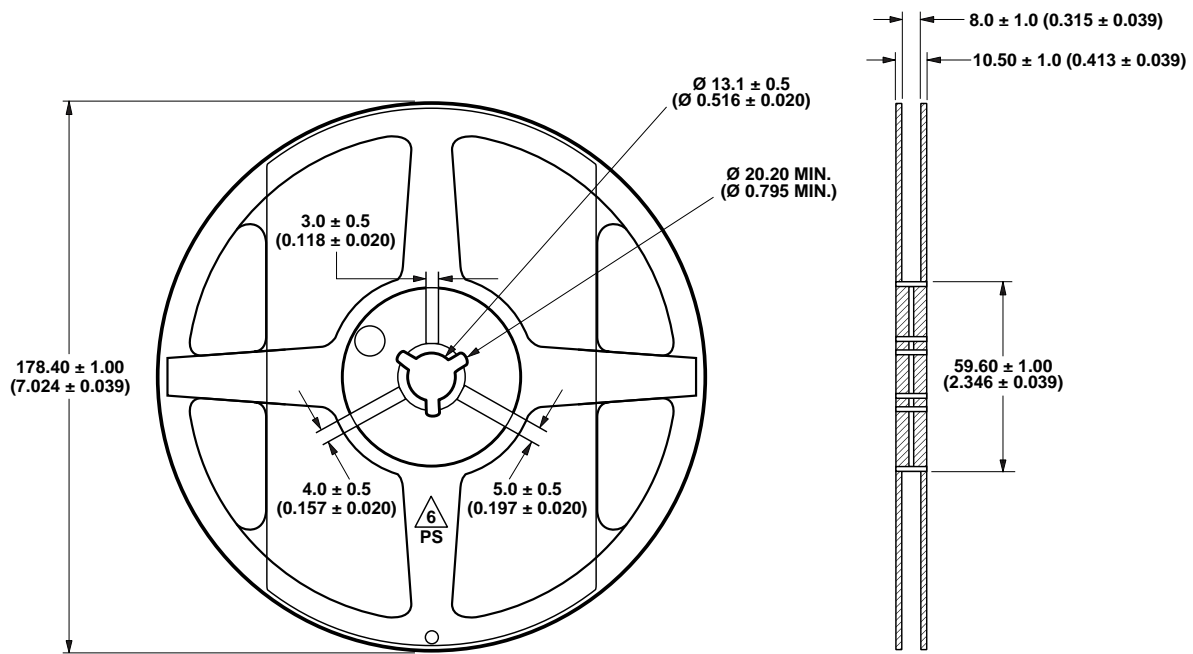

Figure 13. Reeling orientation.



NOTE:
1. ALL DIMENSIONS IN MILLIMETERS (INCHES).

Figure 14. Reel dimensions.

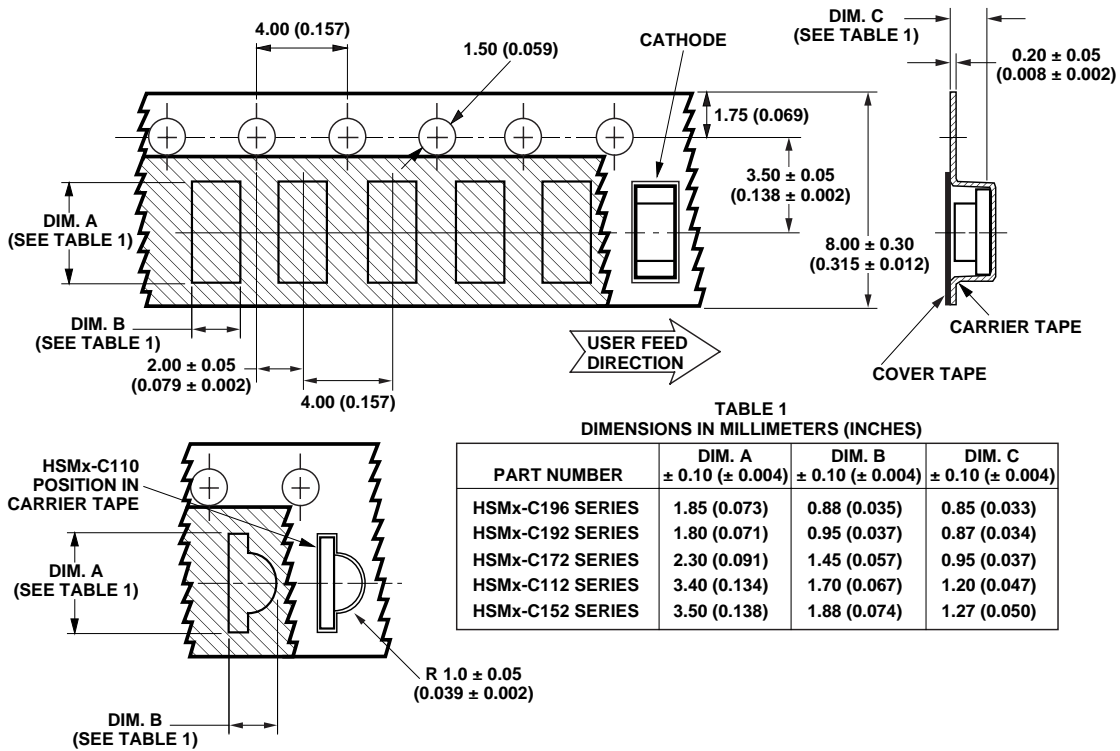

Figure 15. Tape dimensions.

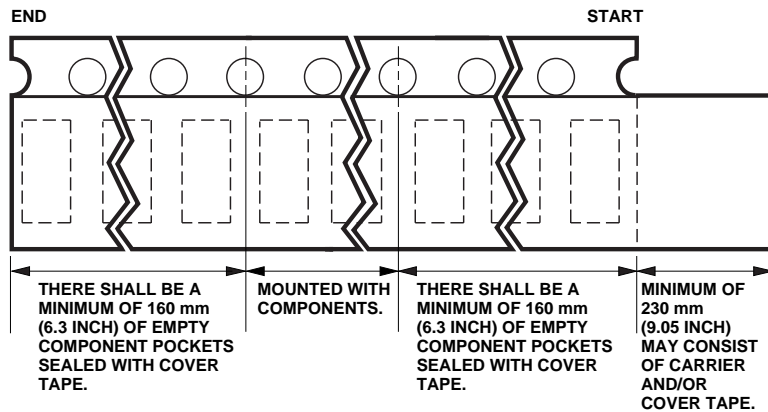

Figure 16. Tape leader and trailer dimensions.

- NOTES:
 1. ALL DIMENSIONS IN MILLIMETERS (INCHES).
 2. TOLERANCE IS ± 0.1 mm (± 0.004 IN.) UNLESS OTHERWISE SPECIFIED.

Convective IR Reflow Soldering

For more information on IR reflow soldering, refer to Application Note 1060, *Surface Mounting SMT LED Indicator Components*.

Storage Condition:

5 to 30°C @ 60% RH max.

Baking is required under the condition:

- the blue silica gel indicator becoming white/transparent color
- the pack has been open for more than 1 week

Baking recommended condition:
 60 \pm 5°C for 20 hours.

For product information and a complete list of distributors, please go to our website: www.avagotech.com

Avago, Avago Technologies, and the A logo are trademarks of Avago Technologies Limited in the United States and other countries.
Data subject to change. Copyright © 2006 Avago Technologies Limited. All rights reserved. Obsoletes 5988-7127EN
5989-0416EN June 19, 2006

