

Agilent HLMP-4100/4101

T-1³/₄ (5 mm)

Double Heterojunction AlGaAs

Very High Intensity Red LED Lamps

Data Sheet

Description

These solid state LED lamps utilize newly developed double heterojunction (DH) AlGaAs/GaAs material technology. This LED material has outstanding light output efficiency over a wide range of drive currents. The lamp package has a tapered lens designed to

concentrate the luminous flux into a narrow radiation pattern to achieve a very high intensity. The LED color is deep red at the dominant wavelength of 637 nanometers. These lamps may be DC or pulse driven to achieve desired light output.

Features

- 1000 mcd at 20 mA
- Very high intensity at low drive currents
- Narrow viewing angle
- Outstanding material efficiency
- Low forward voltage
- CMOS/MOS compatible
- TTL compatible
- Deep red color

Applications

- Bright ambient lighting conditions
- Emitter/detector and signaling applications
- General use

Package Dimensions

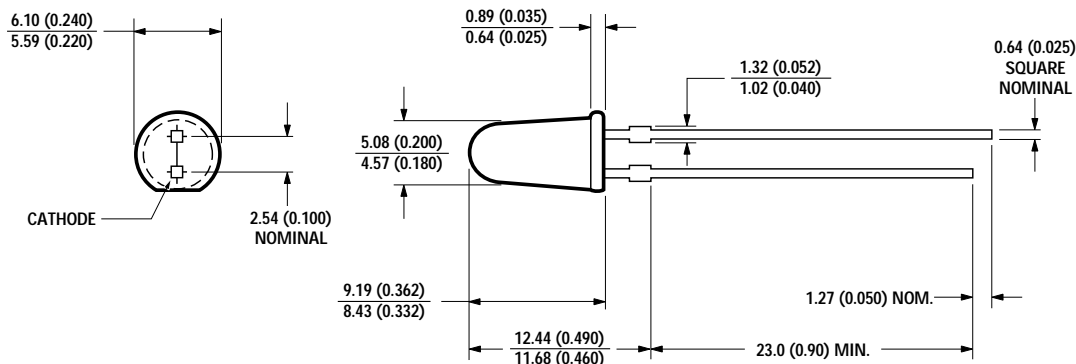

Selection Guide

Device HLMP-	Luminous Intensity Iv (mcd) at 20 mA			2θ _{1/2} ^[1] Degree
	Min.	Typ.	Max.	
4100	500.0	750.0	–	8
4101	700.0	1000.0	–	8
4101-ST0xx	1400.0	2700.0	4000.0	8

Note:

1. θ^{1/2} is the angle from optical centerline where the luminous intensity is 1/2 the optical centerline value.

Part Numbering System

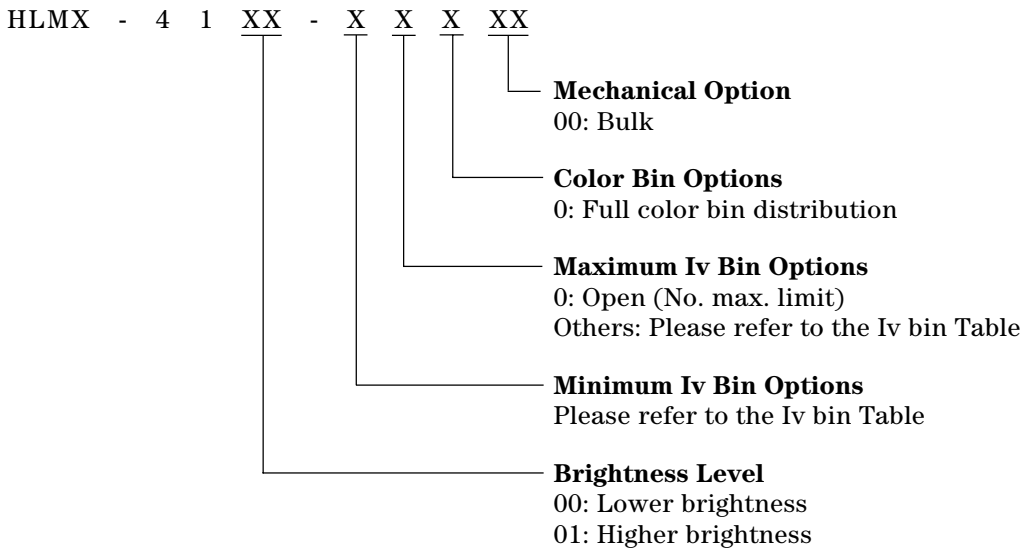

Notes:

1. '0' indicates no maximum intensity limit.
2. '0' indicates full color distribution.

Absolute Maximum Ratings at $T_A = 25^\circ\text{C}$

Parameter	Maximum Rating	Units
Peak Forward Current ^[1, 2]	300	mA
Average Forward Current ^[2]	20	mA
DC Current ^[3]	30	mA
Power Dissipation	87	mW
Reverse Voltage ($I_R = 100 \mu\text{A}$)	5	V
Transient Forward Current (10 μs Pulse) ^[4]	500	mA
Operating Temperature Range	-20 to +100	$^\circ\text{C}$
Storage Temperature Range	-55 to +100	$^\circ\text{C}$

Notes:

1. Maximum I_{PEAK} at $f = 1 \text{ kHz}$, $DF = 6.7\%$.
2. Refer to Figure 6 to establish pulsed operating conditions.
3. Derate linearly as shown in Figure 5.
4. The transient peak current is the maximum non-recurring peak current the device can withstand without damaging the LED die and wire bonds. It is not recommended that the device be operated at peak currents beyond the Absolute Maximum Peak Forward Current.

Electrical/Optical Characteristics at $T_A = 25^\circ\text{C}$

Symbol	Description	Min.	Typ.	Max.	Unit	Test Condition
V_F	Forward Voltage		1.8	2.2	V	20 mA
V_R	Reverse Breakdown Voltage	5.0	15.0		V	$I_R = 100 \mu\text{A}$
λ_{PEAK}	Peak Wavelength		650		nm	Measurement at peak
λ_d	Dominant Wavelength		642		nm	Note 1
$\Delta\lambda_{1/2}$	Spectral Line Halfwidth		20		nm	
τ_S	Speed of Response		30		ns	Exponential Time Constant, $e^{-t/2}$
C	Capacitance		30		pF	$V_F = 0$, $f = 1 \text{ MHz}$
θ_{JC}	Thermal Resistance		220		$^\circ\text{C}/\text{W}$	Junction to Cathode Lead
η_V	Luminous Efficacy		80		1 m/W	Note 2

Notes:

1. The dominant wavelength, λ_d , is derived from the CIE chromaticity diagram and represents the color of the device.
2. The radiant intensity, I_e , in watts per steradian, may be found from the equation $I_e = I_V/\eta_V$, where I_V is the luminous intensity in candelas and η_V is luminous efficacy in lumens/watt.
3. The approximate total luminous flux output within a cone angle of 2θ about the optical axis, $\phi_V(2\theta)$, may be obtained from the following formula:
 $\phi_V(2\theta) = [\phi_V(\theta)/I_V(0)]I_V$; Where: $\phi_V(\theta)/I_V(0)$ is obtained from Figure 7.

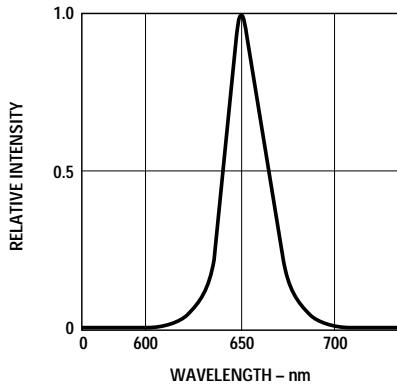

Figure 1. Relative intensity vs. wavelength.

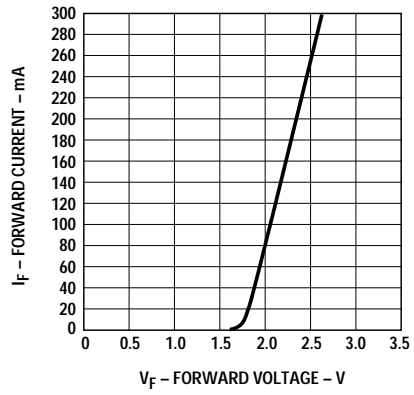

Figure 2. Forward current vs. forward voltage.

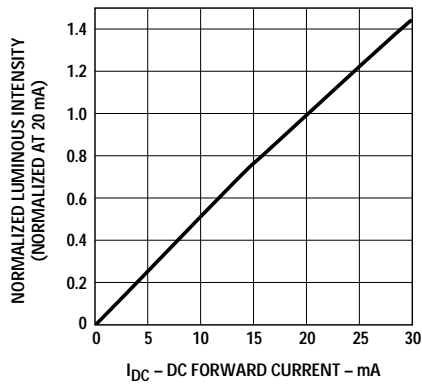

Figure 3. Relative luminous intensity vs. dc forward current.

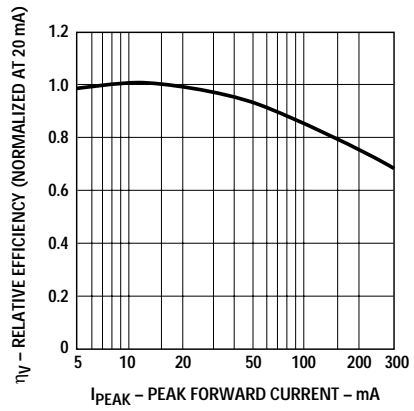

Figure 4. Relative efficiency vs. peak forward current.

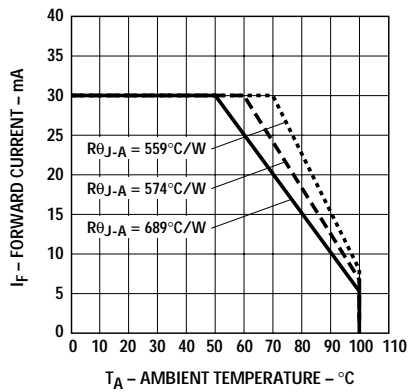

Figure 5. Maximum forward dc current vs. ambient temperature derating based on $T_J \text{ MAX.} = 110^\circ\text{C}$.

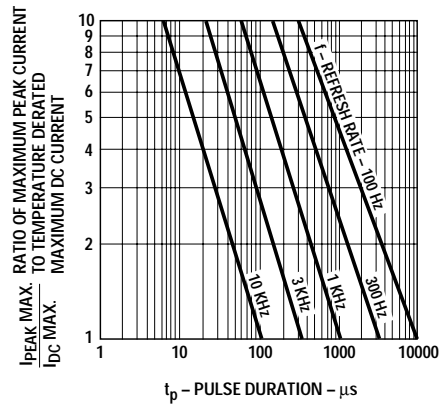

Figure 6. Maximum tolerable peak current vs. peak duration ($I_{\text{PEAK MAX.}}$ determined from temperature derated $I_{\text{DC MAX.}}$).

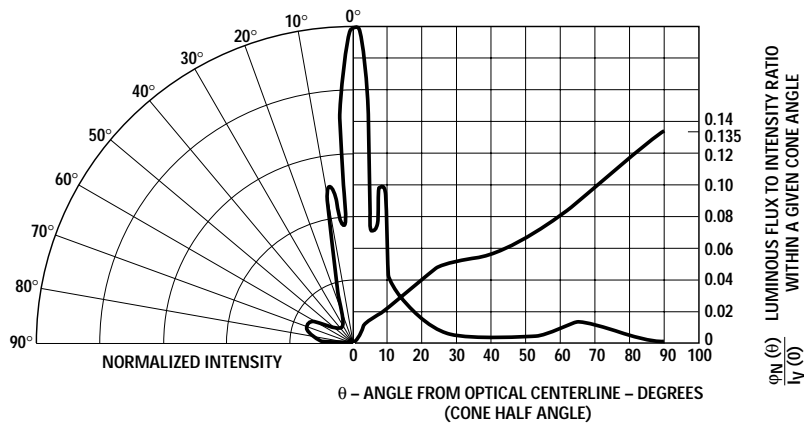

Figure 7. Relative luminous intensity vs. angular displacement.

Intensity Bin Limits

Color	Bin	Intensity Range (mcd)	
		Min.	Max.
Red	P	540.0	850.0
	Q	850.0	1200.0
	R	1200.0	1700.0
	S	1700.0	2400.0
	T	2400.0	3400.0
	U	3400.0	4900.0
	V	4900.0	7100.0
	W	7100.0	10200.0
	X	10200.0	14800.0
	Y	14800.0	21400.0
Z	21400.0	30900.0	

Tolerance for each bin limit is $\pm 18\%$.

Mechanical Option Matrix

Mechanical Option Code	Definition
00	Bulk Packaging, minimum increment 500 pcs/bag

Note:

All categories are established for classification of products. Products may not be available in all categories. Please contact your local Agilent representative for further clarification/information.

Precautions

Lead Forming

- The leads of an LED lamp may be preformed or cut to length prior to insertion and soldering into PC board.
- If lead forming is required before soldering, care must be taken to avoid any excessive mechanical stress induced to LED package. Otherwise, cut the leads of LED to length after soldering process at room temperature. The solder joint formed will absorb the mechanical stress of the lead cutting from traveling to the LED chip die attach and wirebond.
- It is recommended that tooling made to precisely form and cut the leads to length rather than rely upon hand operation.

Soldering Conditions

- Care must be taken during PCB assembly and soldering process to prevent damage to LED component.
- The closest LED is allowed to solder on board is 1.59 mm below the body (encapsulant epoxy) for those parts without standoff.
- Recommended soldering conditions:

	Wave Soldering	Manual Solder Dipping
Pre-heat Temperature	105 °C Max.	–
Pre-heat Time	30 sec Max.	–
Peak Temperature	250 °C Max.	260 °C Max.
Dwell Time	3 sec Max.	5 sec Max.

- Wave soldering parameter must be set and maintained according to recommended temperature and dwell time in the solder wave. Customer is advised to periodically check on the soldering profile to ensure the soldering profile used is always conforming to recommended soldering condition.
- If necessary, use fixture to hold the LED component in proper orientation with respect to the PCB during soldering process.
- Proper handling is imperative to avoid excessive thermal stresses to LED components when heated. Therefore, the soldered PCB must be allowed to cool to room temperature, 25°C, before handling.
- Special attention must be given to board fabrication, solder masking, surface plating and lead holes size and component orientation to assure solderability.
- Recommended PC board plated through hole sizes for LED component leads:

LED Component Lead Size	Diagonal	Plated Through Hole Diameter
0.457 x 0.457 mm (0.018 x 0.018 inch)	0.646 mm (0.025 inch)	0.976 to 1.078 mm (0.038 to 0.042 inch)
0.508 x 0.508 mm (0.020 x 0.020 inch)	0.718 mm (0.028 inch)	1.049 to 1.150 mm (0.041 to 0.045 inch)

Note: Refer to application note AN1027 for more information on soldering LED components.

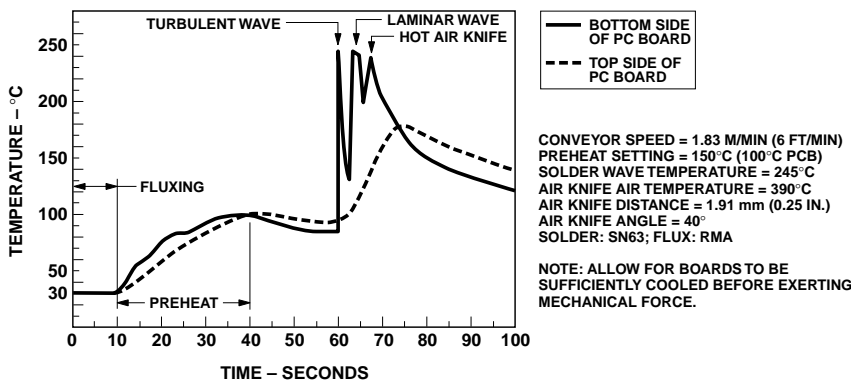

Figure 8. Recommended wave soldering profile.

www.agilent.com/semiconductors

For product information and a complete list of distributors, please go to our web site.

For technical assistance call:

Americas/Canada: +1 (800) 235-0312 or (916) 788-6763

Europe: +49 (0) 6441 92460

China: 10800 650 0017

Hong Kong: (+65) 6756 2394

India, Australia, New Zealand: (+65) 6755 1939

Japan: (+81 3) 3335-8152(Domestic/International), or 0120-61-1280(Domestic Only)

Korea: (+65) 6755 1989

Singapore, Malaysia, Vietnam, Thailand, Philippines, Indonesia: (+65) 6755 2044

Taiwan: (+65) 6755 1843

Data subject to change.

Copyright © 2004-2005 Agilent Technologies, Inc.

Obsoletes 5989-3261EN

November 12, 2005

5989-4268EN



Agilent Technologies