



## 16-Bit, Quad Voltage Output Digital-to-Analog Converter

### FEATURES

- Low Glitch: 1nV-s (typ)
- Low Power: 18mW
- Unipolar or Bipolar Operation
- Settling Time: 12μs to 0.003%
- 16-Bit Linearity and Monotonicity: -40°C to +85°C
- Programmable Reset to Mid-Scale or Zero-Scale
- Double-Buffered Data Inputs
- Internal Bandgap Voltage Reference
- Power-On Reset
- 3V to 5V Logic Interface

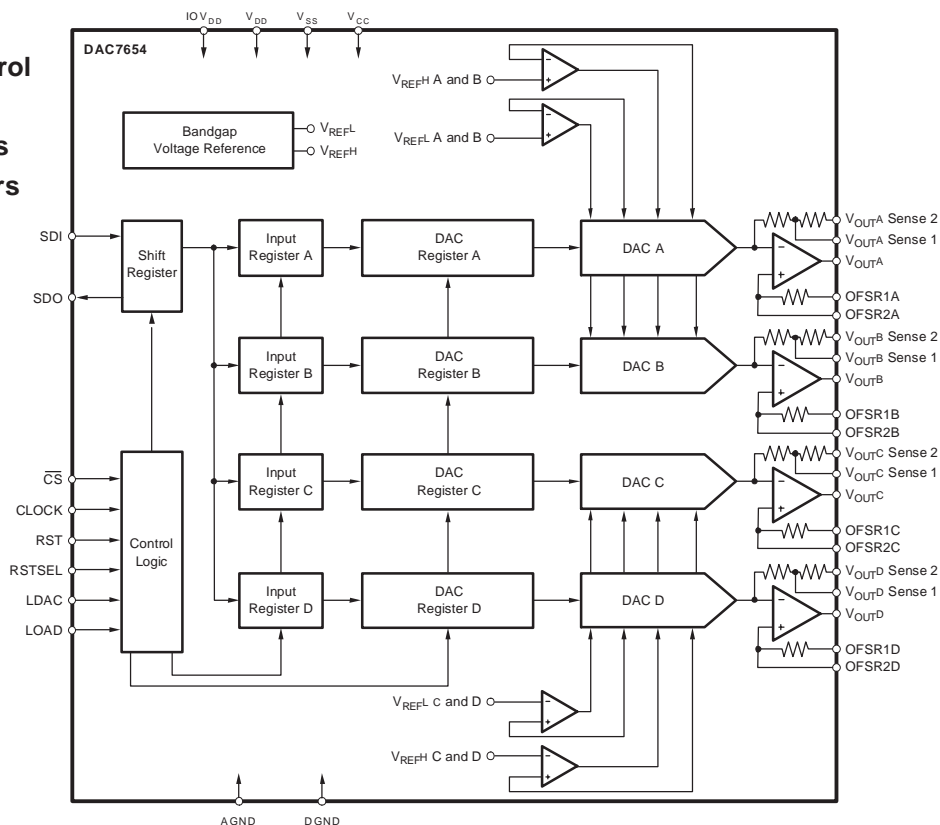
### APPLICATIONS

- Process Control
- Closed-Loop Servo-Control
- Motor Control
- Data Acquisition Systems
- DAC-per-Pin Programmers

### DESCRIPTION

The DAC7654 is a 16-bit, quad voltage output, digital-to-analog converter (DAC) with 16-bit monotonic performance over the specified temperature range. It accepts 24-bit serial input data, has double-buffered DAC input logic (allowing simultaneous update of all DACs), and provides a serial data output for daisy-chaining multiple DACs. Programmable asynchronous reset clears all registers to a mid-scale code of 8000h or to a zero-scale of 0000h. The DAC7654 can operate from a single +5V supply or from +5V and -5V supplies.

Low power and small size per DAC make the DAC7654 ideal for automatic test equipment, DAC-per-pin programmers, data acquisition systems, and closed-loop servo-control. The DAC7654 is available in an LQFP package and is specified for operation over the -40°C to +85°C temperature range.



This device has ESD-CDM sensitivity and special handling precautions must be taken.



Please be aware that an important notice concerning availability, standard warranty, and use in critical applications of Texas Instruments semiconductor products and disclaimers thereto appears at the end of this data sheet.

All trademarks are the property of their respective owners.

**ORDERING INFORMATION(1)**

| PRODUCT   | PACKAGE-LEAD | PACKAGE DESIGNATOR | SPECIFIED TEMPERATURE RANGE | PACKAGE MARKING | ORDERING NUMBER | TRANSPORT MEDIA, QUANTITY |
|-----------|--------------|--------------------|-----------------------------|-----------------|-----------------|---------------------------|
| DAC7654Y  | LQFP-64      | PM                 | -40°C to +85°C              | DAC7654Y        | DAC7654YT       | Tape and Reel, 250        |
|           |              |                    |                             |                 | DAC7654YR       | Tape and Reel, 1500       |
| DAC7654YB | LQFP-64      | PM                 | -40°C to +85°C              | DAC7654YB       | DAC7654YBT      | Tape and Reel, 250        |
|           |              |                    |                             |                 | DAC7654YBR      | Tape and Reel, 1500       |
| DAC7654YC | LQFP-64      | PM                 | -40°C to +85°C              | DAC7654YC       | DAC7654YCT      | Tape and Reel, 250        |
|           |              |                    |                             |                 | DAC7654YCR      | Tape and Reel, 1500       |

(1) For the most current specification and package information, see the Package Ordering Addendum at the end of this data sheet.

**ABSOLUTE MAXIMUM RATINGS**

over operating free-air temperature range unless otherwise noted(1)

|  | DAC7654                       | UNIT |
|--|-------------------------------|------|
| IOV <sub>DD</sub> , V <sub>CC</sub> and V <sub>DD</sub> to V <sub>SS</sub> | -0.3 to 11                    | V    |
| IOV <sub>DD</sub> , V <sub>CC</sub> and V <sub>DD</sub> to GND             | -0.3 to 5.5                   | V    |
| Digital Input Voltage to GND   | -0.3 to V <sub>DD</sub> + 0.3 | V    |
| Digital Output Voltage to GND  | -0.3 to V <sub>DD</sub> + 0.3 | V    |
| ESD-CDM  | 200                           | V    |
| Maximum Junction Temperature   | +150                          | °C   |
| Operating Temperature Range  | -40 to +85                    | °C   |
| Storage Temperature Range  | -65 to +125                   | °C   |
| Lead Temperature (soldering, 10s)  | +300                          | °C   |

(1) Stresses above those listed under Absolute Maximum Ratings may cause permanent damage to the device. Exposure to absolute maximum conditions for extended periods may degrade device reliability. These are stress ratings only, and functional operation of the device at these or any other conditions beyond those specified is not implied.



This integrated circuit can be damaged by ESD. Texas Instruments recommends that all integrated circuits be handled with appropriate precautions. Failure to observe

proper handling and installation procedures can cause damage.

ESD damage can range from subtle performance degradation to complete device failure. Precision integrated circuits may be more susceptible to damage because very small parametric changes could cause the device not to meet its published specifications.

**ELECTRICAL CHARACTERISTICS:  $V_{SS} = 0V$** 

 All specifications at  $T_A = T_{MIN}$  to  $T_{MAX}$ ,  $IOV_{DD} = V_{DD} = V_{CC} = +5V$ , and  $V_{SS} = 0V$ , unless otherwise noted.

| PARAMETER                            | TEST CONDITIONS                  | DAC7654Y              |            |       | DAC7654YB |     |       | DAC7654YC |     |     | UNIT   |
|--------------------------------------|----------------------------------|-----------------------|------------|-------|-----------|-----|-------|-----------|-----|-----|--------|
|                                      |                                  | MIN                   | TYP        | MAX   | MIN       | TYP | MAX   | MIN       | TYP | MAX |        |
| <b>Accuracy</b>                      |                                  |                       |            |       |           |     |       |           |     |     |        |
| Linearity error                      |                                  |                       | ±3         | ±4    |           | ±2  | ±3    |           | *   | *   | LSB    |
| Linearity match                      |                                  |                       | ±4         |       |           | ±2  |       |           | *   |     | LSB    |
| Differential linearity error         |                                  |                       | ±2         | ±3    |           | ±1  | ±2    | -1        |     | +2  | LSB    |
| Monotonicity, $T_{MIN}$ to $T_{MAX}$ |                                  | 14                    |            |       | 15        |     |       | 16        |     |     | Bit    |
| Unipolar zero error                  |                                  |                       | ±1         | ±5    |           | *   | *     |           | *   | *   | mV     |
| Unipolar zero error drift            |                                  |                       | 5          | 10    |           | *   | *     |           | *   | *   | ppm/°C |
| Full-scale error                     |                                  |                       | ±6         | ±20   |           | ±4  | ±12.5 |           | *   | *   | mV     |
| Full-scale error drift               |                                  |                       | 7          | 15    |           | *   | *     |           | *   | *   | ppm/°C |
| Unipolar zero matching               | Channel-to-channel matching      |                       | ±3         | ±7    |           | ±2  | ±5    |           | *   | *   | mV     |
| Full-Scale matching                  | Channel-to-channel matching      |                       | ±4         | ±10   |           | ±2  | ±8    |           | *   | *   | mV     |
| Power-supply rejection ratio (PSRR)  | At full-scale                    |                       | 10         | 100   |           | *   | *     |           | *   | *   | ppm/V  |
| <b>Analog Output</b>                 |                                  |                       |            |       |           |     |       |           |     |     |        |
| Voltage output                       | $R_L = 10k\Omega$                | 0                     |            | 2.5   | *         |     | *     | *         |     | *   | V      |
| Output current                       |                                  | -1.25                 |            | +1.25 | *         |     | *     | *         |     | *   | mA     |
| Maximum load capacitance             | No oscillation                   |                       | 500        |       |           | *   |       | *         |     | *   | pF     |
| Short-circuit current                |                                  |                       | ±20        |       |           | *   |       | *         |     | *   | mA     |
| Short-circuit duration               | GND or $V_{CC}$                  |                       | Indefinite |       |           | *   |       | *         |     | *   |        |
| <b>Dynamic Performance</b>           |                                  |                       |            |       |           |     |       |           |     |     |        |
| Settling time                        | To ±0.003%, 2.5V output step     |                       | 12         | 15    |           | *   | *     | *         |     | *   | μs     |
| Channel-to-channel crosstalk         |                                  |                       | 0.5        |       |           | *   |       | *         |     | *   | LSB    |
| Digital feedthrough                  |                                  |                       | 2          |       |           | *   |       | *         |     | *   | nV-s   |
| Output noise voltage                 | $f = 10kHz$                      |                       | 130        |       |           | *   |       | *         |     | *   | nV/√Hz |
| DAC glitch                           | 7FFFh to 8000h or 8000h to 7FFFh |                       | 1          | 5     |           | *   | *     | *         |     | *   | nV-s   |
| <b>Digital Input</b>                 |                                  |                       |            |       |           |     |       |           |     |     |        |
| $V_{IH}$                             |                                  | $0.7 \times IOV_{DD}$ |            |       |           | *   |       | *         |     | *   | V      |
| $V_{IL}$                             |                                  | $0.3 \times IOV_{DD}$ |            |       |           |     | *     |           | *   | *   | V      |
| $I_{IH}$                             |                                  |                       |            | ±10   |           |     | *     |           | *   | *   | μA     |
| $I_{IL}$                             |                                  |                       |            | ±10   |           |     | *     |           | *   | *   | μA     |
| <b>Digital Output</b>                |                                  |                       |            |       |           |     |       |           |     |     |        |
| $V_{OH}$                             | $I_{OH} = -0.8mA, IOV_{DD} = 5V$ | 3.6                   | 4.5        |       | *         | *   | *     | *         | *   | *   | V      |
| $V_{OL}$                             | $I_{OL} = 1.6mA, IOV_{DD} = 5V$  |                       | 0.3        | 0.4   |           | *   | *     | *         | *   | *   | V      |
| $V_{OH}$                             | $I_{OH} = -0.4mA, IOV_{DD} = 3V$ | 2.4                   | 2.6        |       | *         | *   | *     | *         | *   | *   | V      |
| $V_{OL}$                             | $I_{OL} = 0.8mA, IOV_{DD} = 3V$  |                       | 0.3        | 0.4   |           | *   | *     | *         | *   | *   | V      |
| <b>Power Supply</b>                  |                                  |                       |            |       |           |     |       |           |     |     |        |
| $V_{DD}$                             |                                  | +4.75                 | +5.0       | +5.25 | *         | *   | *     | *         | *   | *   | V      |
| $IOV_{DD}$                           |                                  | +2.7                  | +5.0       | +5.25 | *         | *   | *     | *         | *   | *   | V      |
| $V_{CC}$                             |                                  | +4.75                 | +5.0       | +5.25 | *         | *   | *     | *         | *   | *   | V      |
| $V_{SS}$                             |                                  | 0                     | 0          | 0     | *         | *   | *     | *         | *   | *   | V      |
| $I_{CC}$                             |                                  |                       | 3.5        | 5     |           | *   | *     | *         | *   | *   | mA     |
| $I_{DD}$                             |                                  |                       | 50         |       |           | *   |       | *         |     | *   | μA     |
| $I(IOV_{DD})$                        |                                  |                       | 50         |       |           | *   |       | *         |     | *   | μA     |
| Power                                |                                  |                       | 18         | 25    |           | *   | *     | *         |     | *   | mW     |
| <b>Temperature Range</b>             |                                  |                       |            |       |           |     |       |           |     |     |        |
| Specified performance                |                                  | -40                   |            | +85   | *         |     | *     | *         |     | *   | °C     |

\* specifications same as the grade to the left

**ELECTRICAL CHARACTERISTICS:  $V_{SS} = -5V$**

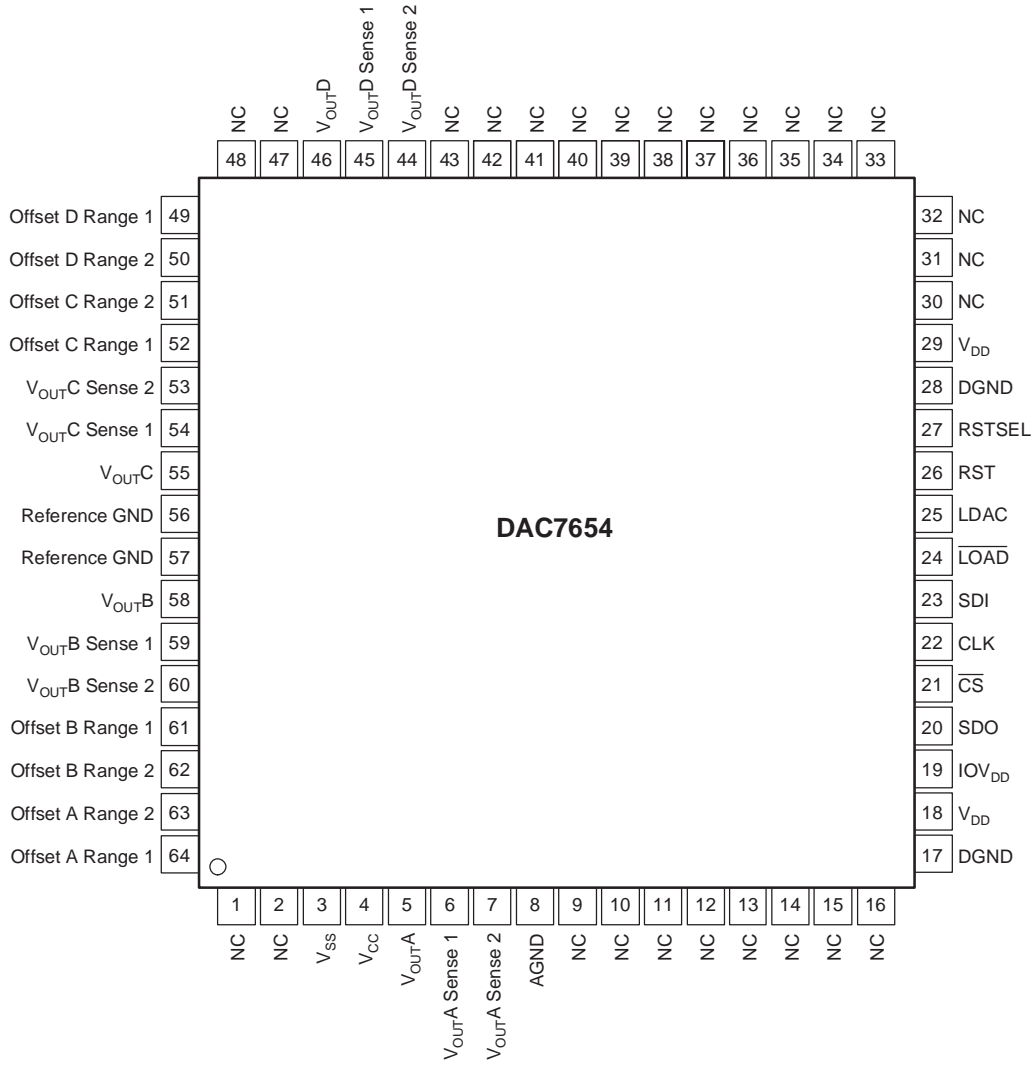
All specifications at  $T_A = T_{MIN}$  to  $T_{MAX}$ ,  $IOV_{DD} = V_{DD} = V_{CC} = +5V$ , and  $V_{SS} = -5V$ , unless otherwise noted.

| PARAMETER                            | TEST CONDITIONS                  | DAC7654Y |                       |       | DAC7654YB |     |       | DAC7654YC |     |     | UNIT |        |
|--------------------------------------|----------------------------------|----------|-----------------------|-------|-----------|-----|-------|-----------|-----|-----|------|--------|
|                                      |                                  | MIN      | TYP                   | MAX   | MIN       | TYP | MAX   | MIN       | TYP | MAX |      |        |
| <b>Accuracy</b>                      |                                  |          |                       |       |           |     |       |           |     |     |      |        |
| Linearity error                      |                                  |          | ±3                    | ±4    |           | ±2  | ±3    |           | *   | *   | LSB  |        |
| Linearity match                      |                                  |          | ±4                    |       |           | ±2  |       |           | *   |     | LSB  |        |
| Differential linearity error         |                                  |          | ±2                    | ±3    |           | ±1  | ±2    |           | -1  |     | +2   | LSB    |
| Monotonicity, $T_{MIN}$ to $T_{MAX}$ |                                  |          | 14                    |       |           | 15  |       |           | 16  |     |      | Bit    |
| Bipolar zero error                   |                                  |          | ±1                    | ±5    |           | *   | *     |           | *   | *   |      | mV     |
| Bipolar zero error drift             |                                  |          | 5                     | 10    |           | *   | *     |           | *   | *   |      | ppm/°C |
| Full-scale error                     |                                  |          | ±6                    | ±20   |           | ±4  | ±12.5 |           | *   | *   |      | mV     |
| Full-scale error drift               |                                  |          | 7                     | 15    |           | *   | *     |           | *   | *   |      | ppm/°C |
| Bipolar zero matching                | Channel-to-channel matching      |          | ±3                    | ±7    |           | ±2  | ±5    |           | *   | *   |      | mV     |
| Full-Scale matching                  | Channel-to-channel matching      |          | ±4                    | ±10   |           | ±2  | ±8    |           | *   | *   |      | mV     |
| Power-supply rejection ratio (PSRR)  | At full-scale                    |          | 10                    | 100   |           | *   | *     |           | *   | *   |      | ppm/V  |
| <b>Analog Output</b>                 |                                  |          |                       |       |           |     |       |           |     |     |      |        |
| Voltage output                       | $R_L = 10k\Omega$                |          | -2.5                  | +2.5  |           | *   | *     |           | *   | *   |      | V      |
| Output current                       |                                  |          | -1.25                 | +1.25 |           | *   | *     |           | *   | *   |      | mA     |
| Maximum load capacitance             | No oscillation                   |          | 500                   |       |           | *   |       |           | *   |     |      | pF     |
| Short-circuit current                |                                  |          | -15, +30              |       |           | *   |       |           | *   |     |      | mA     |
| Short-circuit duration               | GND or $V_{CC}$ or $V_{SS}$      |          | Indefinite            |       |           | *   |       |           | *   |     |      |        |
| <b>Dynamic Performance</b>           |                                  |          |                       |       |           |     |       |           |     |     |      |        |
| Settling time                        | To ±0.003%, 5V output step       |          | 12                    | 15    |           | *   | *     |           | *   | *   |      | µs     |
| Channel-to-channel crosstalk         |                                  |          | 0.5                   |       |           | *   |       |           | *   |     |      | LSB    |
| Digital feedthrough                  |                                  |          | 2                     |       |           | *   |       |           | *   |     |      | nV-s   |
| Output noise voltage                 | f = 10kHz                        |          | 200                   |       |           | *   |       |           | *   |     |      | nV/√Hz |
| DAC glitch                           | 7FFFh to 8000h or 8000h to 7FFFh |          | 2                     | 7     |           | *   | *     |           | *   | *   |      | nV-s   |
| <b>Digital Input</b>                 |                                  |          |                       |       |           |     |       |           |     |     |      |        |
| $V_{IH}$                             |                                  |          | $0.7 \times IOV_{DD}$ |       |           |     | *     |           | *   |     |      | V      |
| $V_{IL}$                             |                                  |          | $0.3 \times IOV_{DD}$ |       |           |     |       | *         |     | *   |      | V      |
| $I_{IH}$                             |                                  |          |                       | ±10   |           |     | *     |           | *   |     |      | µA     |
| $I_{IL}$                             |                                  |          |                       | ±10   |           |     | *     |           | *   |     |      | µA     |
| <b>Digital Output</b>                |                                  |          |                       |       |           |     |       |           |     |     |      |        |
| $V_{OH}$                             | $I_{OH} = -0.8mA, IOV_{DD} = 5V$ |          | 3.6                   | 4.5   |           | *   | *     |           | *   | *   |      | V      |
| $V_{OL}$                             | $I_{OL} = 1.6mA, IOV_{DD} = 5V$  |          |                       | 0.3   | 0.4       |     | *     | *         |     | *   | *    | V      |
| $V_{OH}$                             | $I_{OH} = -0.4mA, IOV_{DD} = 3V$ |          | 2.4                   | 2.6   |           | *   | *     |           | *   | *   |      | V      |
| $V_{OL}$                             | $I_{OL} = 0.8mA, IOV_{DD} = 3V$  |          |                       | 0.3   | 0.4       |     | *     | *         |     | *   | *    | V      |
| <b>Power Supply</b>                  |                                  |          |                       |       |           |     |       |           |     |     |      |        |
| $V_{DD}$                             |                                  |          | +4.75                 | +5.0  | +5.25     |     | *     | *         | *   | *   | *    | V      |
| $IOV_{DD}$                           |                                  |          | +2.7                  | +5.0  | +5.25     |     | *     | *         | *   | *   | *    | V      |
| $V_{CC}$                             |                                  |          | +4.75                 | +5.0  | +5.25     |     | *     | *         | *   | *   | *    | V      |
| $V_{SS}$                             |                                  |          | -5.25                 | -5.0  | -4.75     |     | *     | *         | *   | *   | *    | V      |
| $I_{CC}$                             |                                  |          |                       | 4     | 5.5       |     | *     | *         |     | *   | *    | mA     |
| $I_{DD}$                             |                                  |          |                       | 50    |           |     | *     |           |     | *   |      | µA     |
| $I(IOV_{DD})$                        |                                  |          |                       | 50    |           |     | *     |           |     | *   |      | µA     |
| $I_{SS}$                             |                                  |          | -3.5                  | -2.0  |           |     | *     | *         |     | *   | *    | mA     |
| Power                                |                                  |          |                       | 30    | 45        |     | *     | *         |     | *   |      | mW     |
| <b>Temperature Range</b>             |                                  |          |                       |       |           |     |       |           |     |     |      |        |
| Specified performance                |                                  |          | -40                   |       | +85       |     | *     | *         |     | *   | *    | °C     |

\* specifications same as the grade to the left

**PIN ASSIGNMENTS**

**LQFP PACKAGE  
(TOP VIEW)**



**Terminal Functions**

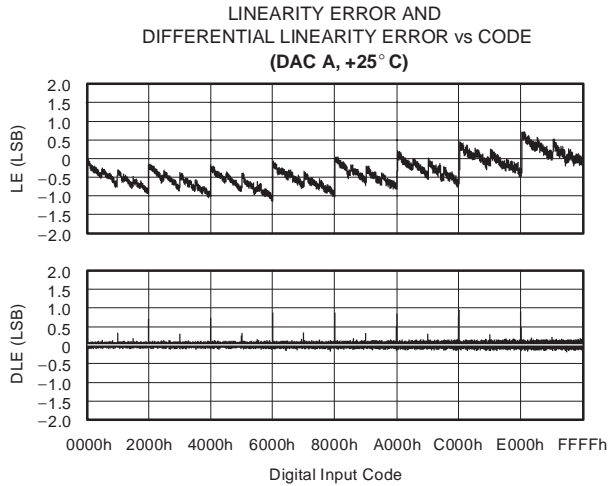
| PIN | NAME                         | DESCRIPTION   |
|-----|------------------------------|---|
| 1   | NC                           | No Connection   |
| 2   | NC                           | No Connection   |
| 3   | V <sub>SS</sub>              | Analog –5V power supply or 0V single supply   |
| 4   | V <sub>CC</sub>              | Analog +5V power supply   |
| 5   | V <sub>OUTA</sub>            | DAC A output voltage  |
| 6   | V <sub>OUTA</sub><br>Sense 1 | Connect to V <sub>OUTA</sub> for unipolar mode  |
| 7   | V <sub>OUTA</sub><br>Sense 2 | Connect to V <sub>OUTA</sub> for bipolar mode   |
| 8   | AGND                         | Analog ground   |
| 9   | NC                           | No connection   |
| 10  | NC                           | No connection   |
| 11  | NC                           | No connection   |
| 12  | NC                           | No connection   |
| 13  | NC                           | No connection   |
| 14  | NC                           | No connection   |
| 15  | NC                           | No connection   |
| 16  | NC                           | No connection   |
| 17  | DGND                         | Digital ground  |
| 18  | V <sub>DD</sub>              | Digital +5V power supply  |
| 19  | IOV <sub>DD</sub>            | Interface power supply  |
| 20  | SDO                          | Serial data output  |
| 21  | CS                           | Chip select, active low   |
| 22  | CLK                          | Data clock input  |
| 23  | SDI                          | Serial data input   |
| 24  | LOAD                         | DAC input register load control, active low   |
| 25  | LDAC                         | DAC register load control, rising edge triggered  |
| 26  | RST                          | Reset, rising edge triggered. Depending on the state of RSTSEL, the DAC registers are set to either mid-scale or zero.  |
| 27  | RSTSEL                       | Reset select. Determines the action of RST. If high, an RST command sets the DAC registers to mid-scale (8000h). If low, an RST command sets the DAC registers to zero (0000h). |
| 28  | DGND                         | Digital ground  |
| 29  | V <sub>DD</sub>              | Digital +5V power supply  |
| 30  | NC                           | No connection   |
| 31  | NC                           | No connection   |
| 32  | NC                           | No connection   |
| 33  | NC                           | No connection   |
| 34  | NC                           | No connection   |
| 35  | NC                           | No connection   |

| PIN | NAME                         | DESCRIPTION                                    |
|-----|------------------------------|--|
| 36  | NC                           | No connection                                  |
| 37  | NC                           | No connection                                  |
| 38  | NC                           | No connection                                  |
| 39  | NC                           | No connection                                  |
| 40  | NC                           | No connection                                  |
| 41  | NC                           | No connection                                  |
| 42  | NC                           | No connection                                  |
| 43  | NC                           | No connection                                  |
| 44  | V <sub>OUTD</sub><br>Sense 2 | Connect to V <sub>OUTD</sub> for bipolar mode  |
| 45  | V <sub>OUTD</sub><br>Sense 1 | Connect to V <sub>OUTD</sub> for unipolar mode |
| 46  | V <sub>OUTD</sub>            | DAC D output                                   |
| 47  | NC                           | No connection                                  |
| 48  | NC                           | No connection                                  |
| 49  | Offset D<br>Range 1          | Connect to Offset D Range 2 for unipolar mode  |
| 50  | Offset D<br>Range 2          | Connect to Offset D Range 1 for unipolar mode  |
| 51  | Offset C<br>Range 2          | Connect to Offset C Range 1 for unipolar mode  |
| 52  | Offset C<br>Range 1          | Connect to Offset C Range 2 for unipolar mode  |
| 53  | V <sub>OUTC</sub><br>Sense 2 | Connect to V <sub>OUTC</sub> for bipolar mode  |
| 54  | V <sub>OUTC</sub><br>Sense 1 | Connect to V <sub>OUTC</sub> for unipolar mode |
| 55  | V <sub>OUTC</sub>            | DAC C output                                   |
| 56  | REF GND                      | Reference ground                               |
| 57  | REF GND                      | Reference ground                               |
| 58  | V <sub>OUTB</sub>            | DAC B output                                   |
| 59  | V <sub>OUTB</sub><br>Sense 1 | Connect to V <sub>OUTB</sub> for unipolar mode |
| 60  | V <sub>OUTB</sub><br>Sense 2 | Connect to V <sub>OUTB</sub> for bipolar mode  |
| 61  | Offset B<br>Range 1          | Connect to Offset B Range 2 for unipolar mode  |
| 62  | Offset B<br>Range 2          | Connect to Offset B Range 1 for unipolar mode  |
| 63  | Offset A<br>Range 2          | Connect to Offset A Range 1 for unipolar mode  |
| 64  | Offset A<br>Range 1          | Connect to Offset A Range 2 for unipolar mode  |

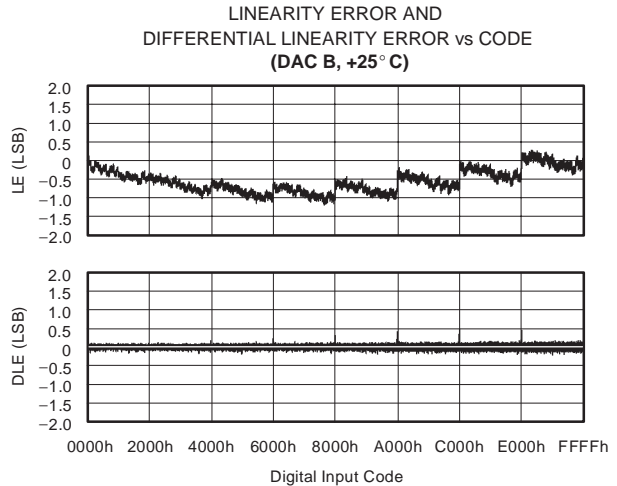
**TYPICAL CHARACTERISTICS:  $V_{SS} = 0V$**

All specifications at  $T_A = 25^\circ C$ ,  $IOV_{DD} = V_{DD} = V_{CC} = +5V$ ,  $V_{SS} = 0V$ , representative unit, unless otherwise noted.

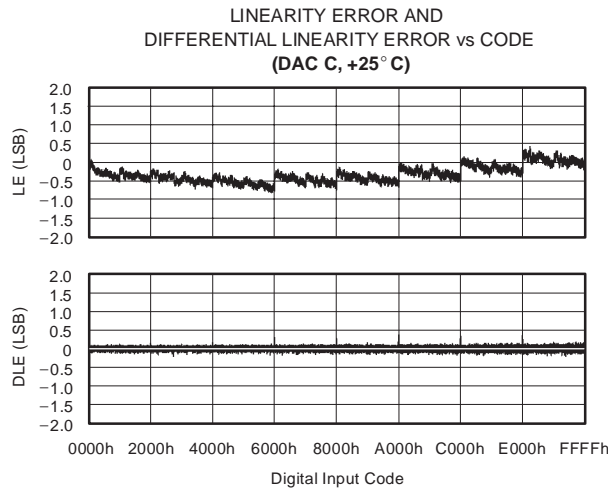
**+25°C**



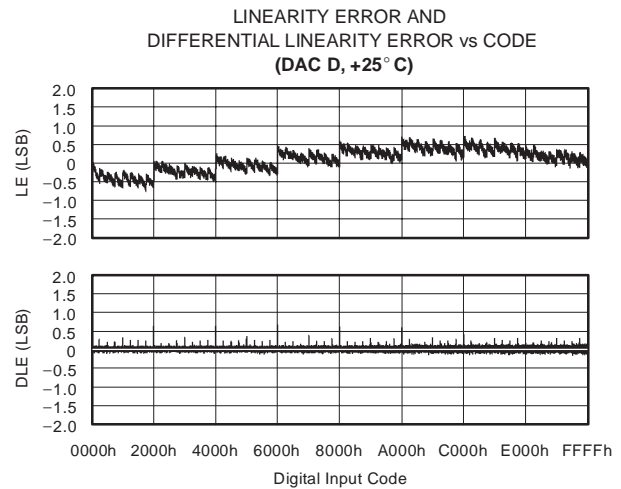
**Figure 1**



**Figure 2**



**Figure 3**

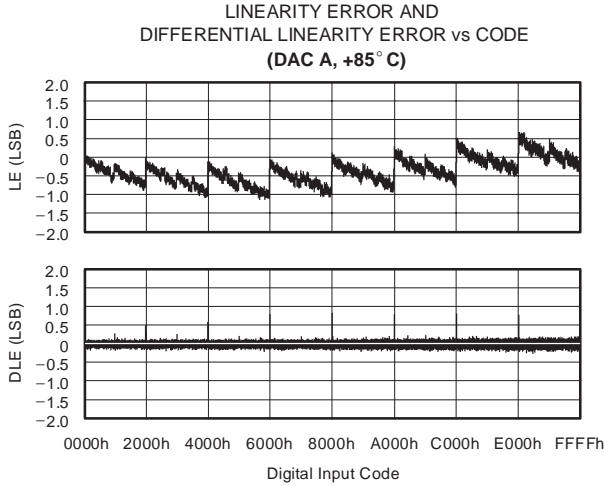


**Figure 4**

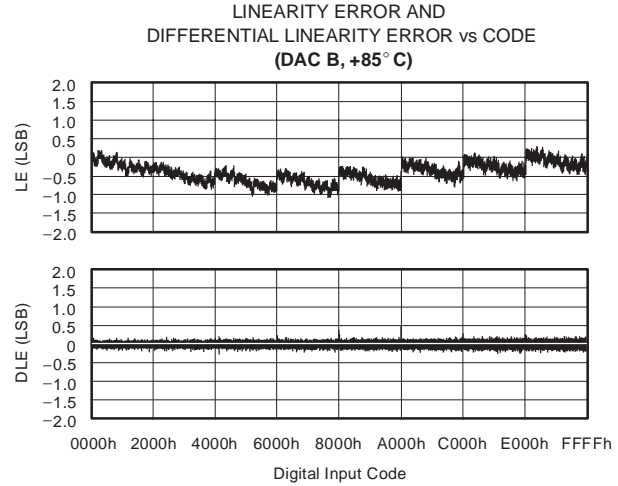
**TYPICAL CHARACTERISTICS:  $V_{SS} = 0V$  (continued)**

All specifications at  $T_A = 25^\circ C$ ,  $IOV_{DD} = V_{DD} = V_{CC} = +5V$ ,  $V_{SS} = 0V$ , representative unit, unless otherwise noted.

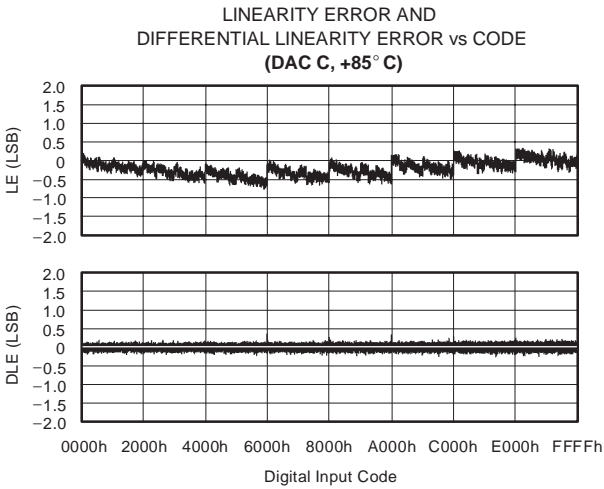
**+85°C**



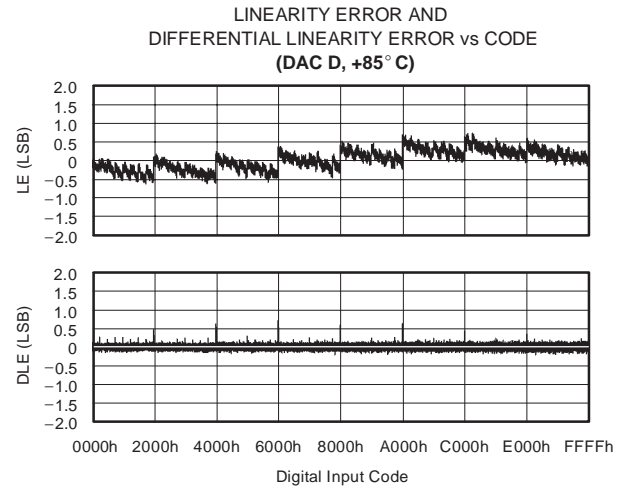
**Figure 5**



**Figure 6**



**Figure 7**



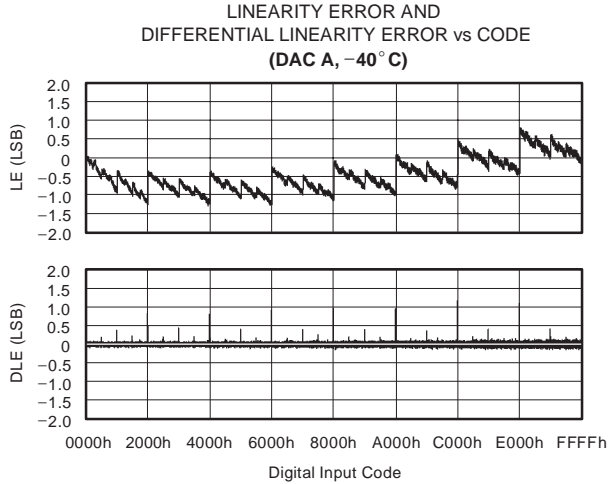
**Figure 8**



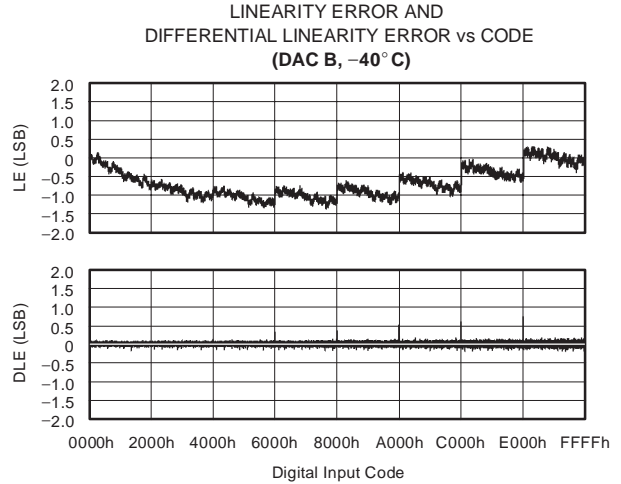
**TYPICAL CHARACTERISTICS:  $V_{SS} = 0V$  (continued)**

All specifications at  $T_A = 25^\circ C$ ,  $IOV_{DD} = V_{DD} = V_{CC} = +5V$ ,  $V_{SS} = 0V$ , representative unit, unless otherwise noted.

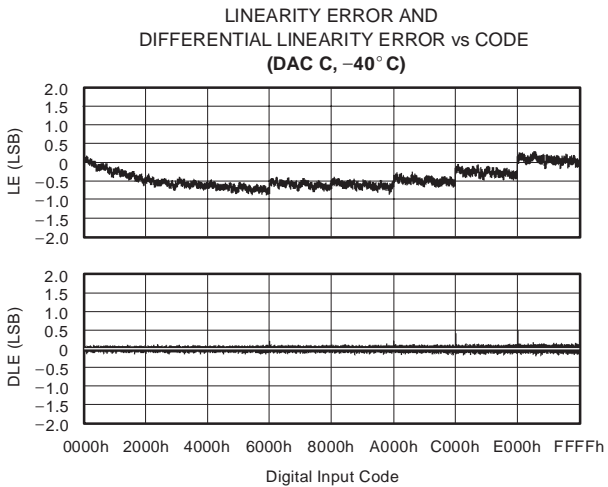
**-40°C**



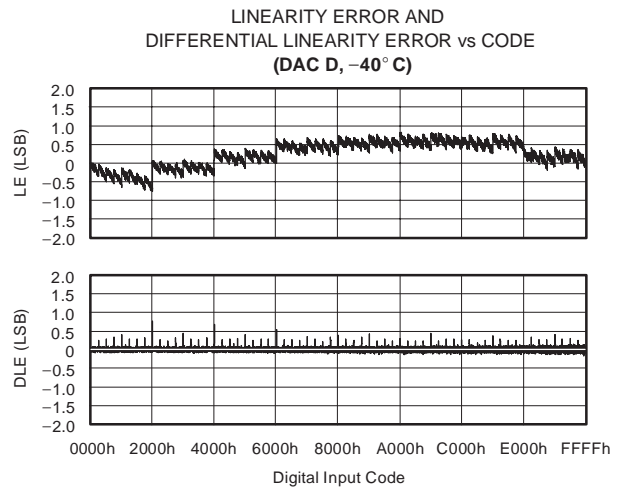
**Figure 9**



**Figure 10**



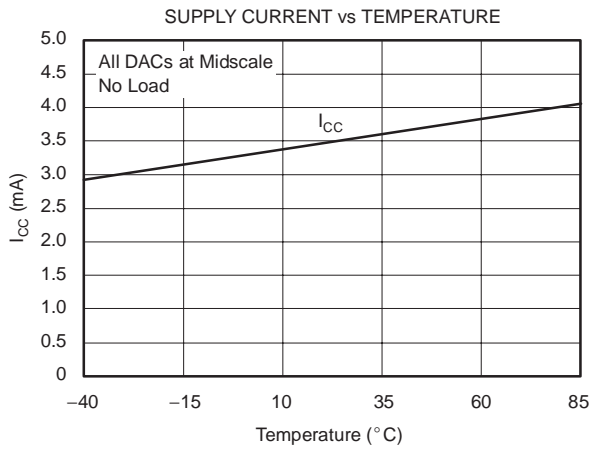
**Figure 11**



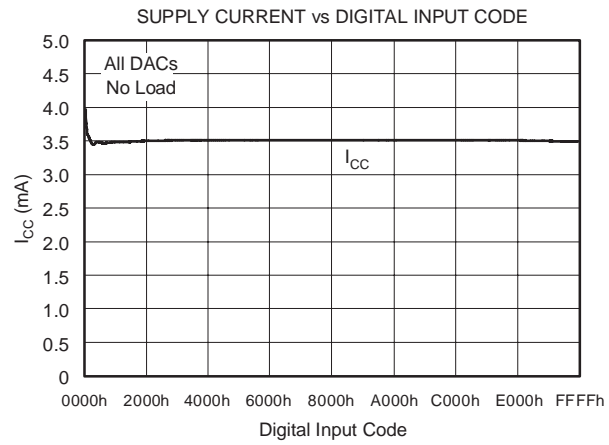
**Figure 12**

**TYPICAL CHARACTERISTICS:  $V_{SS} = 0V$  (continued)**

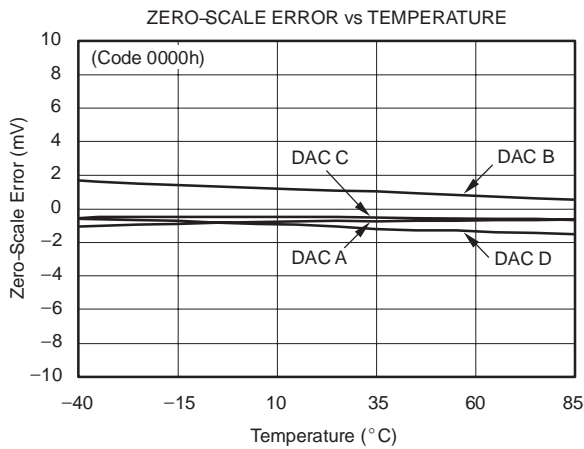
All specifications at  $T_A = 25^\circ C$ ,  $IOV_{DD} = V_{DD} = V_{CC} = +5V$ ,  $V_{SS} = 0V$ , representative unit, unless otherwise noted.



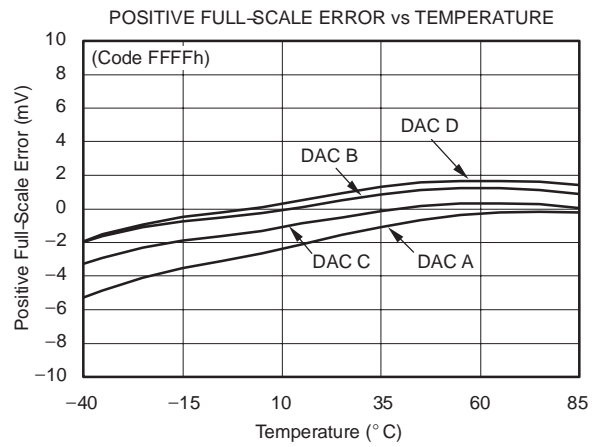
**Figure 13**



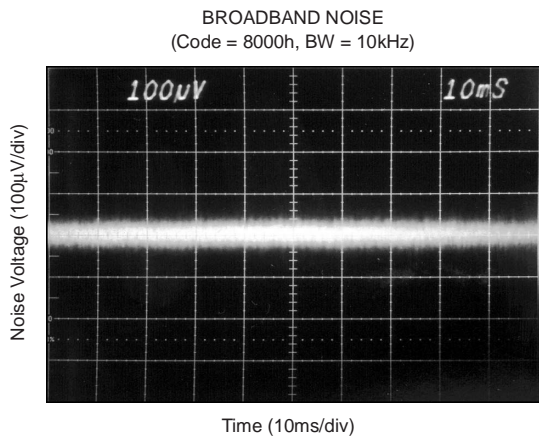
**Figure 14**



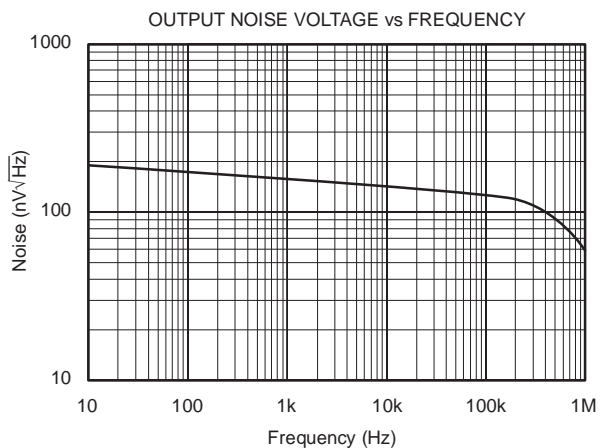
**Figure 15**



**Figure 16**



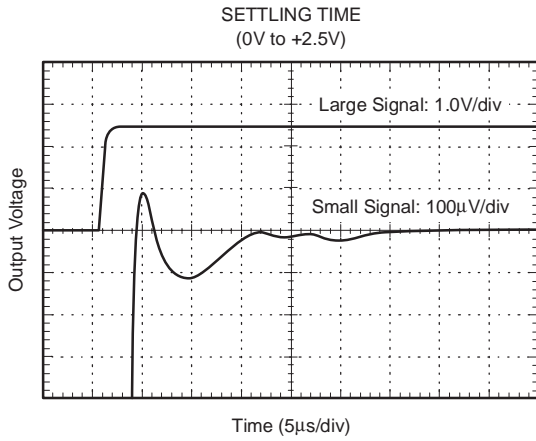
**Figure 17**



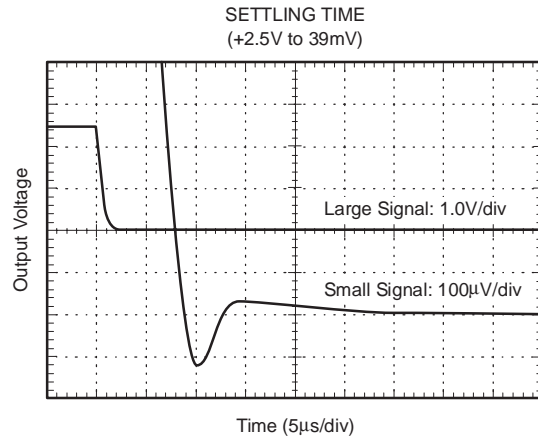
**Figure 18**

**TYPICAL CHARACTERISTICS:  $V_{SS} = 0V$  (continued)**

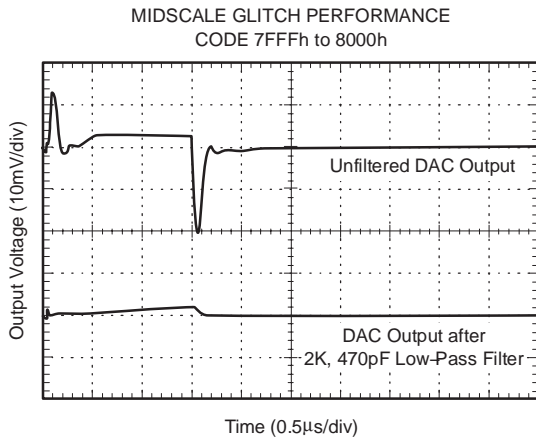
All specifications at  $T_A = 25^\circ C$ ,  $IOV_{DD} = V_{DD} = V_{CC} = +5V$ ,  $V_{SS} = 0V$ , representative unit, unless otherwise noted.



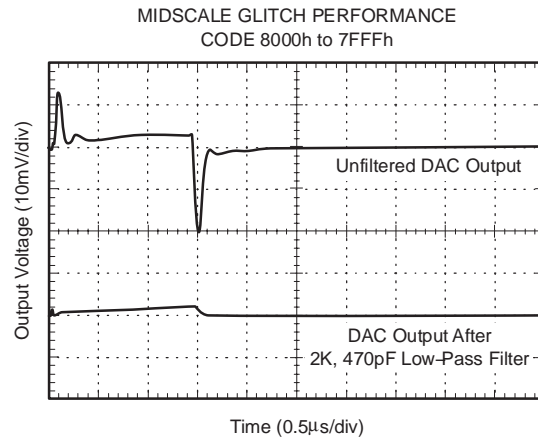
**Figure 19**



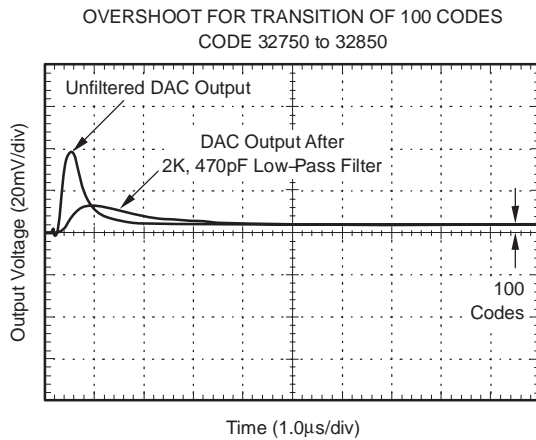
**Figure 20**



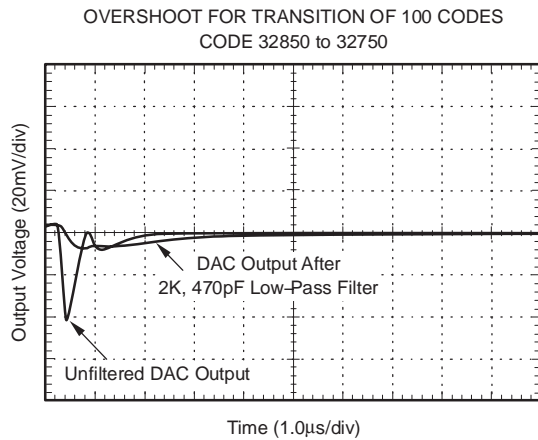
**Figure 21**



**Figure 22**



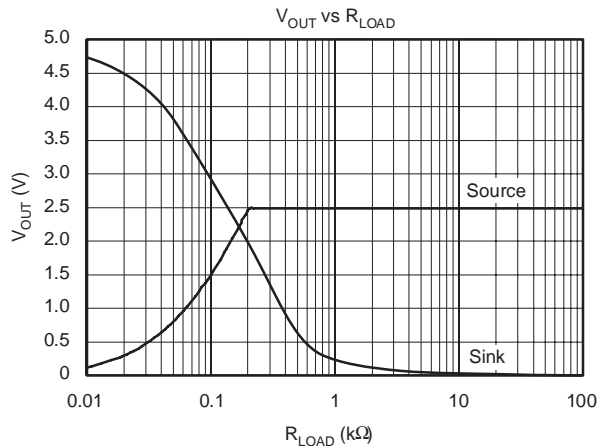
**Figure 23**



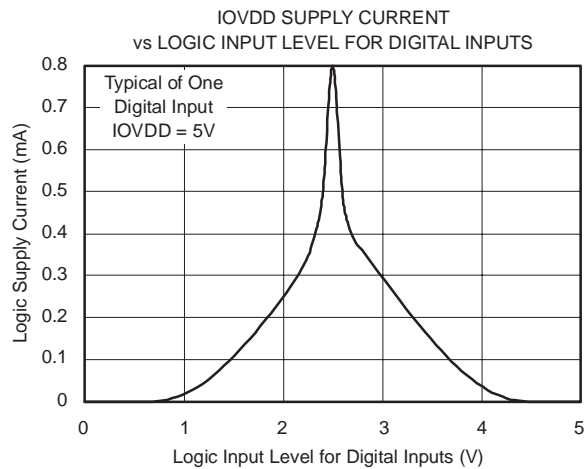
**Figure 24**

**TYPICAL CHARACTERISTICS:  $V_{SS} = 0V$  (continued)**

All specifications at  $T_A = 25^\circ C$ ,  $IOV_{DD} = V_{DD} = V_{CC} = +5V$ ,  $V_{SS} = 0V$ , representative unit, unless otherwise noted.



**Figure 25**

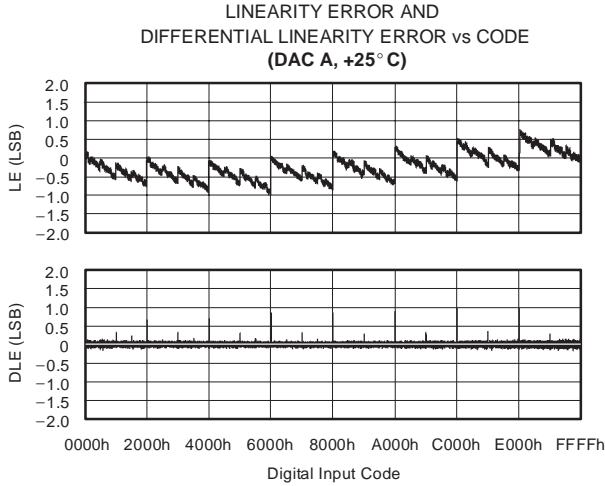


**Figure 26**

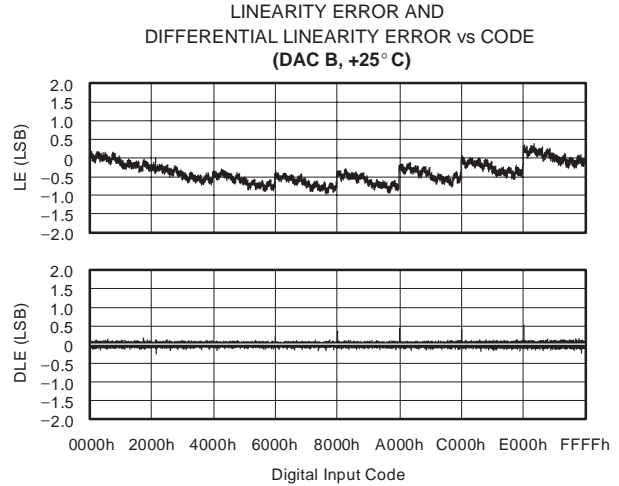
**TYPICAL CHARACTERISTICS:  $V_{SS} = -5V$**

All specifications at  $T_A = 25^\circ C$ ,  $IOV_{DD} = V_{DD} = V_{CC} = +5V$ ,  $V_{SS} = -5V$ , representative unit, unless otherwise noted.

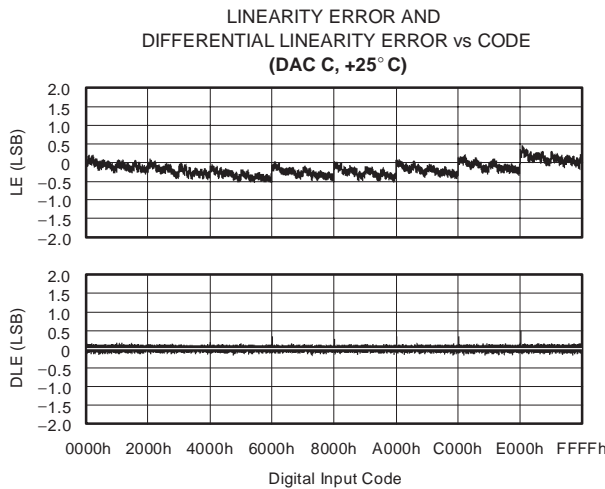
**+25°C**



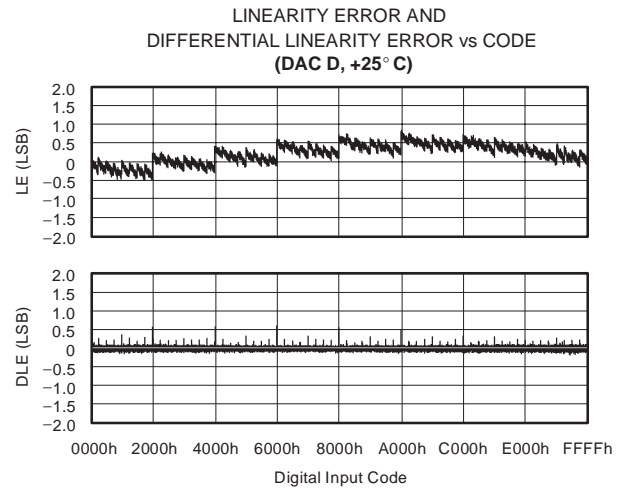
**Figure 27**



**Figure 28**



**Figure 29**

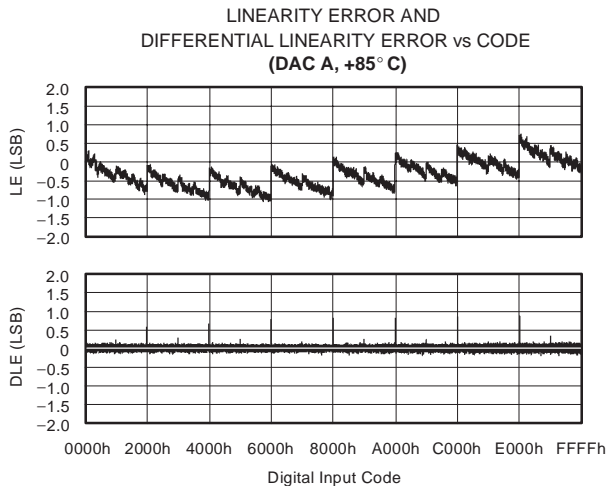


**Figure 30**

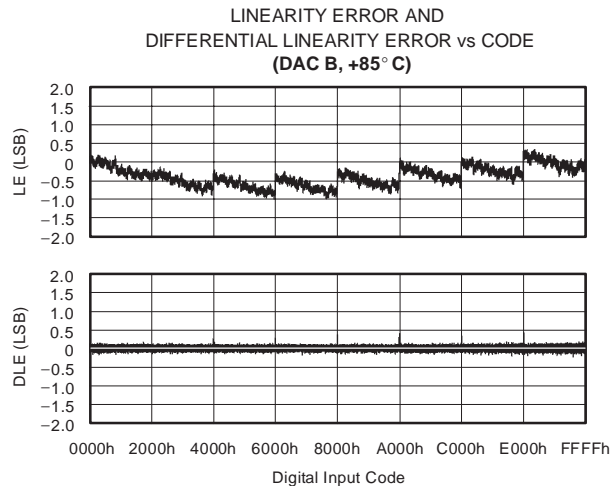
**TYPICAL CHARACTERISTICS:  $V_{SS} = -5V$  (continued)**

All specifications at  $T_A = 25^\circ C$ ,  $IOV_{DD} = V_{DD} = V_{CC} = +5V$ ,  $V_{SS} = -5V$ , representative unit, unless otherwise noted.

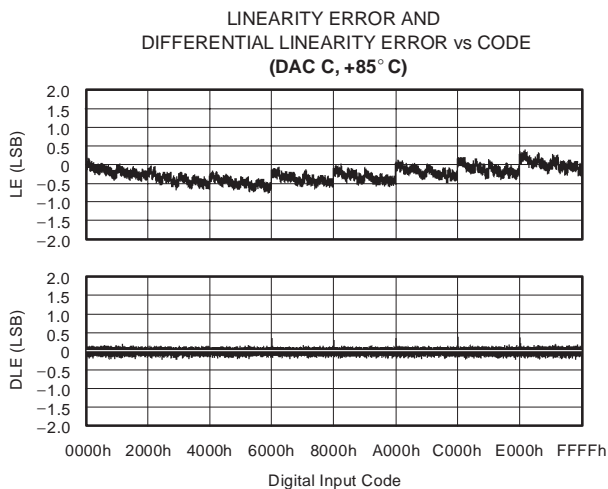
**+85°C**



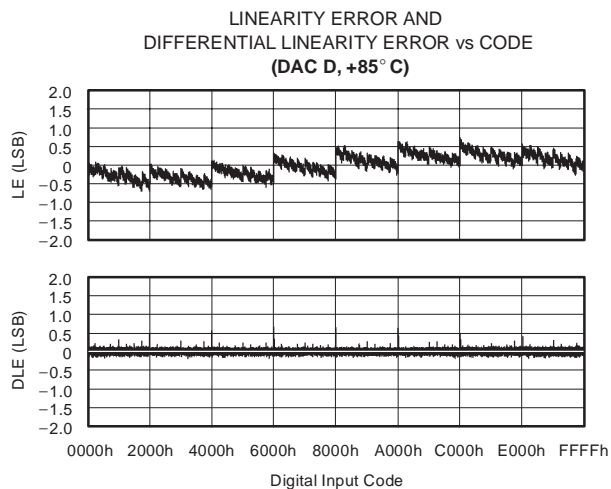
**Figure 31**



**Figure 32**



**Figure 33**

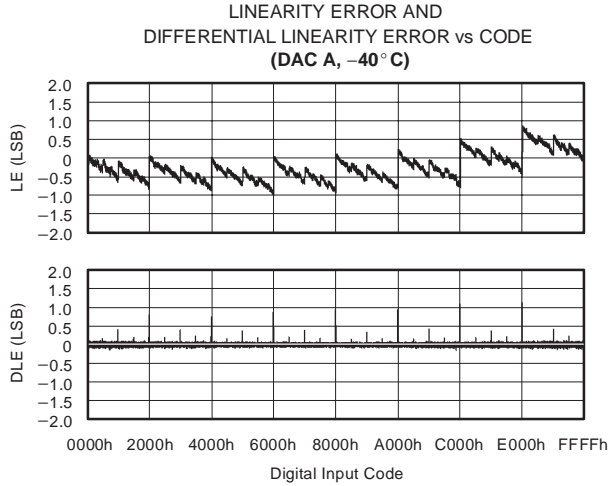


**Figure 34**

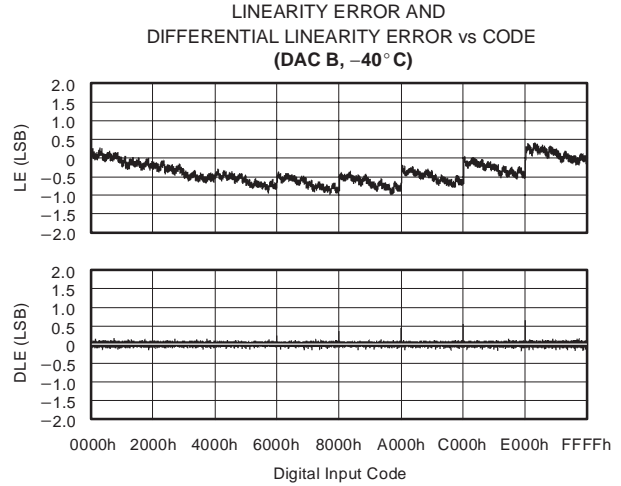
**TYPICAL CHARACTERISTICS:  $V_{SS} = -5V$  (continued)**

All specifications at  $T_A = 25^\circ C$ ,  $IOV_{DD} = V_{DD} = V_{CC} = +5V$ ,  $V_{SS} = -5V$ , representative unit, unless otherwise noted.

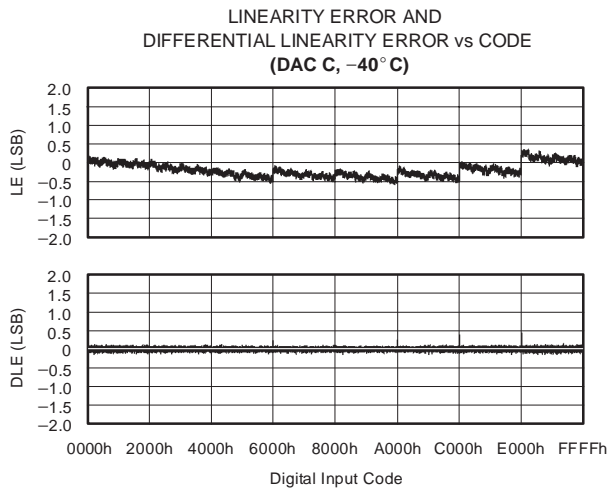
**-40°C**



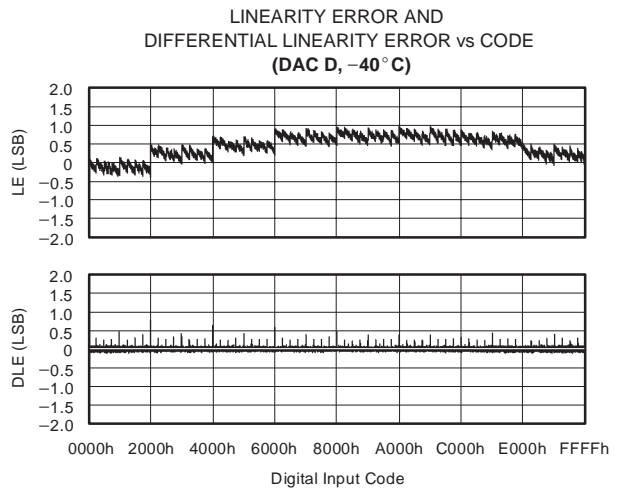
**Figure 35**



**Figure 36**



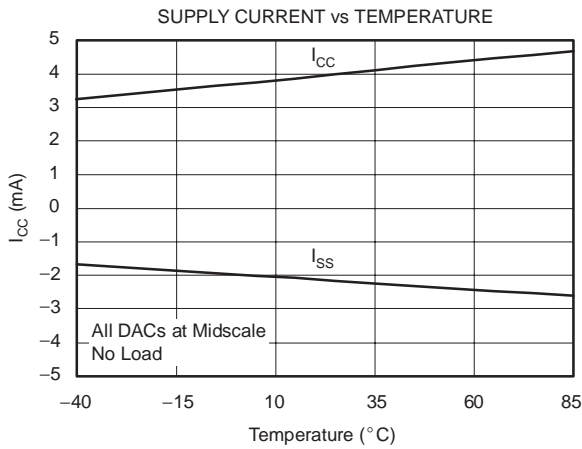
**Figure 37**



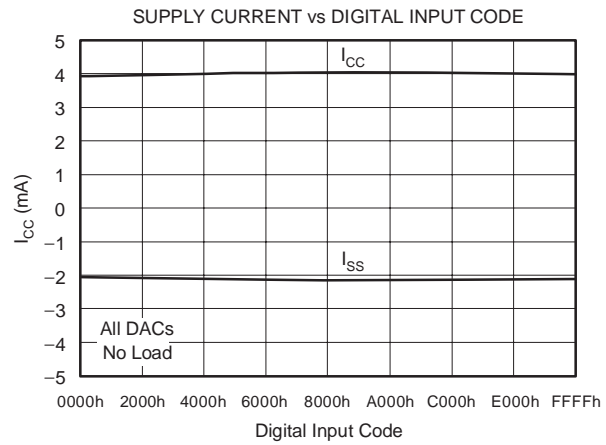
**Figure 38**

**TYPICAL CHARACTERISTICS:  $V_{SS} = -5V$  (continued)**

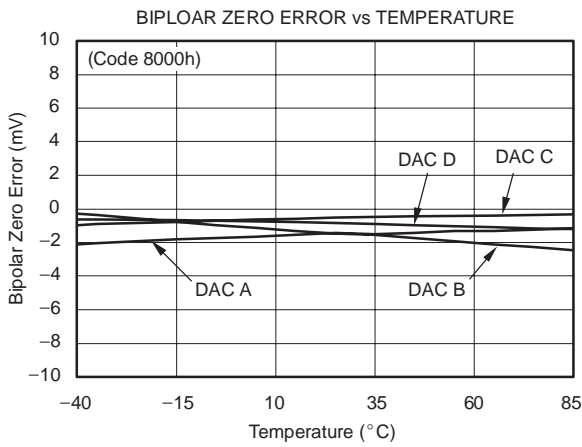
All specifications at  $T_A = 25^\circ C$ ,  $IOV_{DD} = V_{DD} = V_{CC} = +5V$ ,  $V_{SS} = -5V$ , representative unit, unless otherwise noted.



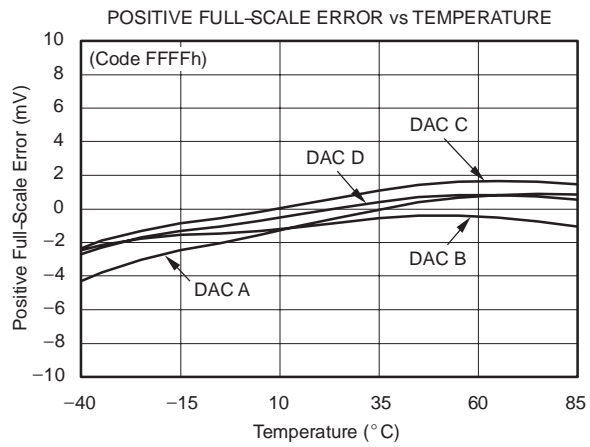
**Figure 39**



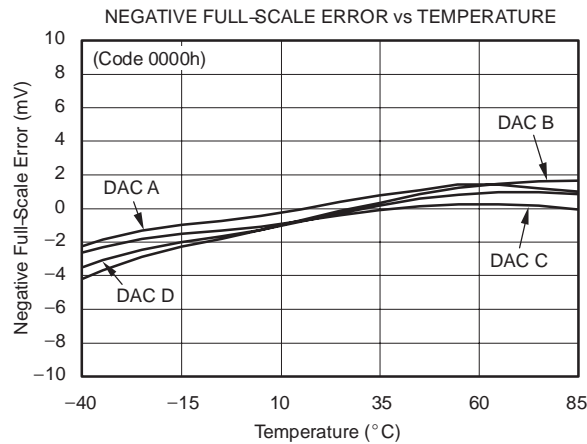
**Figure 40**



**Figure 41**



**Figure 42**

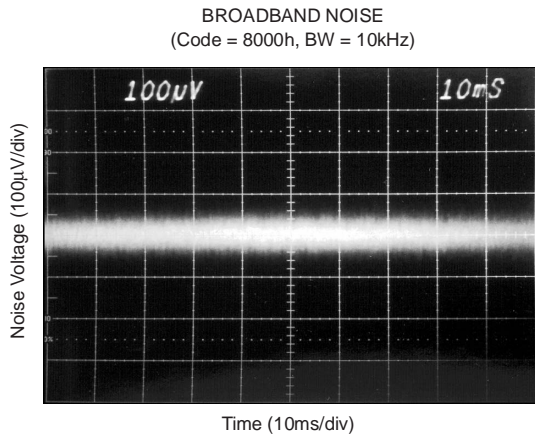


**Figure 43**

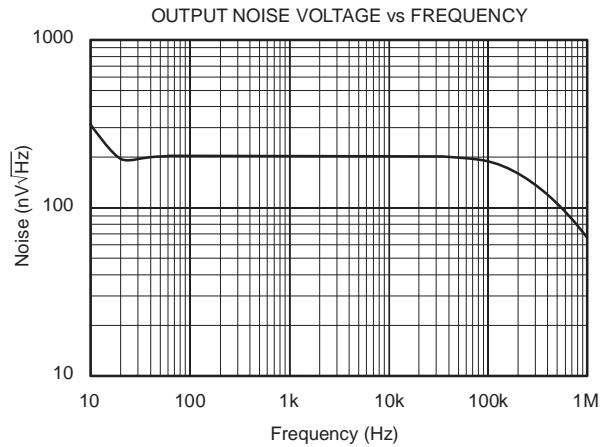


**TYPICAL CHARACTERISTICS:  $V_{SS} = -5V$  (continued)**

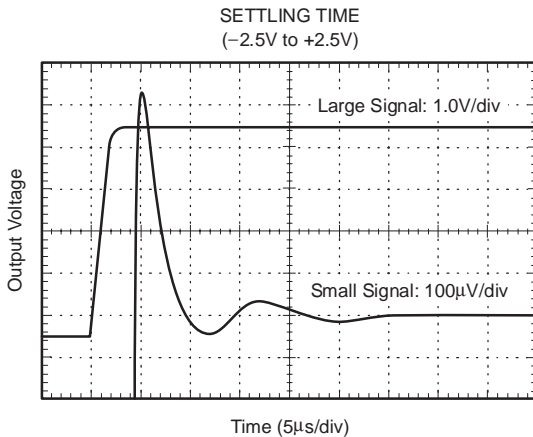
All specifications at  $T_A = 25^\circ C$ ,  $I_{O}V_{DD} = V_{DD} = V_{CC} = +5V$ ,  $V_{SS} = -5V$ , representative unit, unless otherwise noted.



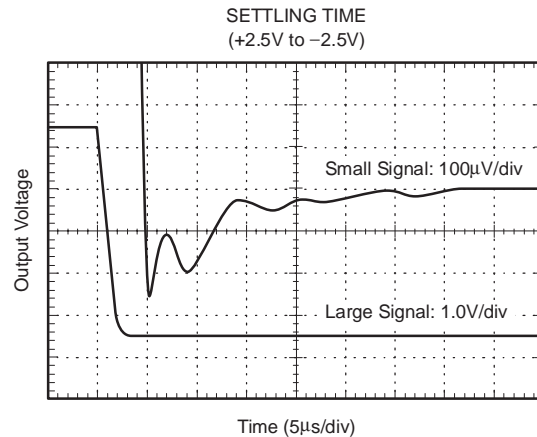
**Figure 44**



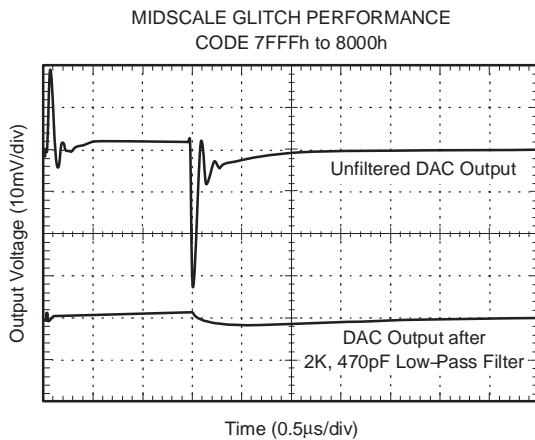
**Figure 45**



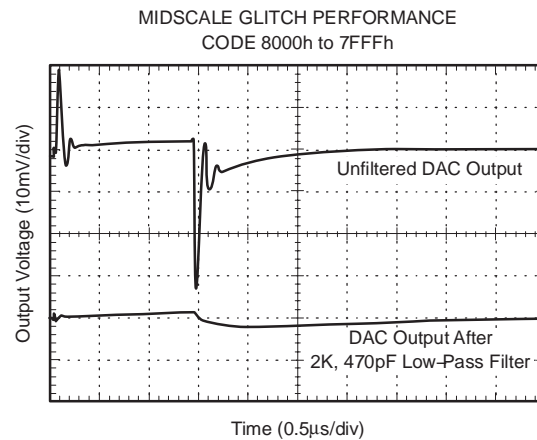
**Figure 46**



**Figure 47**



**Figure 48**

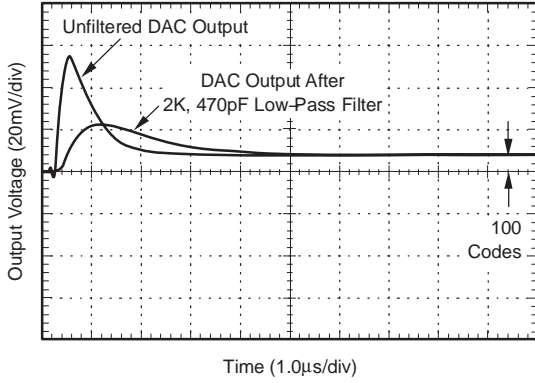


**Figure 49**

**TYPICAL CHARACTERISTICS:  $V_{SS} = -5V$  (continued)**

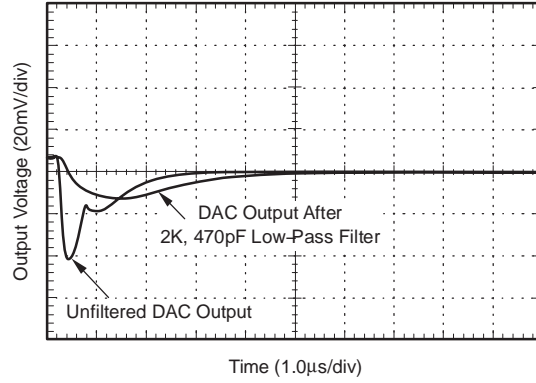
All specifications at  $T_A = 25^\circ C$ ,  $IOV_{DD} = V_{DD} = V_{CC} = +5V$ ,  $V_{SS} = -5V$ , representative unit, unless otherwise noted.

OVERSHOOT FOR TRANSITION OF 100 CODES  
CODE 32750 to 32850

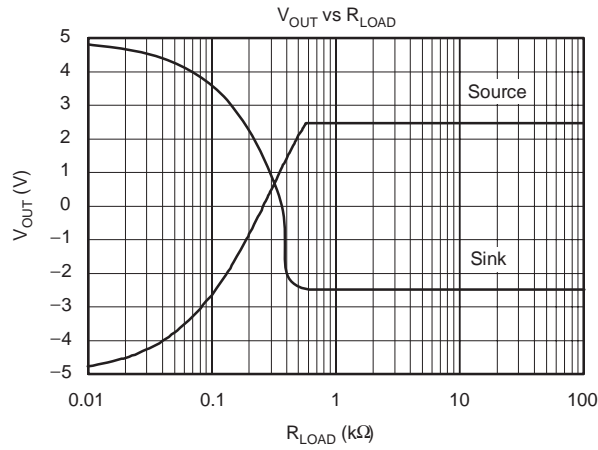


**Figure 50**

OVERSHOOT FOR TRANSITION OF 100 CODES  
CODE 32850 to 32750



**Figure 51**

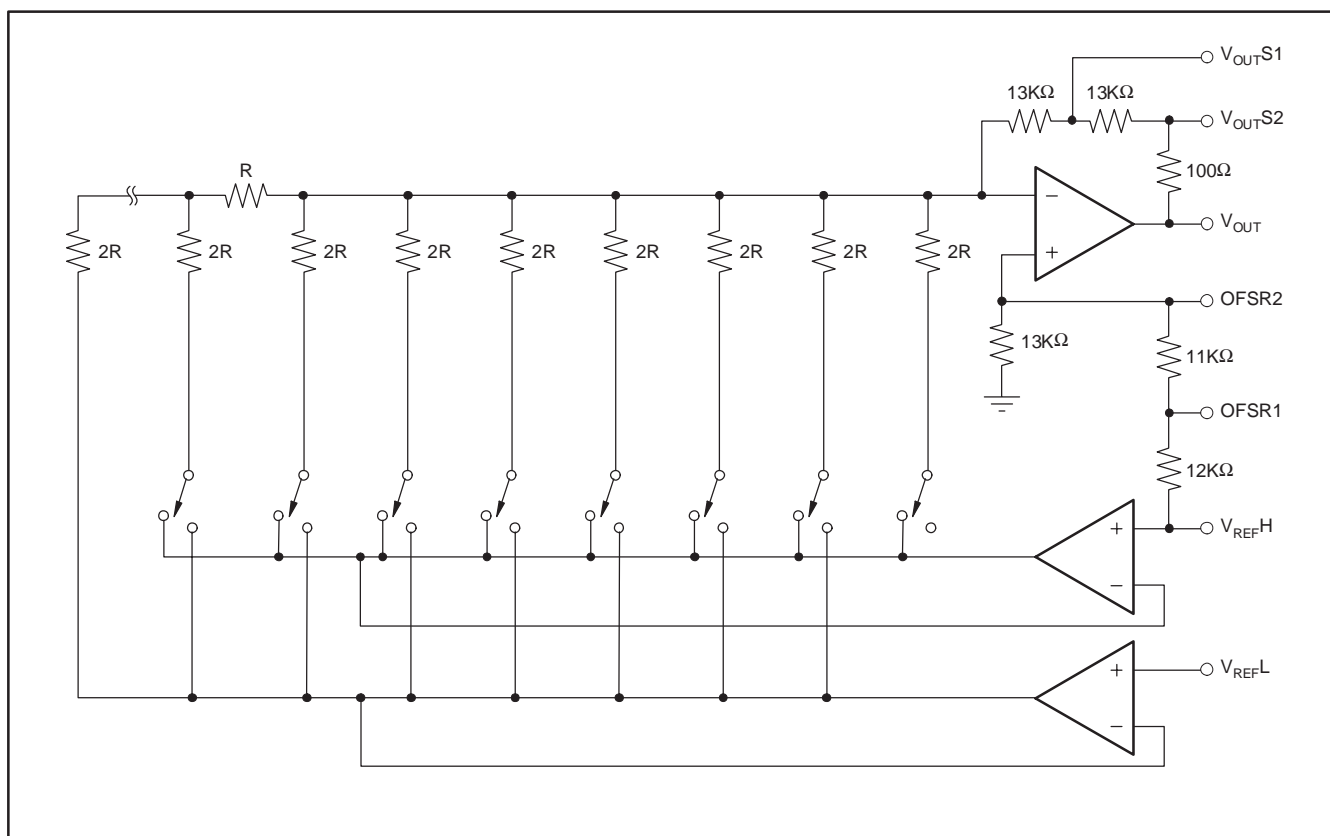


**Figure 52**

## THEORY OF OPERATION

The DAC7654 is a quad voltage output, 16-bit DAC. The architecture is an R–2R ladder configuration with the three most significant bits (MSBs) segmented, followed by an operational amplifier that serves as a buffer. Each DAC has its own R–2R ladder network, segmented MSBs, and output op amp, as shown in Figure 53. The minimum voltage output (zero-scale) and maximum voltage output (full-scale) are set by the internal voltage references and the resistors associated with the output operational amplifier.

The digital input is a 24-bit serial word that contains a 2-bit address code for selecting one of four DACs, a quick load bit, five unused bits, and the 16-bit DAC code (MSB first). The converters can be powered from either a single +5V supply or a dual  $\pm 5V$  supply. The device offers a reset function that immediately sets all DAC output voltages and DAC registers to mid-scale (code 8000h) or to zero-scale (code 0000h). See Figure 54 and Figure 55 for basic single- and dual-supply operation of the DAC7654.



**Figure 53. DAC7654 Architecture**

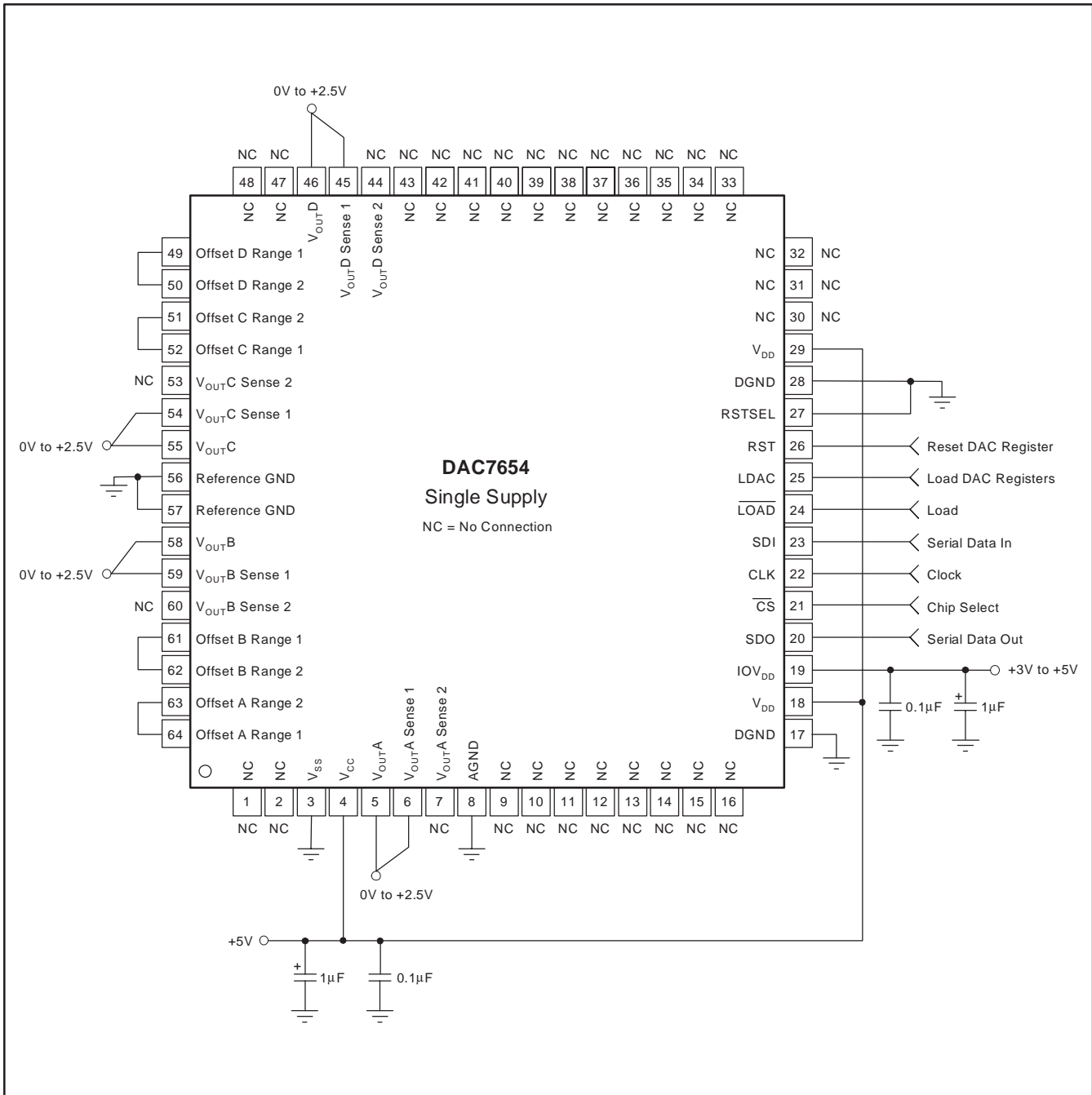
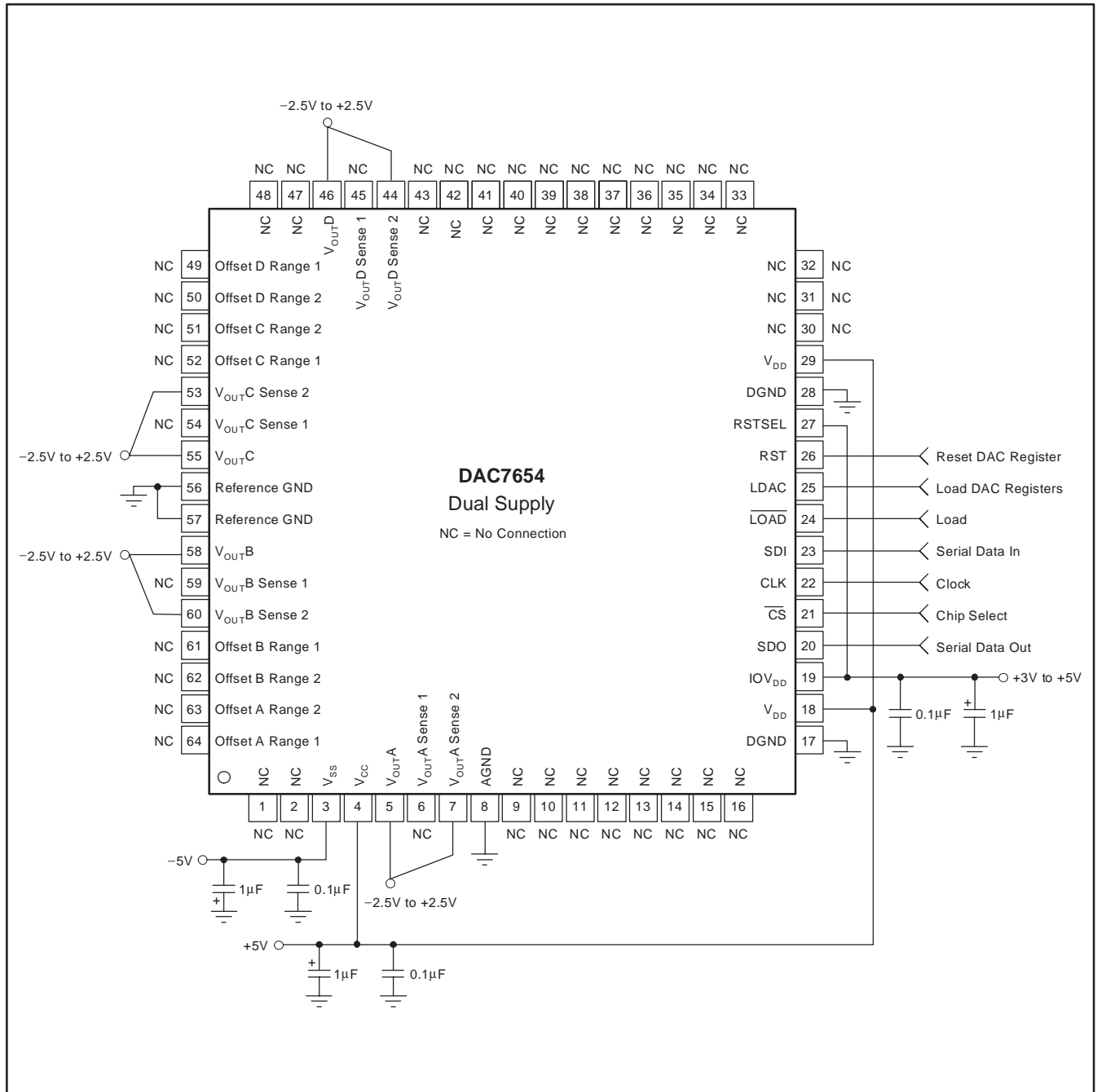


Figure 54. Basic Single-Supply Operation of the DAC7654



**Figure 55. Basic Dual-Supply Operation of the DAC7654**

**ANALOG OUTPUTS**

When  $V_{SS} = -5V$  (dual-supply operation), the output amplifier can swing to within 2.25V of the supply rails over a range of  $-40^{\circ}C$  to  $+85^{\circ}C$ . When  $V_{SS} = 0V$  (single-supply operation), and with  $R_{LOAD}$  also connected to ground, the output can swing to within 5mV of ground. Care must be taken when measuring the zero-scale error when  $V_{SS} = 0V$ . Since the output voltage cannot swing below ground, the output voltage may not change for the first few digital input codes (0000h, 0001h, 0002h, etc.) if the output amplifier has a negative offset.

Due to the high accuracy of these DACs, system design problems such as grounding and contact resistance are very important. A 16-bit converter with a 2.5V full-scale range has a 1LSB value of  $38\mu V$ . With a load current of 1mA, series wiring and connector resistance of only  $40m\Omega$  ( $R_{W2}$ ) will cause a voltage drop of  $40\mu V$ , as shown in Figure 56. To understand what this means in terms of system layout, the resistivity of a typical 1-ounce copper-clad printed circuit board is  $1/2 m\Omega$  per square. For a 1mA load, a 0.01-inch-wide printed circuit conductor 0.6 inches long will result in a voltage drop of  $30\mu V$ .

The DAC7654 offers a force and sense output configuration for the high open-loop gain output amplifier. This feature allows the loop around the output amplifier to be closed at the load (as shown in Figure 56), thus ensuring an accurate output voltage.

**DIGITAL INTERFACE**

Table 1 shows the basic control logic for the DAC7654. The interface consists of a signal data clock (CLK) input, serial data in (SDI), DAC input register load control signal (LOAD), and DAC register load control signal (LDAC). In addition, a chip select ( $\overline{CS}$ ) input is available to enable serial communication when there are multiple serial devices. An asynchronous reset (RST) input, by the rising edge, is provided to simplify startup conditions, periodic resets, or emergency resets to a known state, depending on the status of the reset select (RSTSEL) signal.

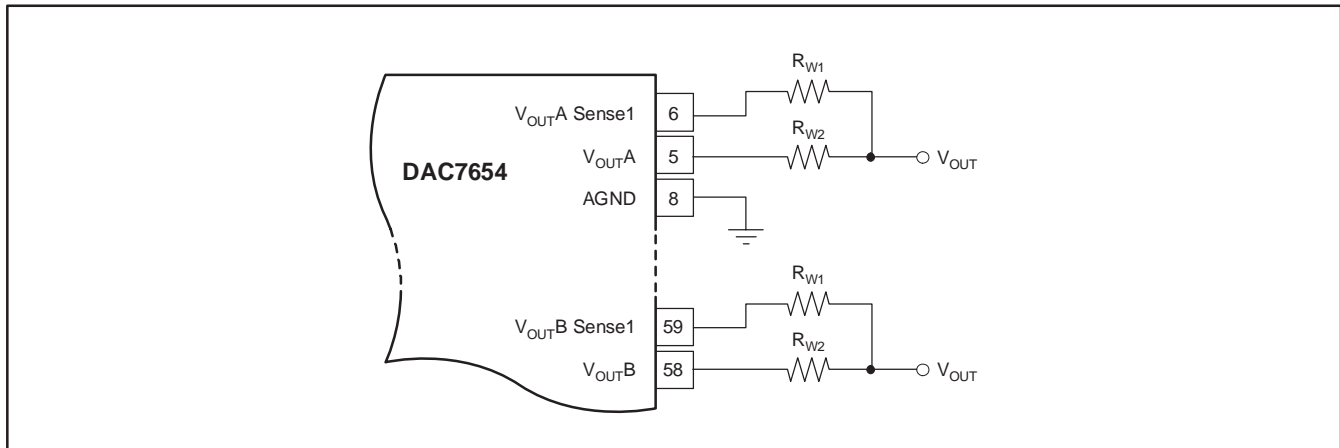


Figure 56. Analog Output Closed-Loop Configuration (1/2 DAC7654).  $R_W$  represents wiring resistances.

Table 1. DAC7654 Logic Truth Table

| A1 | A0 | CS | RST | RSTSEL | LDAC | LOAD | INPUT REGISTER     | DAC REGISTER       | MODE               | DAC |
|----|----|----|-----|--------|------|------|--------------------|--------------------|--------------------|-----|
| L  | L  | L  | H   | X      | X    | L    | Write              | Hold               | Write input        | A   |
| L  | H  | L  | H   | X      | X    | L    | Write              | Hold               | Write input        | B   |
| H  | L  | L  | H   | X      | X    | L    | Write              | Hold               | Write input        | C   |
| H  | H  | L  | H   | X      | X    | L    | Write              | Hold               | Write input        | D   |
| X  | X  | H  | H   | X      | ↑    | H    | Hold               | Write              | Update             | All |
| X  | X  | H  | H   | X      | H    | H    | Hold               | Hold               | Hold               | All |
| X  | X  | X  | ↑   | L      | X    | X    | Reset to zero      | Reset to zero      | Reset to zero      | All |
| X  | X  | X  | ↑   | H      | X    | X    | Reset to mid-scale | Reset to mid-scale | Reset to mid-scale | All |

The DAC code, quick load control, and address are provided via a 24-bit serial interface (see Table 3; also see Figure 58, page 25). The first two bits select the input register that will be updated when  $\overline{\text{LOAD}}$  goes low. The third bit is a Quick Load bit; if high, the code in the shift register is loaded into all of the DAC input registers when the  $\overline{\text{LOAD}}$  signal goes low. If the Quick Load bit is low, the content of shift register is loaded only to the DAC input register that is addressed. The Quick Load bit is followed by five unused bits. The last 16 bits (MSB first) are the DAC code.

The internal DAC register is edge triggered and not level triggered. When the LDAC signal is transitioned from low to high, the digital word currently in the DAC input register is latched. The first set of registers (the DAC input registers) are level triggered via the  $\overline{\text{LOAD}}$  signal. This double-buffered architecture has been designed so that new data can be entered for each DAC without disturbing the analog outputs. When the new data has been entered into the device, all of the DAC outputs can be updated simultaneously by the rising edge of LDAC. Additionally, it allows writing to the DAC input registers at any point, which permits the DAC output voltages to be synchronously changed via a trigger signal (LDAC).

### 3V TO 5V LOGIC INTERFACE

All of the digital input and output pins are compatible with any logic supply voltage between 3V and 5V. Connect the interface logic supply voltage to the IOV<sub>DD</sub> pin. Note that the internal digital logic operates from 5V, so the VDD pin must connect to a 5V supply.

### $\overline{\text{CS}}$ AND CLK INPUTS

Note that  $\overline{\text{CS}}$  and CLK are combined with an OR gate, which controls the serial-to-parallel shift register. These two inputs are completely interchangeable. However, care must be taken with the state of CLK when  $\overline{\text{CS}}$  rises at the end of a serial transfer. If CLK is low when  $\overline{\text{CS}}$  rises, the OR gate will provide a rising edge to the shift register, shifting the internal data by one additional bit. The result will be incorrect data and the possible selection of the wrong input register(s). If both

$\overline{\text{CS}}$  and CLK are used,  $\overline{\text{CS}}$  should rise only when CLK is high. If not, then either  $\overline{\text{CS}}$  or CLK can be used to operate the shift register. Table 2 shows more information.

**Table 2. Serial Shift Register Truth Table**

| CS(1)      | CLK(1)         | $\overline{\text{LOAD}}$ | RST            | SERIAL SHIFT REGISTER |
|------------|----------------|--------------------------|----------------|-----------------------|
| H(2)       | X(2)           | H                        | H              | No change             |
| L(2)       | L              | H                        | H              | No change             |
| L          | $\uparrow$ (2) | H                        | H              | Advanced one bit      |
| $\uparrow$ | L              | H                        | H              | Advanced one bit      |
| H(3)       | X              | L(4)                     | H              | No change             |
| H(3)       | X              | H                        | $\uparrow$ (5) | No change             |

- (1)  $\overline{\text{CS}}$  and CLK are interchangeable.
- (2) H = logic high. X = don't care. L = logic low.  $\uparrow$  = positive logic transition.
- (3) A high value is suggested in order to avoid a false clock from advancing and changing the shift register.
- (4) If data are clocked into the serial register while  $\overline{\text{LOAD}}$  is low, the selected DAC register will change as the shift register bits flow through A1 and A0. This will corrupt the data in each DAC register that has been erroneously selected.
- (5) Rising edge of RST causes no change in the contents of the serial shift register.

### GLITCH SUPPRESSION CIRCUIT

Figure 21, Figure 22, Figure 48, and Figure 49 show the typical DAC output when switching between codes 7FFFh and 8000h. For R-2R ladder DACs, this is potentially the worst-case glitch condition, since every switch in the DAC changes state. To minimize the glitch energy at this and other code pairs with possible high-glitch outputs, an internal track-and-hold circuit is used to maintain the DAC output voltage at a nearly constant level during the internal switching interval. This track-and-hold circuit is activated only when the transition is at, or close to, one of the code pairs with the high-glitch possibility.

It is advisable to avoid digital transitions within 1 $\mu$ s of the rising edge of the LDAC signal. These signals can affect the charge on the track-and-hold capacitor, thus increasing the glitch energy.

**Table 3. 24-Bit Data and Command Word**

| B23 | B22 | B21        | B20 | B19 | B18 | B17 | B16 | B15 | B14 | B13 | B12 | B11 | B10 | B9 | B8 | B7 | B6 | B5 | B4 | B3 | B2 | B1 | B0 |
|-----|-----|------------|-----|-----|-----|-----|-----|-----|-----|-----|-----|-----|-----|----|----|----|----|----|----|----|----|----|----|
| A1  | A0  | Quick Load | X   | X   | X   | X   | X   | D15 | D14 | D13 | D12 | D11 | D10 | D9 | D8 | D7 | D6 | D5 | D4 | D3 | D2 | D1 | D0 |

**SERIAL DATA OUTPUT**

The serial-data output (SDO) is the internal shift register output. For the DAC7654, the SDO is a driven output and does not require an external pull-up. Any number of DAC7654s can be daisy-chained by connecting the SDO pin of one device to the SDI pin of the following device in the chain, as shown in Figure 57.

**DIGITAL TIMING**

Figure 58 and Table 4 provide detailed timing for the digital interface of the DAC7654.

**DIGITAL INPUT CODING**

The DAC7654 input data is in straight binary format. The output voltage for single-supply operation is given by Equation 1:

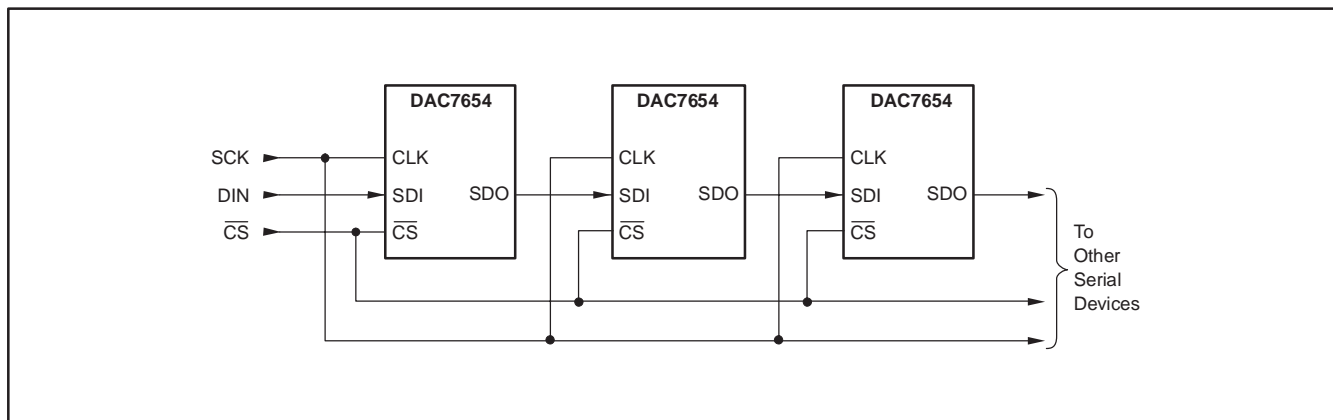
$$V_{OUT} = \frac{2.5 \times N}{65,536} \tag{1}$$

where N is the digital input code.

This equation does not include the effects of offset (zero-scale) or gain (full-scale) errors.

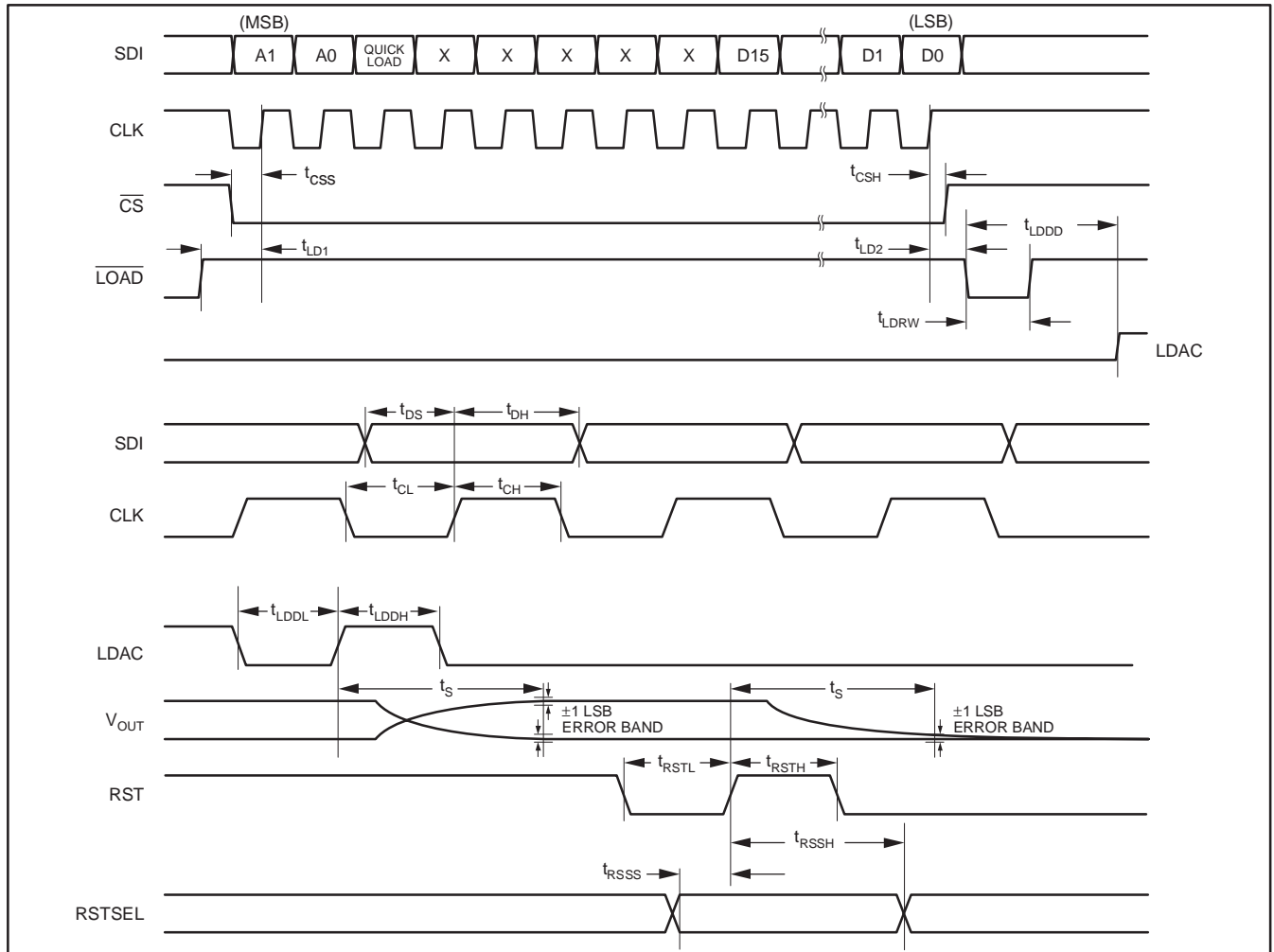
The output for the dual supply operation is given by Equation 2:

$$V_{OUT} = \frac{5 \times N}{65,536} - 2.5 \tag{2}$$



**Figure 57. Daisy-Chaining the DAC7654**





**Figure 58. Digital Input and Output Timing**

**Table 4. Timing Specifications for Figure 58**

| <b>SYMBOL</b>     | <b>DESCRIPTION</b>              | <b>MIN</b> | <b>UNITS</b> |
|-------------------|---------------------------------|------------|--------------|
| t <sub>DS</sub>   | Data valid to CLK rising        | 10         | ns           |
| t <sub>DH</sub>   | Data held valid after CLK rises | 20         | ns           |
| t <sub>CH</sub>   | CLK high                        | 25         | ns           |
| t <sub>CL</sub>   | CLK low                         | 25         | ns           |
| t <sub>CSS</sub>  | CS low to CLK rising            | 15         | ns           |
| t <sub>CSH</sub>  | CLK high to CS rising           | 0          | ns           |
| t <sub>LD1</sub>  | LOAD high to CLK rising         | 10         | ns           |
| t <sub>LD2</sub>  | CLK rising to LOAD low          | 30         | ns           |
| t <sub>LDRW</sub> | LOAD low time                   | 30         | ns           |
| t <sub>LDDL</sub> | LDAC low time                   | 100        | ns           |
| t <sub>LDDH</sub> | LDAC high time                  | 150        | ns           |
| t <sub>LDDD</sub> | LDAC rising from LOAD low       | 40         | ns           |
| t <sub>RSSS</sub> | RSTSEL valid to RST high        | 0          | ns           |
| t <sub>RSSH</sub> | RST high to RSTSEL not valid    | 100        | ns           |
| t <sub>RSTL</sub> | RST low time                    | 10         | ns           |
| t <sub>RSTH</sub> | RST high time                   | 10         | ns           |
| t <sub>S</sub>    | Settling time                   | 10         | μs           |

**PACKAGING INFORMATION**

| Orderable Device | Status <sup>(1)</sup> | Package Type | Package Drawing | Pins | Package Qty | Eco Plan <sup>(2)</sup> | Lead/Ball Finish | MSL Peak Temp <sup>(3)</sup> |
|------------------|-----------------------|--------------|-----------------|------|-------------|-------------------------|------------------|------------------------------|
| DAC7654YBR       | ACTIVE                | LQFP         | PM              | 64   | 1500        | Green (RoHS & no Sb/Br) | CU NIPDAU        | Level-3-260C-168 HR          |
| DAC7654YBRG4     | ACTIVE                | LQFP         | PM              | 64   | 1500        | Green (RoHS & no Sb/Br) | CU NIPDAU        | Level-3-260C-168 HR          |
| DAC7654YBT       | ACTIVE                | LQFP         | PM              | 64   | 250         | Green (RoHS & no Sb/Br) | CU NIPDAU        | Level-3-260C-168 HR          |
| DAC7654YBTG4     | ACTIVE                | LQFP         | PM              | 64   | 250         | Green (RoHS & no Sb/Br) | CU NIPDAU        | Level-3-260C-168 HR          |
| DAC7654YCR       | ACTIVE                | LQFP         | PM              | 64   | 1500        | Green (RoHS & no Sb/Br) | CU NIPDAU        | Level-3-260C-168 HR          |
| DAC7654YCRG4     | ACTIVE                | LQFP         | PM              | 64   | 1500        | Green (RoHS & no Sb/Br) | CU NIPDAU        | Level-3-260C-168 HR          |
| DAC7654YCT       | ACTIVE                | LQFP         | PM              | 64   | 250         | Green (RoHS & no Sb/Br) | CU NIPDAU        | Level-3-260C-168 HR          |
| DAC7654YCTG4     | ACTIVE                | LQFP         | PM              | 64   | 250         | Green (RoHS & no Sb/Br) | CU NIPDAU        | Level-3-260C-168 HR          |
| DAC7654YR        | ACTIVE                | LQFP         | PM              | 64   | 1500        | Green (RoHS & no Sb/Br) | CU NIPDAU        | Level-3-260C-168 HR          |
| DAC7654YRG4      | ACTIVE                | LQFP         | PM              | 64   | 1500        | Green (RoHS & no Sb/Br) | CU NIPDAU        | Level-3-260C-168 HR          |
| DAC7654YT        | ACTIVE                | LQFP         | PM              | 64   | 250         | Green (RoHS & no Sb/Br) | CU NIPDAU        | Level-3-260C-168 HR          |
| DAC7654YTG4      | ACTIVE                | LQFP         | PM              | 64   | 250         | Green (RoHS & no Sb/Br) | CU NIPDAU        | Level-3-260C-168 HR          |

<sup>(1)</sup> The marketing status values are defined as follows:

**ACTIVE:** Product device recommended for new designs.

**LIFEBUY:** TI has announced that the device will be discontinued, and a lifetime-buy period is in effect.

**NRND:** Not recommended for new designs. Device is in production to support existing customers, but TI does not recommend using this part in a new design.

**PREVIEW:** Device has been announced but is not in production. Samples may or may not be available.

**OBSOLETE:** TI has discontinued the production of the device.

<sup>(2)</sup> Eco Plan - The planned eco-friendly classification: Pb-Free (RoHS), Pb-Free (RoHS Exempt), or Green (RoHS & no Sb/Br) - please check <http://www.ti.com/productcontent> for the latest availability information and additional product content details.

**TBD:** The Pb-Free/Green conversion plan has not been defined.

**Pb-Free (RoHS):** TI's terms "Lead-Free" or "Pb-Free" mean semiconductor products that are compatible with the current RoHS requirements for all 6 substances, including the requirement that lead not exceed 0.1% by weight in homogeneous materials. Where designed to be soldered at high temperatures, TI Pb-Free products are suitable for use in specified lead-free processes.

**Pb-Free (RoHS Exempt):** This component has a RoHS exemption for either 1) lead-based flip-chip solder bumps used between the die and package, or 2) lead-based die adhesive used between the die and leadframe. The component is otherwise considered Pb-Free (RoHS compatible) as defined above.

**Green (RoHS & no Sb/Br):** TI defines "Green" to mean Pb-Free (RoHS compatible), and free of Bromine (Br) and Antimony (Sb) based flame retardants (Br or Sb do not exceed 0.1% by weight in homogeneous material)

<sup>(3)</sup> MSL, Peak Temp. -- The Moisture Sensitivity Level rating according to the JEDEC industry standard classifications, and peak solder temperature.

**Important Information and Disclaimer:** The information provided on this page represents TI's knowledge and belief as of the date that it is provided. TI bases its knowledge and belief on information provided by third parties, and makes no representation or warranty as to the accuracy of such information. Efforts are underway to better integrate information from third parties. TI has taken and continues to take reasonable steps to provide representative and accurate information but may not have conducted destructive testing or chemical analysis on incoming materials and chemicals. TI and TI suppliers consider certain information to be proprietary, and thus CAS numbers and other limited information may not be available for release.

In no event shall TI's liability arising out of such information exceed the total purchase price of the TI part(s) at issue in this document sold by TI to Customer on an annual basis.

**TAPE AND REEL INFORMATION**



**QUADRANT ASSIGNMENTS FOR PIN 1 ORIENTATION IN TAPE**



\*All dimensions are nominal

| Device     | Package Type | Package Drawing | Pins | SPQ  | Reel Diameter (mm) | Reel Width W1 (mm) | A0 (mm) | B0 (mm) | K0 (mm) | P1 (mm) | W (mm) | Pin1 Quadrant |
|------------|--------------|-----------------|------|------|--------------------|--------------------|---------|---------|---------|---------|--------|---------------|
| DAC7654YBR | LQFP         | PM              | 64   | 1500 | 330.0              | 24.8               | 12.3    | 12.3    | 2.5     | 16.0    | 24.0   | Q2            |
| DAC7654YBT | LQFP         | PM              | 64   | 250  | 330.0              | 24.8               | 12.3    | 12.3    | 2.5     | 16.0    | 24.0   | Q2            |
| DAC7654YCR | LQFP         | PM              | 64   | 1500 | 330.0              | 24.8               | 12.3    | 12.3    | 2.5     | 16.0    | 24.0   | Q2            |
| DAC7654YCT | LQFP         | PM              | 64   | 250  | 330.0              | 24.8               | 12.3    | 12.3    | 2.5     | 16.0    | 24.0   | Q2            |
| DAC7654YR  | LQFP         | PM              | 64   | 1500 | 330.0              | 24.8               | 12.3    | 12.3    | 2.5     | 16.0    | 24.0   | Q2            |
| DAC7654YT  | LQFP         | PM              | 64   | 250  | 330.0              | 24.8               | 12.3    | 12.3    | 2.5     | 16.0    | 24.0   | Q2            |

**TAPE AND REEL BOX DIMENSIONS**

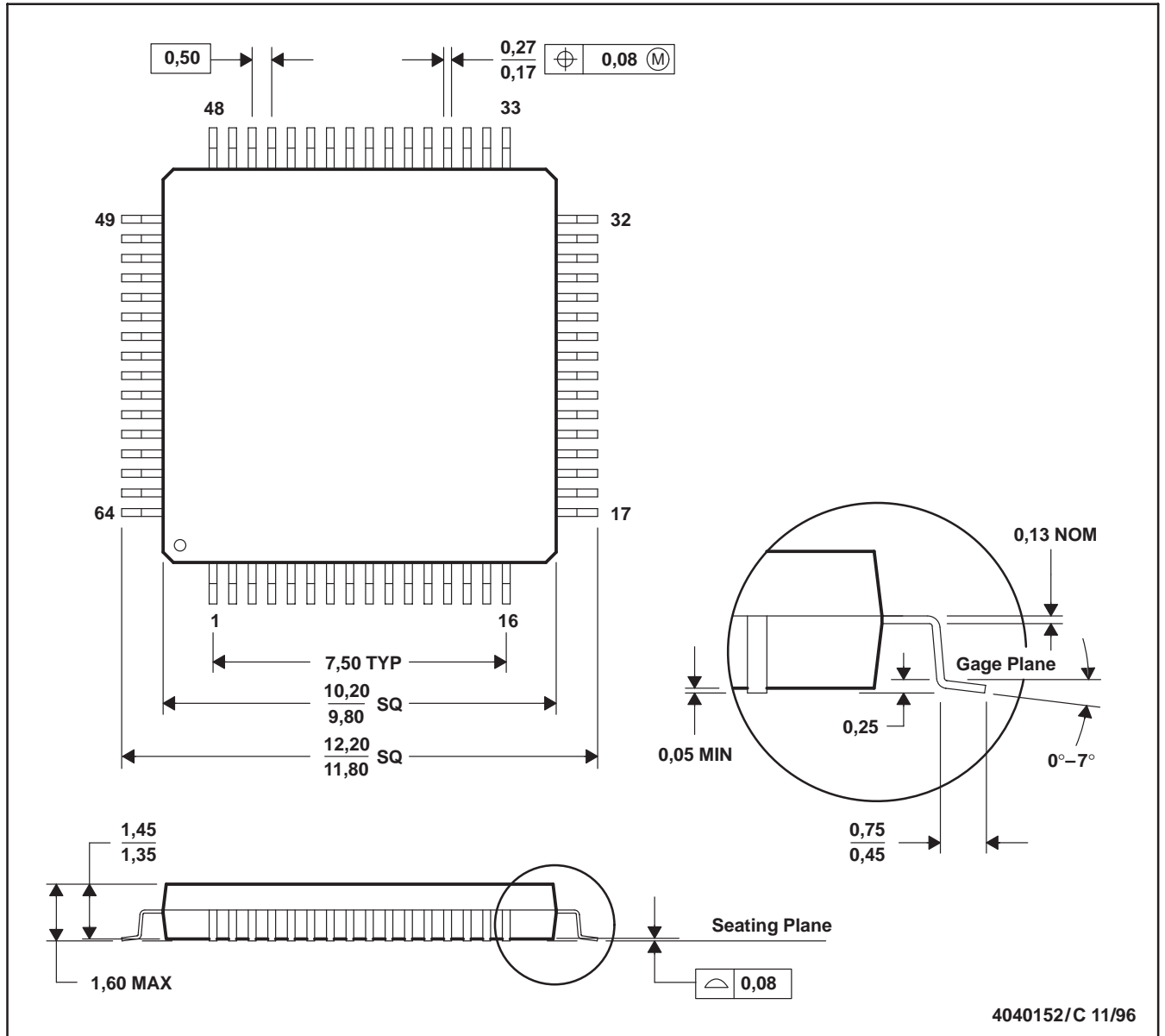


\*All dimensions are nominal

| Device     | Package Type | Package Drawing | Pins | SPQ  | Length (mm) | Width (mm) | Height (mm) |
|------------|--------------|-----------------|------|------|-------------|------------|-------------|
| DAC7654YBR | LQFP         | PM              | 64   | 1500 | 346.0       | 346.0      | 41.0        |
| DAC7654YBT | LQFP         | PM              | 64   | 250  | 346.0       | 346.0      | 41.0        |
| DAC7654YCR | LQFP         | PM              | 64   | 1500 | 346.0       | 346.0      | 41.0        |
| DAC7654YCT | LQFP         | PM              | 64   | 250  | 346.0       | 346.0      | 41.0        |
| DAC7654YR  | LQFP         | PM              | 64   | 1500 | 346.0       | 346.0      | 41.0        |
| DAC7654YT  | LQFP         | PM              | 64   | 250  | 346.0       | 346.0      | 41.0        |

PM (S-PQFP-G64)

PLASTIC QUAD FLATPACK



- NOTES: A. All linear dimensions are in millimeters.  
 B. This drawing is subject to change without notice.  
 C. Falls within JEDEC MS-026  
 D. May also be thermally enhanced plastic with leads connected to the die pads.

## IMPORTANT NOTICE

Texas Instruments Incorporated and its subsidiaries (TI) reserve the right to make corrections, modifications, enhancements, improvements, and other changes to its products and services at any time and to discontinue any product or service without notice. Customers should obtain the latest relevant information before placing orders and should verify that such information is current and complete. All products are sold subject to TI's terms and conditions of sale supplied at the time of order acknowledgment.

TI warrants performance of its hardware products to the specifications applicable at the time of sale in accordance with TI's standard warranty. Testing and other quality control techniques are used to the extent TI deems necessary to support this warranty. Except where mandated by government requirements, testing of all parameters of each product is not necessarily performed.

TI assumes no liability for applications assistance or customer product design. Customers are responsible for their products and applications using TI components. To minimize the risks associated with customer products and applications, customers should provide adequate design and operating safeguards.

TI does not warrant or represent that any license, either express or implied, is granted under any TI patent right, copyright, mask work right, or other TI intellectual property right relating to any combination, machine, or process in which TI products or services are used. Information published by TI regarding third-party products or services does not constitute a license from TI to use such products or services or a warranty or endorsement thereof. Use of such information may require a license from a third party under the patents or other intellectual property of the third party, or a license from TI under the patents or other intellectual property of TI.

Reproduction of TI information in TI data books or data sheets is permissible only if reproduction is without alteration and is accompanied by all associated warranties, conditions, limitations, and notices. Reproduction of this information with alteration is an unfair and deceptive business practice. TI is not responsible or liable for such altered documentation. Information of third parties may be subject to additional restrictions.

Resale of TI products or services with statements different from or beyond the parameters stated by TI for that product or service voids all express and any implied warranties for the associated TI product or service and is an unfair and deceptive business practice. TI is not responsible or liable for any such statements.

TI products are not authorized for use in safety-critical applications (such as life support) where a failure of the TI product would reasonably be expected to cause severe personal injury or death, unless officers of the parties have executed an agreement specifically governing such use. Buyers represent that they have all necessary expertise in the safety and regulatory ramifications of their applications, and acknowledge and agree that they are solely responsible for all legal, regulatory and safety-related requirements concerning their products and any use of TI products in such safety-critical applications, notwithstanding any applications-related information or support that may be provided by TI. Further, Buyers must fully indemnify TI and its representatives against any damages arising out of the use of TI products in such safety-critical applications.

TI products are neither designed nor intended for use in military/aerospace applications or environments unless the TI products are specifically designated by TI as military-grade or "enhanced plastic." Only products designated by TI as military-grade meet military specifications. Buyers acknowledge and agree that any such use of TI products which TI has not designated as military-grade is solely at the Buyer's risk, and that they are solely responsible for compliance with all legal and regulatory requirements in connection with such use.

TI products are neither designed nor intended for use in automotive applications or environments unless the specific TI products are designated by TI as compliant with ISO/TS 16949 requirements. Buyers acknowledge and agree that, if they use any non-designated products in automotive applications, TI will not be responsible for any failure to meet such requirements.

Following are URLs where you can obtain information on other Texas Instruments products and application solutions:

### Products

|                             |  |
|-----------------------------|--|
| Amplifiers                  | <a href="http://amplifier.ti.com">amplifier.ti.com</a>             |
| Data Converters             | <a href="http://dataconverter.ti.com">dataconverter.ti.com</a>     |
| DLP® Products               | <a href="http://www.dlp.com">www.dlp.com</a>                       |
| DSP                         | <a href="http://dsp.ti.com">dsp.ti.com</a>                         |
| Clocks and Timers           | <a href="http://www.ti.com/clocks">www.ti.com/clocks</a>           |
| Interface                   | <a href="http://interface.ti.com">interface.ti.com</a>             |
| Logic                       | <a href="http://logic.ti.com">logic.ti.com</a>                     |
| Power Mgmt                  | <a href="http://power.ti.com">power.ti.com</a>                     |
| Microcontrollers            | <a href="http://microcontroller.ti.com">microcontroller.ti.com</a> |
| RFID                        | <a href="http://www.ti-rfid.com">www.ti-rfid.com</a>               |
| RF/IF and ZigBee® Solutions | <a href="http://www.ti.com/lprf">www.ti.com/lprf</a>               |

### Applications

|                    |  |
|--------------------|--|
| Audio              | <a href="http://www.ti.com/audio">www.ti.com/audio</a>                   |
| Automotive         | <a href="http://www.ti.com/automotive">www.ti.com/automotive</a>         |
| Broadband          | <a href="http://www.ti.com/broadband">www.ti.com/broadband</a>           |
| Digital Control    | <a href="http://www.ti.com/digitalcontrol">www.ti.com/digitalcontrol</a> |
| Medical            | <a href="http://www.ti.com/medical">www.ti.com/medical</a>               |
| Military           | <a href="http://www.ti.com/military">www.ti.com/military</a>             |
| Optical Networking | <a href="http://www.ti.com/opticalnetwork">www.ti.com/opticalnetwork</a> |
| Security           | <a href="http://www.ti.com/security">www.ti.com/security</a>             |
| Telephony          | <a href="http://www.ti.com/telephony">www.ti.com/telephony</a>           |
| Video & Imaging    | <a href="http://www.ti.com/video">www.ti.com/video</a>                   |
| Wireless           | <a href="http://www.ti.com/wireless">www.ti.com/wireless</a>             |

Mailing Address: Texas Instruments, Post Office Box 655303, Dallas, Texas 75265  
Copyright © 2009, Texas Instruments Incorporated