



Dual Digitally Programmable Potentiometer (DPP™) with 64 Taps and I²C Interface



FEATURES

- Two linear-taper digitally programmable potentiometers
- 64 resistor taps per potentiometer
- End to end resistance 2.5 kΩ, 10 kΩ, 50 kΩ or 100 kΩ
- Potentiometer control and memory access via I²C interface
- Low wiper resistance, typically 80 Ω
- Nonvolatile memory storage for up to four wiper settings for each potentiometer
- Automatic recall of saved wiper settings at power up
- 2.5 to 6.0 volt operation
- Standby current less than 1μA
- 1,000,000 nonvolatile WRITE cycles
- 100 year nonvolatile memory data retention
- 20-lead SOIC and TSSOP packages
- Industrial temperature range

DESCRIPTION

The CAT5221 is two Digitally Programmable Potentiometers (DPPs™) integrated with control logic and 16 bytes of NVRAM memory. Each DPP consists of a series of 63 resistive elements connected between two externally accessible end points. The tap points between each resistive element are connected to the wiper outputs with CMOS switches. A separate 6-bit control register (WCR) independently controls the wiper tap switches for each DPP. Associated with each wiper control register are four 6-bit non-volatile memory data registers (DR) used for storing up to four wiper settings. Writing to the wiper control register or any of the non-volatile data registers is via a I²C serial bus. On power-up, the contents of the first data register (DR0) for each of the four potentiometers is automatically loaded into its respective wiper control register (WCR).

The CAT5221 can be used as a potentiometer or as a two terminal, variable resistor. It is intended for circuit level or system level adjustments in a wide variety of applications.

For Ordering Information details, see page 15.

PIN CONFIGURATION

SOIC 20 Lead (W)
TSSOP 20 Lead (Y)

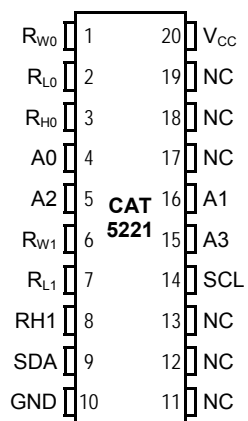

FUNCTIONAL DIAGRAM

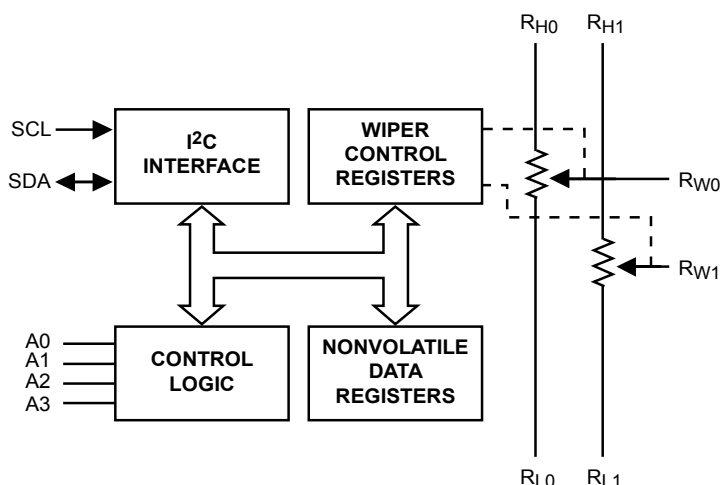

PIN DESCRIPTION

Pin (SOIC)	Name	Function
1	R _{W0}	Wiper Terminal for Potentiometer 0
2	R _{L0}	Low Reference Terminal for Potentiometer 0
3	R _{H0}	High Reference Terminal for Potentiometer 0
4	A0	Device Address, LSB
5	A2	Device Address
6	R _{W1}	Wiper Terminal for Potentiometer 1
7	R _{L1}	Low Reference Terminal for Potentiometer 1
8	R _{H1}	High Reference Terminal for Potentiometer 1
9	SDA	Serial Data Input/Output
10	GND	Ground
11	NC	No Connect
12	NC	No Connect
13	NC	No Connect
14	SCL	Bus Serial Clock
15	A3	Device Address
16	A1	Device Address
17	NC	No Connect
18	NC	No Connect
19	NC	No Connect
20	V _{CC}	Supply Voltage

PIN DESCRIPTION

SCL: Serial Clock

The CAT5221 serial clock input pin is used to clock all data transfers into or out of the device.

SDA: Serial Data

The CAT5221 bidirectional serial data pin is used to transfer data into and out of the device. The SDA pin is an open drain output and can be wire-Or'd with the other open drain or open collector outputs.

A0, A1, A2, A3: Device Address Inputs

These inputs set the device address when addressing multiple devices. A total of sixteen devices can be addressed on a single bus. A match in the slave address must be made with the address input in order to initiate communication with the CAT5221.

R_H, R_L: Resistor End Points

The two sets of R_H and R_L pins are equivalent to the terminal connections on a mechanical potentiometer.

R_W: Wiper

The two R_W pins are equivalent to the wiper terminal of a mechanical potentiometer.

DEVICE OPERATION

The CAT5221 is two resistor arrays integrated with I²C serial interface logic, two 6-bit wiper control registers and eight 6-bit, non-volatile memory data registers. Each resistor array contains 63 separate resistive elements connected in series. The physical ends of each array are equivalent to the fixed terminals of a mechanical potentiometer (R_H and R_L). R_H and R_L are symmetrical and may be interchanged. The tap positions between and at the ends of the series resistors are connected to the output wiper terminals (R_W) by a CMOS transistor switch. Only one tap point for each potentiometer is connected to its wiper terminal at a time and is determined by the value of the wiper control register. Data can be read or written to the wiper control registers or the non-volatile memory data registers via the I²C bus. Additional instructions allow data to be transferred between the wiper control registers and each respective potentiometer's non-volatile data registers. Also, the device can be instructed to operate in an "increment/decrement" mode.

ABSOLUTE MAXIMUM RATINGS⁽¹⁾

Parameter	Ratings	Units
Temperature Under Bias	-55 to +125	°C
Storage Temperature	-65 to +150	°C
Voltage on any Pin with Respect to V_{SS} ⁽²⁾	-2.0 to $+V_{CC} + 2.0$	V
V_{CC} with Respect to Ground	-2.0 to +7.0	V
Package Power Dissipation Capability ($T_A = 25^\circ\text{C}$)	1.0	W
Lead Soldering Temperature (10s)	300	°C
Wiper Current	± 12	mA

RECOMMENDED OPERATING CONDITIONS

$V_{CC} = +2.5 \text{ V to } +6 \text{ V}$

Parameter	Ratings	Units
Operating Ambient Temperature (Industrial)	-40 to +85	°C

POTENTIOMETER CHARACTERISTICS

Over recommended operating conditions unless otherwise stated.

Symbol	Parameter	Test Conditions	Min	Typ	Max	Units
R_{POT}	Potentiometer Resistance (-00)			100		k Ω
R_{POT}	Potentiometer Resistance (-50)			50		k Ω
R_{POT}	Potentiometer Resistance (-10)			10		k Ω
R_{POT}	Potentiometer Resistance (-2.5)			2.5		k Ω
	Potentiometer Resistance Tolerance				± 20	%
	R_{POT} Matching				1	%
	Power Rating	25°C, each pot			50	mW
I_W	Wiper Current				± 6	mA
R_W	Wiper Resistance	$I_W = +3 \text{ mA @ } V_{CC} = 3 \text{ V}$			300	Ω
R_W	Wiper Resistance	$I_W = +3 \text{ mA @ } V_{CC} = 5 \text{ V}$		80	150	Ω
V_{TERM}	Voltage on any R_H or R_L Pin	$V_{SS} = 0 \text{ V}$	GND		V_{CC}	
V_N	Noise	(4)		TBD		nV/ $\sqrt{\text{Hz}}$
	Resolution			1.6		%
	Absolute Linearity ⁽⁵⁾	$R_{W(n)(\text{actual})} - R_{(n)(\text{expected})}$ ⁽⁸⁾			± 1	LSB ⁽⁷⁾
	Relative Linearity ⁽⁶⁾	$R_{W(n+1)} - [R_{W(n)+LSB}]$ ⁽⁸⁾			± 0.2	LSB ⁽⁷⁾
TC_{RPOT}	Temperature Coefficient of R_{POT}	(4)		± 300		ppm/°C
TC_{RATIO}	Ratiometric Temp. Coefficient	(4)			20	ppm/°C
$C_H/C_L/C_W$	Potentiometer Capacitances	(4)		10/10/25		pF
fc	Frequency Response	$R_{POT} = 50 \text{ k}\Omega$		0.4		MHz

Notes:

- (1) Stresses above those listed under "Absolute Maximum Ratings" may cause permanent damage to the device. These are stress ratings only, and functional operation of the device at these or any other conditions outside of those listed in the operational sections of this specification is not implied. Exposure to any absolute maximum rating for extended periods may affect device performance and reliability.
- (2) The minimum DC input voltage is -0.5 V . During transitions, inputs may undershoot to -2.0 V for periods of less than 20 ns. Maximum DC voltage on output pins is $V_{CC} + 0.5 \text{ V}$, which may overshoot to $V_{CC} + 2.0 \text{ V}$ for periods of less than 20 ns.
- (3) Latch-up protection is provided for stresses up to 100 mA on address and data pins from -1 V to $V_{CC} + 1 \text{ V}$.
- (4) This parameter is tested initially and after a design or process change that affects the parameter.
- (5) Absolute linearity is utilized to determine actual wiper voltage versus expected voltage as determined by wiper position when used as a potentiometer.
- (6) Relative linearity is utilized to determine the actual change in voltage between two successive tap positions when used as a potentiometer. It is a measure of the error in step size.
- (7) $LSB = R_{TOT} / 63$ or $(R_H - R_L) / 63$, single pot
- (8) $n = 0, 1, 2, \dots, 63$

D.C. OPERATING CHARACTERISTICS

Over recommended operating conditions unless otherwise stated.

Symbol	Parameter	Test Conditions	Min	Typ	Max	Units
I _{CC}	Power Supply Current	f _{SCL} = 400 kHz			1	mA
I _{SB}	Standby Current (V _{CC} = 5.0 V)	V _{IN} = GND or V _{CC} ; SDA Open			1	μA
I _{LI}	Input Leakage Current	V _{IN} = GND to V _{CC}			10	μA
I _{LO}	Output Leakage Current	V _{OUT} = GND to V _{CC}			10	μA
V _{IL}	Input Low Voltage		-1		V _{CC} x 0.3	V
V _{IH}	Input High Voltage		V _{CC} x 0.7		V _{CC} + 1.0	V
V _{OL1}	Output Low Voltage (V _{CC} = 3.0 V)	I _{OL} = 3 mA			0.4	V

CAPACITANCE

T_A = 25°C, f = 1.0 MHz, V_{CC} = 5 V

Symbol	Parameter	Test Conditions	Min	Typ	Max	Units
C _{I/O} ⁽¹⁾	Input/Output Capacitance (SDA)	V _{I/O} = 0 V			8	pF
C _{IN} ⁽¹⁾	Input Capacitance (A0, A1, A2, A3, SCL)	V _{IN} = 0 V			6	pF

A.C. CHARACTERISTICS

Over recommended operating conditions unless otherwise stated.

Symbol	Parameter	Min	Typ	Max	Units
f _{SCL}	Clock Frequency			400	kHz
T _I ⁽¹⁾	Noise Suppression Time Constant at SCL, SDA Inputs			50	ns
t _{AA}	SLC Low to SDA Data Out and ACK Out			0.9	μs
t _{BUF} ⁽¹⁾	Time the Bus Must Be Free Before a New Transmission Can Start	1.2			μs
t _{HD:STA}	Start Condition Hold Time	0.6			μs
t _{LOW}	Clock Low Period	1.2			μs
t _{HIGH}	Clock High Period	0.6			μs
t _{SU:STA}	Start Condition Setup Time (For a Repeated Start Condition)	0.6			μs
t _{HD:DAT}	Data in Hold Time	0			ns
t _{SU:DAT}	Data in Setup Time	100			ns
t _R ⁽¹⁾	SDA and SCL Rise Time			0.3	μs
t _F ⁽¹⁾	SDA and SCL Fall Time			300	ns
t _{SU:STO}	Stop Condition Setup Time	0.6			μs
t _{DH}	Data Out Hold Time	50			ns

POWER UP TIMING ⁽¹⁾

Over recommended operating conditions unless otherwise stated.

Symbol	Parameter	Min	Typ	Max	Units
t _{PUR}	Power-up to Read Operation			1	ms
t _{PUW}	Power-up to Write Operation			1	ms

Note:

(1) This parameter is tested initially and after a design or process change that affects the parameter.

WRITE CYCLE LIMITS

Over recommended operating conditions unless otherwise stated.

Symbol	Parameter	Min	Typ	Max	Units
t_{WR}	Write Cycle Time			5	ms

The write cycle is the time from a valid stop condition of a write sequence to the end of the internal program/erase cycle. During the write cycle, the bus interface circuits are disabled, SDA is allowed to remain high, and the device does not respond to its slave address.

RELIABILITY CHARACTERISTICS

Over recommended operating conditions unless otherwise stated.

Symbol	Parameter	Reference Test Method	Min	Typ	Max	Units
NEND ⁽¹⁾	Endurance	MIL-STD-883, Test Method 1033	1,000,000			Cycles/Byte
TDR ⁽¹⁾	Data Retention	MIL-STD-883, Test Method 1008	100			Years
VZAP ⁽¹⁾	ESD Susceptibility	MIL-STD-883, Test Method 3015	2000			Volts
ILTH ⁽¹⁾⁽²⁾	Latch-Up	JEDEC Standard 17	100			mA

Note:

- (1) This parameter is tested initially and after a design or process change that affects the parameter.
- (2) t_{PUR} and t_{PUW} are the delays required from the time V_{CC} is stable until the specified operation can be initiated.

Figure 1. Bus Timing

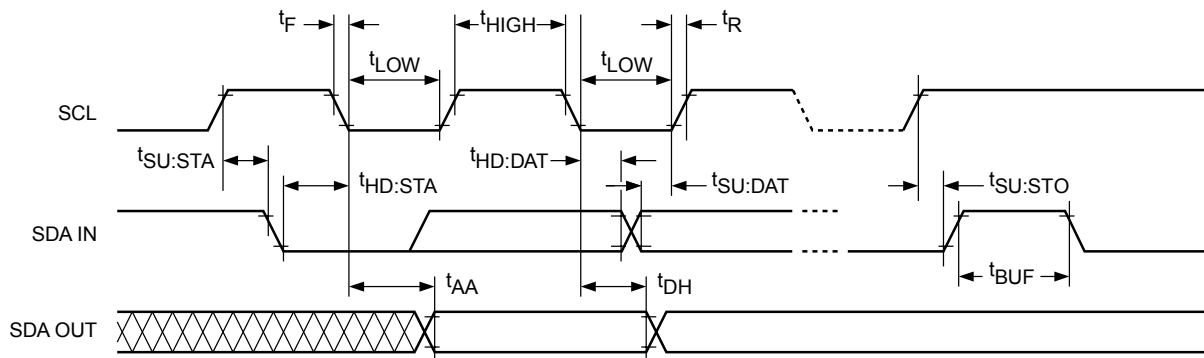

Figure 2. Write Cycle Timing

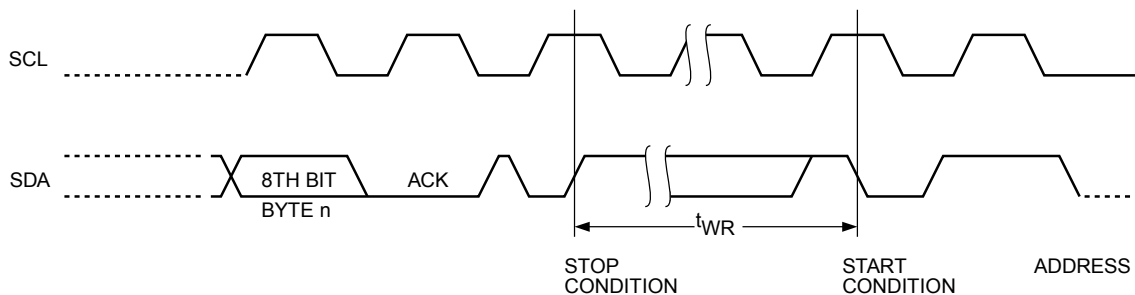
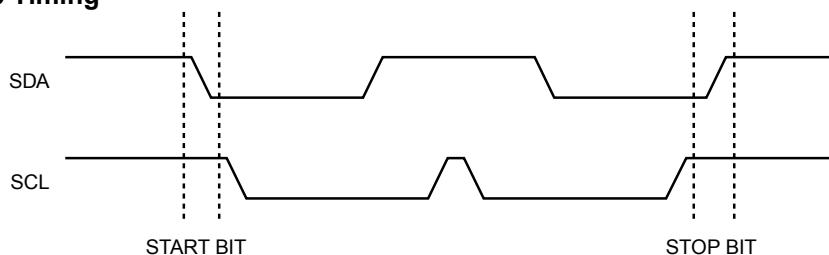

Figure 3. Start/Stop Timing



SERIAL BUS PROTOCOL

The following defines the features of the I²C bus protocol:

- (1) Data transfer may be initiated only when the bus is not busy.
- (2) During a data transfer, the data line must remain stable whenever the clock line is high. Any changes in the data line while the clock is high will be interpreted as a START or STOP condition.

The device controlling the transfer is a master, typically a processor or controller, and the device being controlled is the slave. The master will always initiate data transfers and provide the clock for both transmit and receive operations. Therefore, the CAT5221 will be considered a slave device in all applications.

START Condition

The START Condition precedes all commands to the device, and is defined as a HIGH to LOW transition of SDA when SCL is HIGH. The CAT5221 monitors the SDA and SCL lines and will not respond until this condition is met.

STOP Condition

A LOW to HIGH transition of SDA when SCL is HIGH determines the STOP condition. All operations must end with a STOP condition.

DEVICE ADDRESSING

The bus Master begins a transmission by sending a START condition. The Master then sends the address

of the particular slave device it is requesting. The four most significant bits of the 8-bit slave address are fixed as 0101 for the CAT5221 (see Figure 5). The next four significant bits (A3, A2, A1, A0) are the device address bits and define which device the Master is accessing. Up to sixteen devices may be individually addressed by the system. Typically, +5V and ground are hard-wired to these pins to establish the device's address.

After the Master sends a START condition and the slave address byte, the CAT5221 monitors the bus and responds with an acknowledge (on the SDA line) when its address matches the transmitted slave address.

Acknowledge

After a successful data transfer, each receiving device is required to generate an acknowledge. The Acknowledging device pulls down the SDA line during the ninth clock cycle, signaling that it received the 8 bits of data.

The CAT5221 responds with an acknowledge after receiving a START condition and its slave address. If the device has been selected along with a write operation, it responds with an acknowledge after receiving each 8-bit byte.

When the CAT5221 is in a READ mode it transmits 8 bits of data, releases the SDA line, and monitors the line for an acknowledge. Once it receives this acknowledge, the CAT5221 will continue to transmit data. If no acknowledge is sent by the Master, the device terminates data transmission and waits for a STOP condition.

Figure 4. Acknowledge Timing

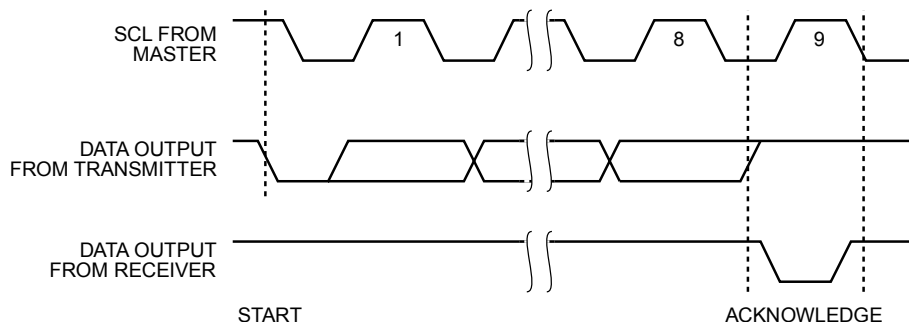

WRITE OPERATION

In the Write mode, the Master device sends the START condition and the slave address information to the Slave device. After the Slave generates an acknowledge, the Master sends the instruction byte that defines the requested operation of CAT5221. The instruction byte consist of a four-bit opcode followed by two register selection bits and two pot selection bits. After receiving another acknowledge from the Slave, the Master device transmits the data to be written into the selected register. The CAT5221 acknowledges once more and the Master generates the STOP condition, at which time if a nonvolatile data register is being selected, the device begins an internal programming cycle to non-volatile memory. While this internal cycle is in progress, the device will not respond to any request from the Master device.

Acknowledge Polling

The disabling of the inputs can be used to take advantage of the typical write cycle time. Once the stop condition is issued to indicate the end of the host's write operation, the CAT5221 initiates the internal write cycle. ACK polling can be initiated immediately. This involves issuing the start condition followed by the slave address. If the CAT5221 is still busy with the write operation, no ACK will be returned. If the CAT5221 has completed the write operation, an ACK will be returned and the host can then proceed with the next instruction operation.

Figure 5. Slave Address Bits

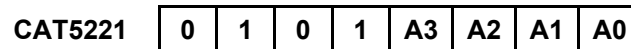

* A0, A1, A2 and A3 correspond to pin A0, A1, A2 and A3 of the device.

** A0, A1, A2 and A3 must compare to its corresponding hard wired input pins.

Figure 6. Write Timing

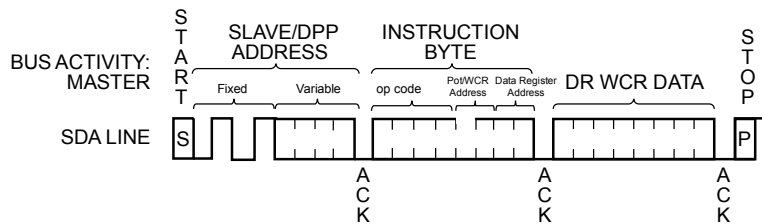

INSTRUCTIONS AND REGISTER DESCRIPTION

INSTRUCTIONS

SLAVE ADDRESS BYTE

The first byte sent to the CAT5221 from the master/processor is called the Slave/DPP Address Byte. The most significant four bits of the slave address are a device type identifier. These bits for the CAT5221 are fixed at 0101[B] (refer to Table 1).

The next four bits, A3 - A0, are the internal slave address and must match the physical device address which is defined by the state of the A3 - A0 input pins for the CAT5221 to successfully continue the command sequence. Only the device which slave address matches the incoming device address sent by the master executes the instruction. The A3 - A0 inputs can be actively driven by CMOS input signals or tied to V_{CC} or V_{SS}.

INSTRUCTION BYTE

The next byte sent to the CAT5221 contains the instruction and register pointer information. The four most significant bits used provide the instruction opcode I [3:0]. The P0 bit points to one of the Wiper Control Registers. The least two significant bits, R1 and R0, point to one of the four data registers of each associated potentiometer. The format is shown in Table 2.

Data Register Selection

Data Register Selected	R1	R0
DR0	0	0
DR1	0	1
DR2	1	0
DR3	1	1

Table 1. Identification Byte Format

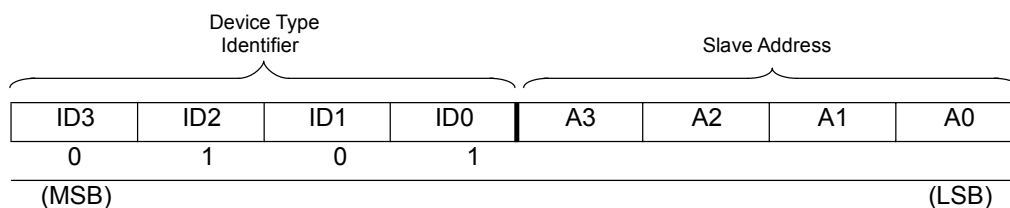
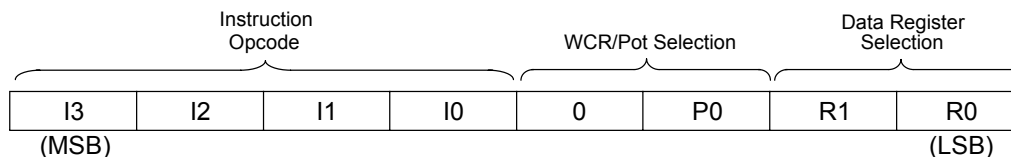

Table 2. Instruction Byte Format



WIPER CONTROL AND DATA REGISTERS

Wiper Control Register (WCR)

The CAT5221 contains two 6-bit Wiper Control Registers, one for each potentiometer. The Wiper Control Register output is decoded to select one of 64 switches along its resistor array. The contents of the WCR can be altered in four ways: it may be written by the host via Write Wiper Control Register instruction; it may be written by transferring the contents of one of four associated Data Registers via the XFR Data Register instruction, it can be modified one step at a time by the Increment/decrement instruction (see Instruction section for more details). Finally, it is loaded with the content of its data register zero (DR0) upon power-up.

The Wiper Control Register is a volatile register that loses its contents when the CAT5221 is powered-down. Although the register is automatically loaded with the value in DR0 upon power-up, this may be different from the value present at power-down.

Data Registers (DR)

Each potentiometer has four 6-bit non-volatile Data Registers. These can be read or written directly by the host. Data can also be transferred between any of the

four Data Registers and the associated Wiper Control Register. Any data changes in one of the Data Registers is a non-volatile operation and will take a maximum of 5ms.

If the application does not require storage of multiple settings for the potentiometer, the Data Registers can be used as standard memory locations for system parameters or user preference data.

Instructions

Four of the nine instructions are three bytes in length. These instructions are:

- **Read Wiper Control Register** – read the current wiper position of the selected potentiometer in the WCR
- **Write Wiper Control Register** – change current wiper position in the WCR of the selected potentiometer
- **Read Data Register** – read the contents of the selected Data Register
- **Write Data Register** – write a new value to the selected Data Register

The basic sequence of the three byte instructions is illustrated in Figure 8. These three-byte instructions

Table 3. Instruction Set

Instruction	Instruction Set								Operation
	I3	I2	I1	I0	0	WCR0/ P0	R1	R0	
Read Wiper Control Register	1	0	0	1	0	1/0	0	0	Read the contents of the Wiper Control Register pointed to by P0
Write Wiper Control Register	1	0	1	0	0	1/0	0	0	Write new value to the Wiper Control Register pointed to by P0
Read Data Register	1	0	1	1	0	1/0	1/0	1/0	Read the contents of the Data Register pointed to by P0 and R1-R0
Write Data Register	1	1	0	0	0	1/0	1/0	1/0	Write new value to the Data Register pointed to by P0 and R1-R0
XFR Data Register to Wiper Control Register	1	1	0	1	0	1/0	1/0	1/0	Transfer the contents of the Data Register pointed to by P0 and R1-R0 to its associated Wiper Control Register
XFR Wiper Control Register to Data Register	1	1	1	0	0	1/0	1/0	1/0	Transfer the contents of the Wiper Control Register pointed to by P0 to the Data Register pointed to by R1-R0
Global XFR Data Registers to Wiper Control Registers	0	0	0	1	0	0	1/0	1/0	Transfer the contents of the Data Registers pointed to by R1-R0 of all four pots to their respective Wiper Control Registers
Global XFR Wiper Control Registers to Data Register	1	0	0	0	0	0	1/0	1/0	Transfer the contents of both Wiper Control Registers to their respective data Registers pointed to by R1-R0 of all four pots
Increment/Decrement Wiper Control Register	0	0	1	0	0	1/0	0	0	Enable Increment/decrement of the Control Latch pointed to by P0

Note: 1/0 = data is one or zero

exchange data between the WCR and one of the Data Registers. The WCR controls the position of the wiper. The response of the wiper to this action will be delayed by t_{WRL} . A transfer from the WCR (current wiper position), to a Data Register is a write to non-volatile memory and takes a maximum of t_{WR} to complete. The transfer can occur between one of the four potentiometers and one of its associated registers; or the transfer can occur between all potentiometers and one associated register.

Four instructions require a two-byte sequence to complete, as illustrated in Figure 7. These instructions transfer data between the host/processor and the CAT5221; either between the host and one of the data registers or directly between the host and the Wiper Control Register. These instructions are:

- **XFR Data Register to Wiper Control Register**
This transfers the contents of one specified Data Register to the associated Wiper Control Register.
- **XFR Wiper Control Register to Data Register**
This transfers the contents of the specified Wiper Control Register to the specified associated Data Register.

— **Global XFR Data Register to Wiper Control Register**

This transfers the contents of all specified Data Registers to the associated Wiper Control Registers.

— **Global XFR Wiper Counter Register to Data Register**

This transfers the contents of all Wiper Control Registers to the specified associated Data Registers.

INCREMENT/DECREMENT COMMAND

The final command is Increment/Decrement (Figure 5 and 9). The Increment/Decrement command is different from the other commands. Once the command is issued and the CAT5221 has responded with an acknowledge, the master can clock the selected wiper up and/or down in one segment steps; thereby providing a fine tuning capability to the host. For each SCL clock pulse (t_{HIGH}) while SDA is HIGH, the selected wiper will move one resistor segment towards the R_H terminal. Similarly, for each SCL clock pulse while SDA is LOW, the selected wiper will move one resistor segment towards the R_L terminal.

See Instructions format for more detail.

Figure 7. Two-Byte Instruction Sequence

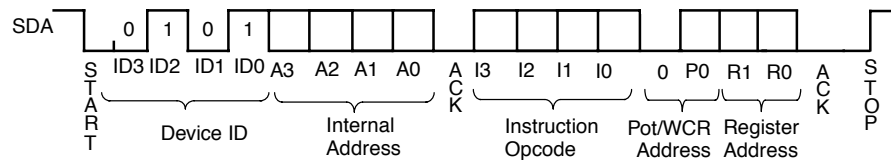

Figure 8. Three-Byte Instruction Sequence

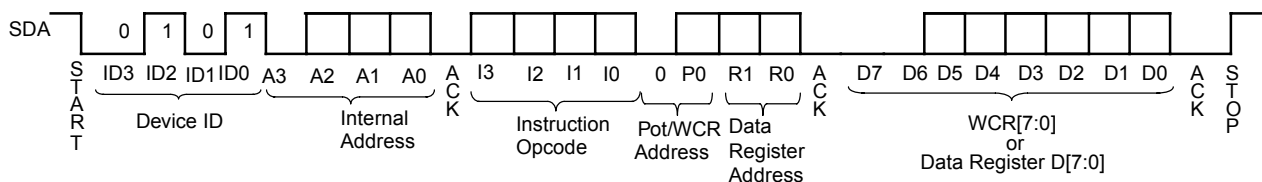

Figure 9. Increment/Decrement Instruction Sequence

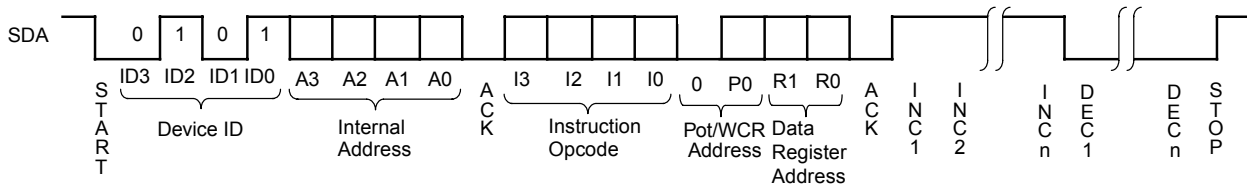
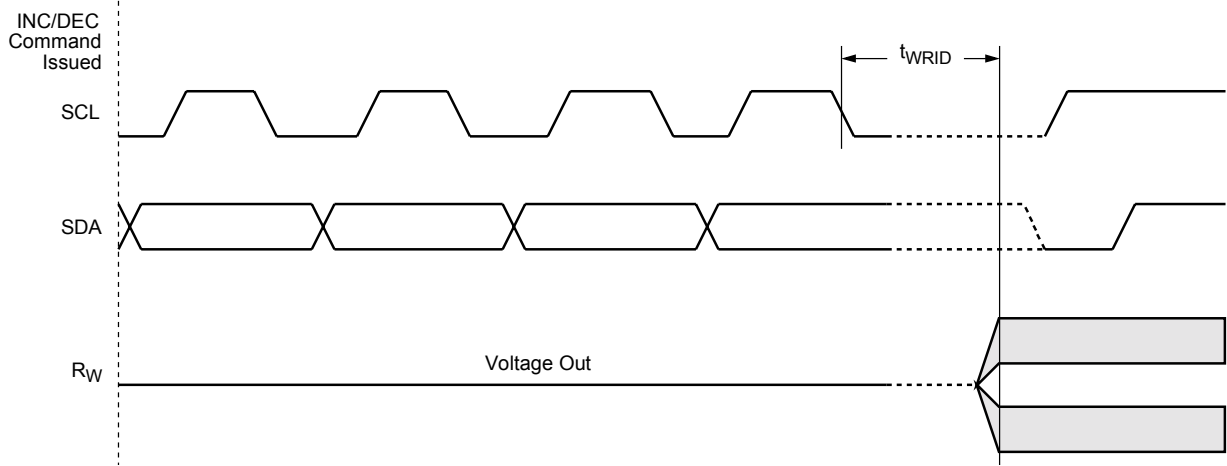

Figure 10. Increment/Decrement Timing Limits



INSTRUCTION FORMAT

Read Wiper Control Register (WCR)

S T A R T	DEVICE ADDRESSES							A C K	INSTRUCTION							A C K	DATA							A C K	S T O P
	0	1	0	1	A3	A2	A1		A0	1	0	0	1	0	P0		0	0	7	6	5	4	3		

Write Wiper Control Register (WCR)

S T A R T	DEVICE ADDRESSES							A C K	INSTRUCTION							A C K	DATA							A C K	S T O P
	0	1	0	1	A3	A2	A1		A0	1	0	1	0	0	P0		0	0	7	6	5	4	3		

Read Data Register (DR)

S T A R T	DEVICE ADDRESSES							A C K	INSTRUCTION							A C K	DATA							A C K	S T O P
	0	1	0	1	A3	A2	A1		A0	1	0	1	1	0	P0		R1	R0	7	6	5	4	3		

Write Data Register (DR)

S T A R T	DEVICE ADDRESSES							A C K	INSTRUCTION							A C K	DATA							A C K	S T O P
	0	1	0	1	A3	A2	A1		A0	1	1	0	0	0	P0		R1	R0	7	6	5	4	3		

Global Transfer Data Register (DR) to Wiper Control Register (WCR)

S T A R T	DEVICE ADDRESSES							A C K	INSTRUCTION						A C K	S T O P
	0	1	0	1	A3	A2	A1		A0	0	0	0	1	0		

Global Transfer Wiper Control Register (WCR) to Data Register (DR)

S T A R T	DEVICE ADDRESSES							A C K	INSTRUCTION						A C K	S T O P
	0	1	0	1	A3	A2	A1		A0	1	0	0	0	0		

Transfer Wiper Control Register (WCR) to Data Register (DR)

S T A R T	DEVICE ADDRESSES							A C K	INSTRUCTION						A C K	S T O P
	0	1	0	1	A3	A2	A1		A0	1	1	1	0	0		

Transfer Data Register (DR) to Wiper Control Register (WCR)

S T A R T	DEVICE ADDRESSES							A C K	INSTRUCTION						A C K	S T O P
	0	1	0	1	A3	A2	A1		A0	1	1	0	1	0		

Increment (I)/Decrement (D) Wiper Control Register (WCR)

S T A R T	DEVICE ADDRESSES							A C K	INSTRUCTION						DATA				S T O P	
	0	1	0	1	A3	A2	A1		A0	0	0	1	0	0	P0	0	0	I/D		I/D

Notes:

(1) Any write or transfer to the Non-volatile Data Registers is followed by a high voltage cycle after a STOP has been issued.

PACKAGING OUTLINE DRAWINGS

SOIC 20-Lead 300 mil Wide (W)⁽¹⁾⁽²⁾

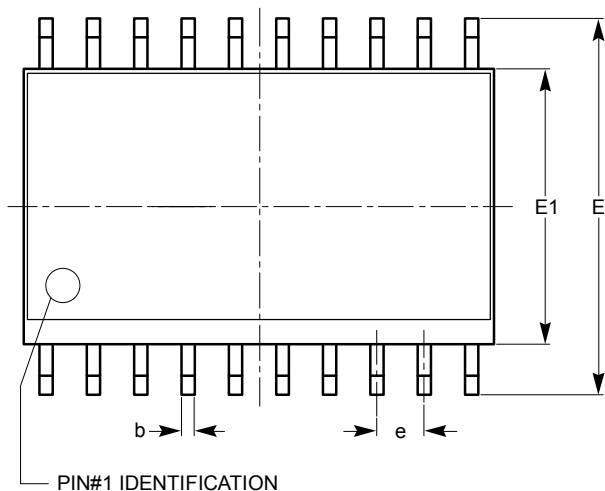

TOP VIEW

SYMBOL	MIN	NOM	MAX
A	2.36	2.49	2.64
A1	0.10		0.30
A2	2.05		2.55
b	0.31	0.41	0.51
c	0.20	0.27	0.33
D	12.60	12.80	13.00
E	10.01	10.30	10.64
E1	7.40	7.50	7.60
e	1.27 BSC		
h	0.25		0.75
L	0.40	0.81	1.27
θ	0°		8°
$\theta 1$	5°		15°

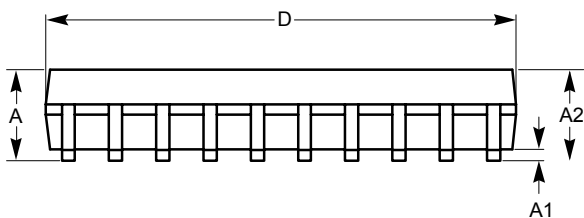

SIDE VIEW

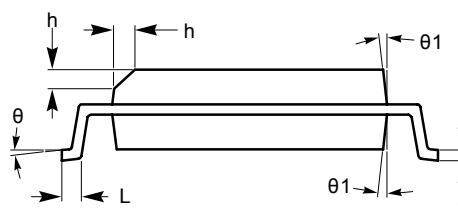

END VIEW

For current Tape and Reel information, download the PDF file from:
<http://www.catsemi.com/documents/tapeandreel.pdf>.

Notes:

- (1) All dimensions are in millimeters.
- (2) Complies with JEDEC specification MS-013.

TSSOP 20-Lead (Y)⁽¹⁾⁽²⁾

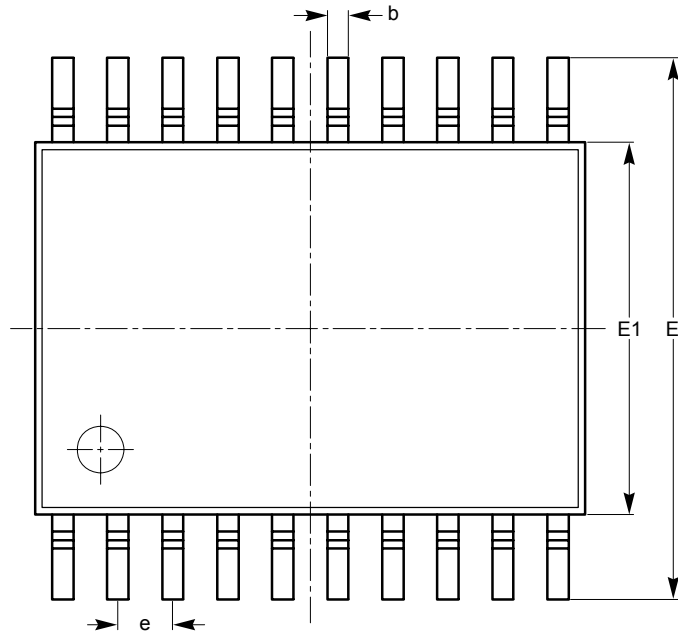

TOP VIEW

SYMBOL	MIN	NOM	MAX
A			1.20
A1	0.05		0.15
A2	0.80		1.05
b	0.19		0.30
c	0.09		0.20
D	6.40	6.50	6.60
E	6.30	6.40	6.50
E1	4.30	4.40	4.50
e	0.65 BSC		
L	0.45	0.60	0.75
L1	1.00 REF		
$\theta 1$	0°		8°

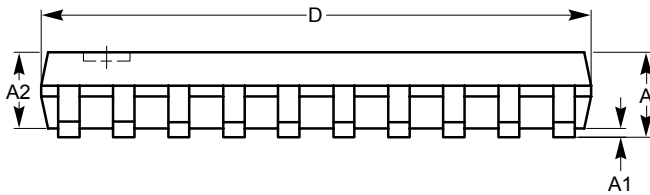

SIDE VIEW

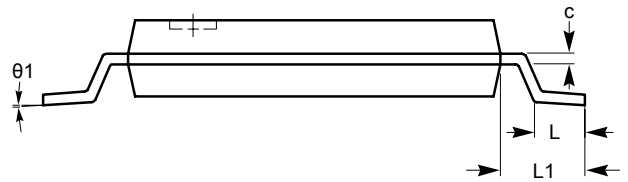

END VIEW

For current Tape and Reel information, download the PDF file from:
<http://www.catsemi.com/documents/tapeand reel.pdf>.

Notes:

- (1) All dimensions are in millimeters. Angles in degree.
- (2) Complies with JEDEC specification MO-153.

EXAMPLE OF ORDERING INFORMATION

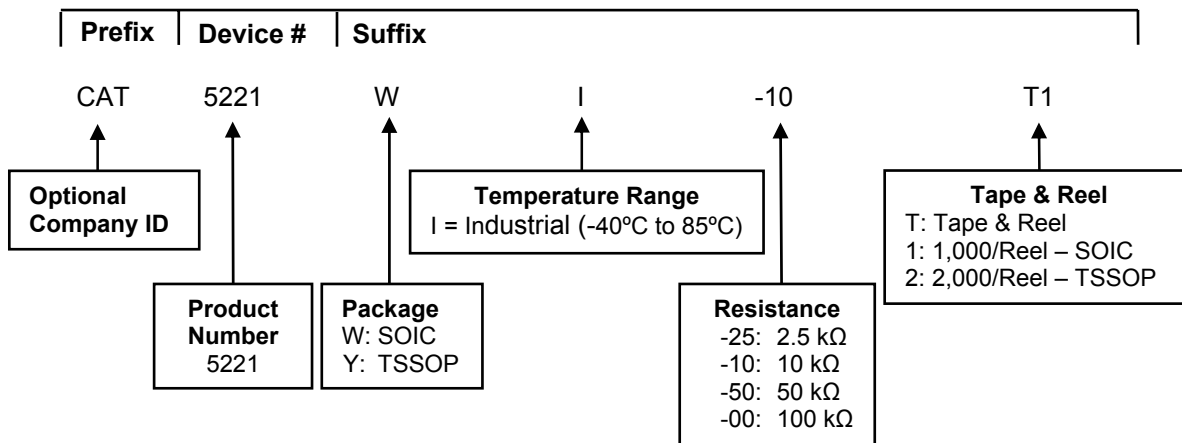

ORDERING INFORMATION

Orderable Part Number	Resistance (kΩ)	Package	Lead Finish
CAT5221WI-25-T1	2.5	SOIC	Matte-Tin
CAT5221WI-10-T1	10		
CAT5221WI-50-T1	50		
CAT5221WI-00-T1	100		
CAT5221YI-25-T2	2.5	TSSOP	
CAT5221YI-10-T2	10		
CAT5221YI-50-T2	50		
CAT5221YI-00-T2	100		
CAT5221WI25	2.5	SOIC	
CAT5221WI10	10		
CAT5221WI50	50		
CAT5221WI00	100		
CAT5221YI25	2.5	TSSOP	
CAT5221YI10	10		
CAT5221YI50	50		
CAT5221YI00	100		

Notes:

- (1) All packages are RoHS-compliant (Lead-free, Halogen-free).
- (2) The standard lead finish is Matte-Tin.
- (3) This device used in the above example is a CAT5221WI-10-T1 (SOIC, Industrial Temperature, 10 kΩ, Tape & Reel, 1,000/Reel)

REVISION HISTORY

Date	Rev.	Reason
30-Sep-03	E	Deleted WP from Functional Diagram, pg. 1
01-Oct-03	F	Changed designation to Advance
10-Mar-04	G	Added TSSOP package in all areas
25-Mar-04	H	Updated TSSOP package drawing
08-Apr-04	I	Eliminated data sheet designation Eliminated Commercial temperature range in all areas Updated Potentiometer Characteristics
23-May-07	J	Updated Example of Ordering Information Added MD- in front of Document No.
12-Mar-08	K	Updated Package Outline Drawing
01-Dec-08	L	Change logo and fine print to ON Semiconductor
28-Jul-09	M	Update Ordering Information table

ON Semiconductor and  are registered trademarks of Semiconductor Components Industries, LLC (SCILLC). SCILLC reserves the right to make changes without further notice to any products herein. SCILLC makes no warranty, representation or guarantee regarding the suitability of its products for any particular purpose, nor does SCILLC assume any liability arising out of the application or use of any product or circuit, and specifically disclaims any and all liability, including without limitation special, consequential or incidental damages. "Typical" parameters which may be provided in SCILLC data sheets and/or specifications can and do vary in different applications and actual performance may vary over time. All operating parameters, including "Typicals" must be validated for each customer application by customer's technical experts. SCILLC does not convey any license under its patent rights nor the rights of others. SCILLC products are not designed, intended, or authorized for use as components in systems intended for surgical implant into the body, or other applications intended to support or sustain life, or for any other application in which the failure of the SCILLC product could create a situation where personal injury or death may occur. Should Buyer purchase or use SCILLC products for any such unintended or unauthorized application, Buyer shall indemnify and hold SCILLC and its officers, employees, subsidiaries, affiliates, and distributors harmless against all claims, costs, damages, and expenses, and reasonable attorney fees arising out of, directly or indirectly, any claim of personal injury or death associated with such unintended or unauthorized use, even if such claim alleges that SCILLC was negligent regarding the design or manufacture of the part. SCILLC is an Equal Opportunity/Affirmative Action Employer. This literature is subject to all applicable copyright laws and is not for resale in any manner.

PUBLICATION ORDERING INFORMATION

LITERATURE FULFILLMENT:

Literature Distribution Center for ON Semiconductor
P.O. Box 5163, Denver, Colorado 80217 USA
Phone: 303-675-2175 or 800-344-3860 Toll Free USA/Canada
Fax: 303-675-2176 or 800-344-3867 Toll Free USA/Canada
Email: orderlit@onsemi.com

N. American Technical Support: 800-282-9855 Toll Free
USA/Canada
Europe, Middle East and Africa Technical Support:
Phone: 421 33 790 2910
Japan Customer Focus Center:
Phone: 81-3-5773-3850

ON Semiconductor Website: www.onsemi.com

Order Literature: <http://www.onsemi.com/orderlit>

For additional information, please contact your local Sales Representative