

Low Noise, Low Power, 3 wire Up/Down, 32 Taps

The Intersil X93156 is a three-terminal digitally controlled potentiometer (XDCP). The device consists of a resistor array, wiper switches, a control section, and nonvolatile memory. The wiper position is controlled by an Up/Down interface.

The potentiometer is implemented by a resistor array composed of 31 resistive elements and a wiper switching network. The position of the wiper element is controlled by the \overline{CS} , U/\overline{D} , and \overline{INC} inputs. The position of the wiper can be stored in a nonvolatile memory and then be recalled upon a subsequent power-up operation.

The device can be used as a three-terminal potentiometer or as a two terminal variable resistor in a wide variety of applications including the programming of bias voltages, LCD brightness and contrast control as well as the implementation of ladder networks.

Features

- Solid-state potentiometer
- Up/Down interface
- 32 wiper tap points
 - Wiper position stored in nonvolatile memory and recalled on power-up
- 31 resistive elements
 - Temperature compensated
 - Maximum resistance tolerance of $\pm 25\%$
 - Terminal voltage, 0 to V_{CC}
- Low power CMOS
 - $V_{CC} = 2.7V$ to $5.5V$
 - Active current, $200\mu A$ typ.
 - Standby current, $2\mu A$ max.
- High reliability
 - Endurance 200,000 data changes per bit
 - Register data retention, 100 years
- R_{TOTAL} value = $12.5k\Omega$, $50k\Omega$
- Package
 - 8 Ld MSOP
 - Pb-free Available (RoHS compliant)

Pinout

X93156
(8 LD MSOP)
TOP VIEW

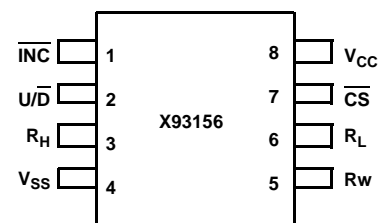

Ordering Information

PART NUMBER	PART MARKING	V _{CC} RANGE (V)	R _{TOTAL} (kΩ)	TEMP RANGE (°C)	PACKAGE	PKG. DWG. #
X93156WM8I	AGO	5 ±10%	12.5	-40 to +85	8 Ld MSOP	M8.118
X93156WM8I-2.7*	AGR	2.7 to 5.5	12.5	-40 to +85	8 Ld MSOP	M8.118
X93156UM8I-2.7*	AGP	2.7 to 5.5	50	-40 to +85	8 Ld MSOP	M8.118
X93156WM8IZ-2.7* (Note)	DCK	2.7 to 5.5	12.5	-40 to +85	8 Ld MSOP (Pb-free)	M8.118
X93156UM8IZ-2.7* (Note)	AKV	2.7 to 5.5	50	-40 to +85	8 Ld MSOP (Pb-free)	M8.118
X93156WM8IZ	DCJ	5 ±10%	12.5	-40 to +85	8 Ld MSOP (Pb-free)	M8.118

*Add "-T1" suffix for tape and reel. Please refer to TB347 for details on reel specifications.

NOTE: These Intersil Pb-free plastic packaged products employ special Pb-free material sets; molding compounds/die attach materials and 100% matte tin plate PLUS ANNEAL - e3 termination finish, which is RoHS compliant and compatible with both SnPb and Pb-free soldering operations. Intersil Pb-free products are MSL classified at Pb-free peak reflow temperatures that meet or exceed the Pb-free requirements of IPC/JEDEC J STD-020.

Block Diagram

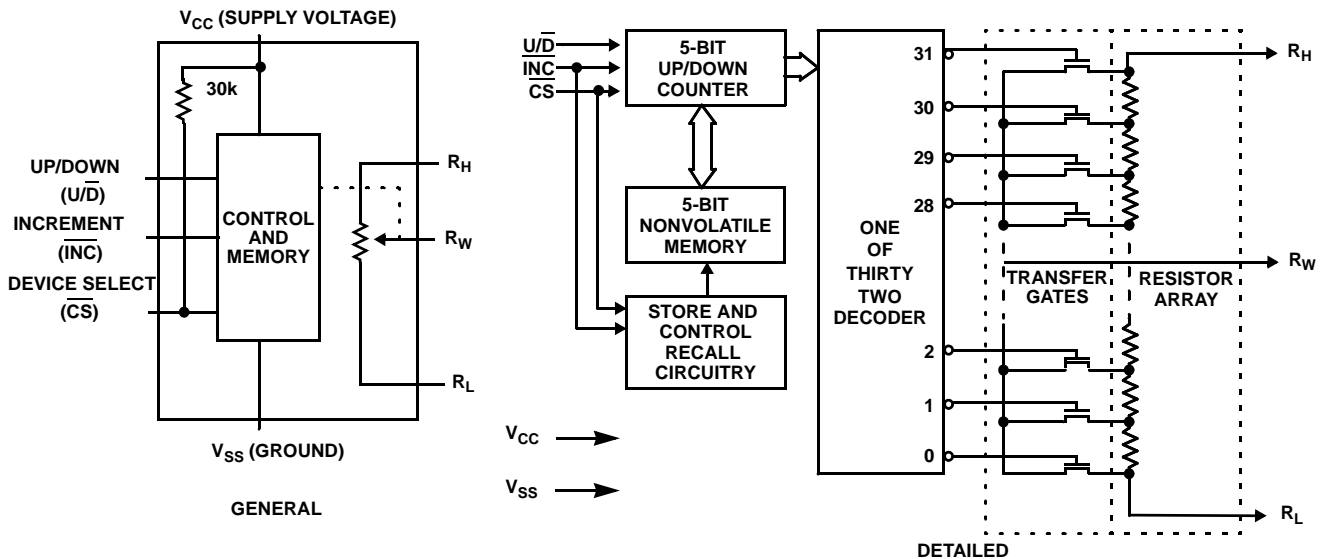

Pin Descriptions

MSOP	SYMBOL	BRIEF DESCRIPTION
1	INC	Increment (INC). The INC input is negative-edge triggered. Toggling INC will move the wiper and either increment or decrement the counter in the direction indicated by the logic level on the U/D input.
2	U/D	Up/Down (U/D). The U/D input controls the direction of the wiper movement and whether the counter is incremented or decremented.
3	R _H	R_H. The R _H and R _L pins of the X93156 are equivalent to the fixed terminals of a mechanical potentiometer. The minimum voltage is V _{SS} and the maximum is V _{CC} . The terminology of R _H and R _L references the relative position of the terminal in relation to wiper movement direction selected by the U/D input.
4	V _{SS}	Ground.
5	R _w	R_w. The R _w pin of the X93156 is the wiper terminal of the potentiometer which is equivalent to the movable terminal of a mechanical potentiometer.
6	R _L	R_L. The R _H and R _L pins of the X93156 are equivalent to the fixed terminals of a mechanical potentiometer. The minimum voltage is V _{SS} and the maximum is V _{CC} . The terminology of R _H and R _L references the relative position of the terminal in relation to wiper movement direction selected by the U/D input.
7	CS	Chip Select (CS). The device is selected when the CS input is LOW. The current counter value is stored in nonvolatile memory when CS is returned HIGH while the INC input is also HIGH. After the store operation is complete, the X93156 will be placed in the low power standby mode until the device is selected once again.
8	V _{CC}	Supply Voltage.

Absolute Maximum Ratings

Temperature under bias -65°C to +135°C
 Storage temperature -65°C to +150°C
 Voltage on CS, INC, U/D, RH, RL and V_{CC}
 with respect to V_{SS} -1V to +6.5V
 Maximum resistor current 2mA

Thermal Information

Thermal Resistance (Typical, Note 1) θ_{JA} (°C/W)
 8 Ld MSOP. 190
 Pb-free reflow profile see link below
<http://www.intersil.com/pbfree/Pb-FreeReflow.asp>

Recommended Operating Conditions

Temperature Range
 Industrial. -40°C to +85°C
 Supply Voltage V_{CC}
 X93156xxx-2.7 2.7V to 5.5V (Note 8)
 X93156xxx5V ±10%

CAUTION: Do not operate at or near the maximum ratings listed for extended periods of time. Exposure to such conditions may adversely impact product reliability and result in failures not covered by warranty.

NOTE:

1. θ_{JA} is measured with the component mounted on a high effective thermal conductivity test board in free air. See Tech Brief TB379 for details.

Potentiometer Specifications Over recommended operating conditions unless otherwise stated.

SYMBOL	PARAMETER	TEST CONDITIONS/NOTES	MIN (Note 9)	TYP	MAX (Note 9)	UNIT
R _{TOT}	End to end resistance		9.375	12.5	15.625	kΩ
			37.5	50	62.5	kΩ
V _R	R _H , R _L terminal voltages		0		V _{CC}	V
	Power rating	(Note 7)			1	mW
	Noise	Ref: 1kHz (Note 7)		-120		dBV
R _W	Wiper Resistance				1100	Ω
I _W	Wiper Current	(Note 6)			±0.6	mA
	Resolution			3		%
	Absolute linearity (Note 2)	V _{H(n)(actual)} - V _{H(n)(expected)} (Note 4)			±1	MI
	Relative linearity (Note 3)	V _{H(n+1)} - [V _{H(n)} + MI] (Note 4)			±0.5	MI
	R _{TOTAL} temperature coefficient	(Note 7)		±35		ppm/°C
C _H /C _L /C _W	Potentiometer capacitances	See circuit #2 (Note 7)		10/10/25		pF

DC Electrical Specifications Over recommended operating conditions unless otherwise specified.

SYMBOL	PARAMETER	TEST CONDITIONS	MIN (Note 9)	TYP (Note 5)	MAX (Note 9)	UNIT
I _{CC1}	V _{CC} active current (Increment)	$\overline{CS} = V_{IL}$, $U/\overline{D} = V_{IL}$ or V_{IH} and $\overline{INC} = 0.4V$ @ max. t _{CYC} V _{CC} = 3V		50	250	μA
		$\overline{CS} = V_{IL}$, $U/\overline{D} = V_{IL}$ or V_{IH} and $\overline{INC} = 0.4V$ @ max. t _{CYC} V _{CC} = 5V		200	300	μA
I _{CC2}	V _{CC} active current (Store) (EEPROM Store)	$\overline{CS} = V_{IH}$, $U/\overline{D} = V_{IL}$ or V_{IH} and $\overline{INC} = V_{IH}$ @ max. t _{WR} V _{CC} = 3V			600	μA
		$\overline{CS} = V_{IH}$, $U/\overline{D} = V_{IL}$ or V_{IH} and $\overline{INC} = V_{IH}$ @ max. t _{WR} V _{CC} = 5V			1400	μA
I _{SB}	Standby supply current	$\overline{CS} = V_{CC} - 0.3V$, U/\overline{D} and $\overline{INC} = V_{SS}$ or V _{CC} - 0.3V V _{CC} = 3V			1	μA
		$\overline{CS} = V_{CC} - 0.3V$, U/\overline{D} and $\overline{INC} = V_{SS}$ or V _{CC} - 0.3V V _{CC} = 5V			2	μA
I _{LI}	CS input leakage current	V _{IN} = V _{CC}			±1	μA

DC Electrical Specifications Over recommended operating conditions unless otherwise specified. (Continued)

SYMBOL	PARAMETER	TEST CONDITIONS	MIN (Note 9)	TYP (Note 5)	MAX (Note 9)	UNIT
I _{LI}	CS input leakage current	V _{CC} = 3V, $\overline{CS} = 0$	60	100	150	μA
I _{LI}	CS input leakage current	V _{CC} = 5V, $\overline{CS} = 0$	120	200	250	μA
I _{LI}	\overline{INC} , U/ \overline{D} input leakage current	V _{IN} = V _{SS} to V _{CC}			±1	μA
V _{IH}	\overline{CS} , \overline{INC} , U/ \overline{D} input HIGH voltage		V _{CC} × 0.7		V _{CC} + 0.5	V
V _{IL}	\overline{CS} , \overline{INC} , U/ \overline{D} input LOW voltage		-0.5		V _{CC} × 0.1	V
C _{IN} (Notes 7, 8)	\overline{CS} , \overline{INC} , U/ \overline{D} input capacitance	V _{CC} = 3V, V _{IN} = V _{SS} , T _A = +25°C, f = 1MHz			10	pF

NOTES:

- Absolute linearity is utilized to determine actual wiper voltage versus expected voltage = (V_{H(n)}(actual)-V_{H(n)}(expected)) = ±1 MI Maximum. n = 1.. 29 only
- Relative linearity is a measure of the error in step size between taps = V_{H(n+1)} - [V_{H(n)} + MI] = ±0.5 MI, n = 1 .. 29 only.
- 1 MI = Minimum Increment = R_{TOT}/31.
- Typical values are for T_A = +25°C and nominal supply voltage.
- This parameter is periodically sampled and not 100% tested
- This parameter is not 100% tested.
- When performing multiple write operations, V_{CC} must not decrease by more than 150mV from it's initial value.
- Parts are 100% tested at +25°C. Over-temperature limits established by characterization and are not production tested.

Endurance and Data Retention

PARAMETER	MIN	UNIT
Minimum endurance	200,000	Data changes per bit
Data retention	100	Years

Test Circuit #1

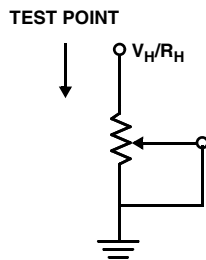

Circuit #2 SPICE Macro Model

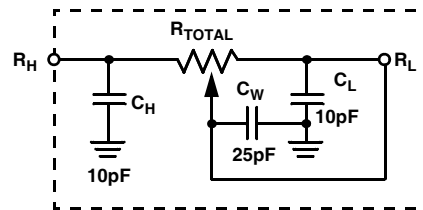

AC Conditions of Test

Input pulse levels	0V to 3V
Input rise and fall times	10ns
Input reference levels	1.5V

AC Electrical Specifications Over recommended operating conditions unless otherwise specified.

SYMBOL	PARAMETER	MIN	TYP	MAX	UNIT
t _{CI}	\overline{CS} to \overline{INC} setup	100			ns
t _{ID}	\overline{INC} HIGH to U/ \overline{D} change	100			ns
t _{DI}	U/ \overline{D} to \overline{INC} setup	100			ns
t _{IL}	\overline{INC} LOW period	1			μs
t _{IH}	\overline{INC} HIGH period	1			μs
t _{IC}	\overline{INC} Inactive to \overline{CS} inactive	1			μs
t _{CPH}	\overline{CS} Deselect time (NO STORE)	250			ns
t _{CPH}	\overline{CS} Deselect time (STORE)	10			ms
t _{CYC}	\overline{INC} cycle time	2			μs

AC Electrical Specifications Over recommended operating conditions unless otherwise specified. (Continued)

SYMBOL	PARAMETER	MIN	TYP	MAX	UNIT
t_R, t_F (Note 7)	\overline{INC} input rise and fall time			500	μs
$t_R V_{CC}$ (Note 7)	V_{CC} power-up rate	0.2		50	V/ms
t_{WR}	Store cycle		5	10	ms

AC Timing

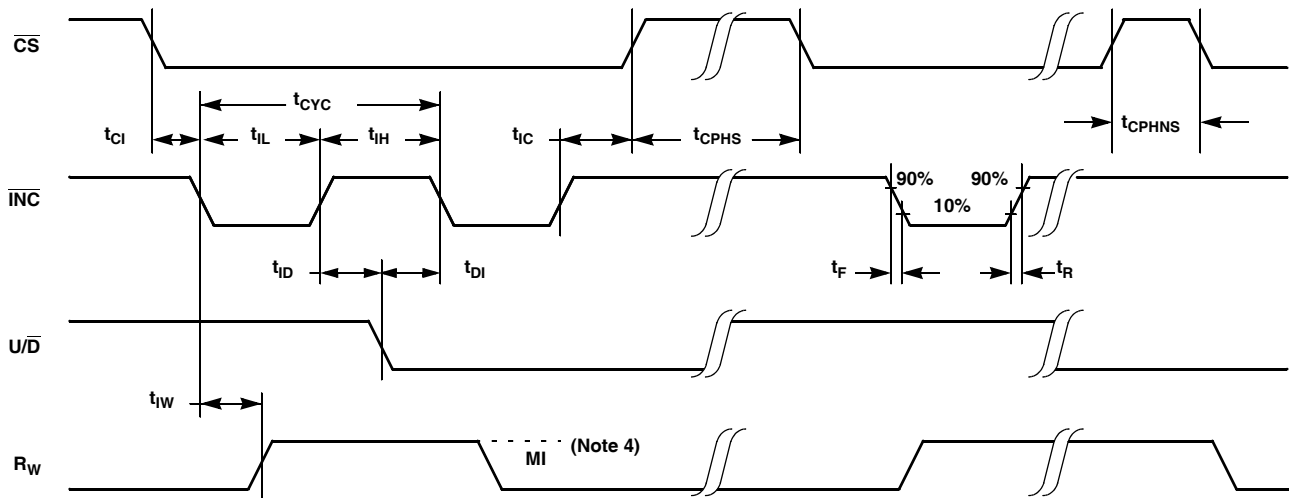

Power-Up and Down Requirements

There are no restrictions on the power-up or power-down conditions of V_{CC} and the voltages applied to the potentiometer pins provided that V_{CC} is always more positive than or equal to V_H and V_L , i.e., $V_{CC} \geq V_H, V_L$. The V_{CC} ramp rate spec is always in effect.

Pin Descriptions

R_H and R_L

The R_H and R_L pins of the X93156 are equivalent to the fixed terminals of a mechanical potentiometer. The minimum voltage is V_{SS} and the maximum is V_{CC} . The terminology of R_H and R_L references the relative position of the terminal in relation to wiper movement direction selected by the U/\overline{D} input.

R_W

The R_W pin of the X93156 is the wiper terminal of the potentiometer which is equivalent to the movable terminal of a mechanical potentiometer.

Up/Down (U/\overline{D})

The U/\overline{D} input controls the direction of the wiper movement and whether the counter is incremented or decremented.

Increment (\overline{INC})

The \overline{INC} input is negative-edge triggered. Toggling \overline{INC} will move the wiper and either increment or decrement the counter in the direction indicated by the logic level on the U/\overline{D} input.

Chip Select (\overline{CS})

The device is selected when the \overline{CS} input is LOW. The current counter value is stored in nonvolatile memory when \overline{CS} is returned HIGH while the \overline{INC} input is also HIGH. After the store operation is complete the X93156 will be placed in the low power standby mode until the device is selected once again.

Principles of Operation

There are three sections of the X93156: the input control, counter and decode section; the nonvolatile memory; and the resistor array. The input control section operates just like an up/down counter. The output of this counter is decoded to turn on a single electronic switch connecting a point on the resistor array to the wiper output. Under the proper conditions the contents of the counter can be stored in nonvolatile memory and retained for future use. The resistor array is comprised of 31 individual resistors connected in series. At either end of the array and between each resistor is an electronic switch that transfers the connection at that point to the wiper.

The wiper, when at either fixed terminal, acts like its mechanical equivalent and does not move beyond the last position. That is, the counter does not wrap around when clocked to either extreme.

If the wiper is moved several positions, multiple taps are connected to the wiper for t_{IW} (\overline{INC} to V_W change). The 2-terminal resistance value for the device can temporarily change by a significant amount if the wiper is moved several positions.

When the device is powered-down, the last wiper position stored will be maintained in the nonvolatile memory. When power is restored, the contents of the memory are recalled and the wiper is set to the value last stored.

Instructions and Programming

The \overline{INC} , $\overline{U/D}$ and \overline{CS} inputs control the movement of the wiper along the resistor array. With \overline{CS} set LOW the device is selected and enabled to respond to the $\overline{U/D}$ and \overline{INC} inputs. HIGH to LOW transitions on \overline{INC} will increment or decrement (depending on the state of the $\overline{U/D}$ input) a five bit counter. The output of this counter is decoded to select one of thirty two wiper positions along the resistive array.







The value of the counter is stored in nonvolatile memory whenever \overline{CS} transitions HIGH while the \overline{INC} input is also HIGH. In order to avoid an accidental store during power-up, \overline{CS} must go HIGH with V_{CC} during initial power-up. When left open, the \overline{CS} pin is internally pulled up to V_{CC} by an internal 30k resistor.

The system may select the X93156, move the wiper and deselect the device without having to store the latest wiper position in nonvolatile memory. After the wiper movement is performed as described above and once the new position is reached, the system must keep \overline{INC} LOW while taking \overline{CS} HIGH. The new wiper position will be maintained until changed by the system or until a power-up/down cycle recalled the previously stored data. In order to recall the stored position of the wiper on power-up, the \overline{CS} pin must be held HIGH.





This procedure allows the system to always power-up to a preset value stored in nonvolatile memory; then during system operation minor adjustments could be made. The adjustments might be based on user preference, system parameter changes due to temperature drift, or other system trim requirements.

The state of $\overline{U/D}$ may be changed while \overline{CS} remains LOW. This allows the host system to enable the device and then move the wiper up and down until the proper trim is attained.

Mode Selection

\overline{CS}	\overline{INC}	$\overline{U/D}$	MODE
L		H	Wiper Up
L		L	Wiper Down
	H	X	Store Wiper Position
H	X	X	Standby Current
	L	X	No Store, Return to Standby
	L	H	Wiper Up (not recommended)
	L	L	Wiper Down (not recommended)

Symbol Table

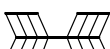
WAVEFORM	INPUTS	OUTPUTS
	Must be steady	Will be steady
	May change from Low to High	Will change from Low to High
	May change from High to Low	Will change from High to Low
	Don't Care: Changes Allowed	Changing: State Not Known
	N/A	Center Line is High Impedance

Mini Small Outline Plastic Packages (MSOP)

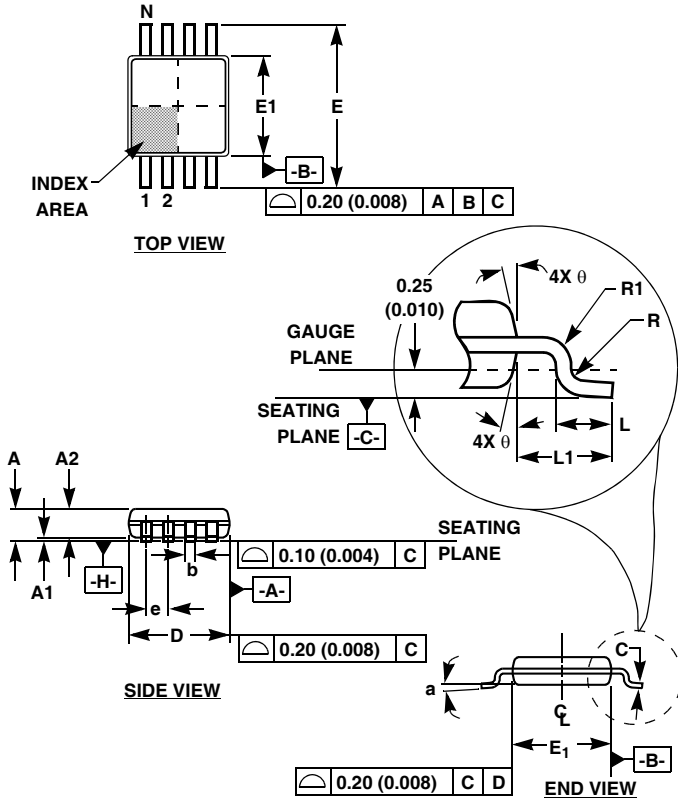

M8.118 (JEDEC MO-187AA)
8 LEAD MINI SMALL OUTLINE PLASTIC PACKAGE

SYMBOL	INCHES		MILLIMETERS		NOTES
	MIN	MAX	MIN	MAX	
A	0.037	0.043	0.94	1.10	-
A1	0.002	0.006	0.05	0.15	-
A2	0.030	0.037	0.75	0.95	-
b	0.010	0.014	0.25	0.36	9
c	0.004	0.008	0.09	0.20	-
D	0.116	0.120	2.95	3.05	3
E1	0.116	0.120	2.95	3.05	4
e	0.026 BSC		0.65 BSC		-
E	0.187	0.199	4.75	5.05	-
L	0.016	0.028	0.40	0.70	6
L1	0.037 REF		0.95 REF		-
N	8		8		7
R	0.003	-	0.07	-	-
R1	0.003	-	0.07	-	-
θ	5°	15°	5°	15°	-
α	0°	6°	0°	6°	-

Rev. 2 01/03

NOTES:

- These package dimensions are within allowable dimensions of JEDEC MO-187BA.
- Dimensioning and tolerancing per ANSI Y14.5M-1994.
- Dimension "D" does not include mold flash, protrusions or gate burrs and are measured at Datum Plane. Mold flash, protrusion and gate burrs shall not exceed 0.15mm (0.006 inch) per side.
- Dimension "E1" does not include interlead flash or protrusions and are measured at Datum Plane. [-H-] Interlead flash and protrusions shall not exceed 0.15mm (0.006 inch) per side.
- Formed leads shall be planar with respect to one another within 0.10mm (0.004) at seating Plane.
- "L" is the length of terminal for soldering to a substrate.
- "N" is the number of terminal positions.
- Terminal numbers are shown for reference only.
- Dimension "b" does not include dambar protrusion. Allowable dambar protrusion shall be 0.08mm (0.003 inch) total in excess of "b" dimension at maximum material condition. Minimum space between protrusion and adjacent lead is 0.07mm (0.0027 inch).
- Datums [-A-] and [-B-] to be determined at Datum plane [-H-].
- Controlling dimension: MILLIMETER. Converted inch dimensions are for reference only.

All Intersil U.S. products are manufactured, assembled and tested utilizing ISO9000 quality systems. Intersil Corporation's quality certifications can be viewed at www.intersil.com/design/quality

Intersil products are sold by description only. Intersil Corporation reserves the right to make changes in circuit design, software and/or specifications at any time without notice. Accordingly, the reader is cautioned to verify that data sheets are current before placing orders. Information furnished by Intersil is believed to be accurate and reliable. However, no responsibility is assumed by Intersil or its subsidiaries for its use; nor for any infringements of patents or other rights of third parties which may result from its use. No license is granted by implication or otherwise under any patent or patent rights of Intersil or its subsidiaries.

For information regarding Intersil Corporation and its products, see www.intersil.com