

# AMMP-6130

## 30 GHz Power Amplifier with Frequency Multiplier (x2) in SMT Package

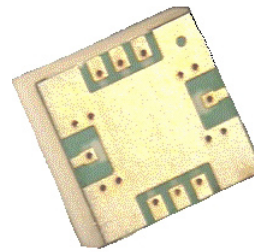

### Data Sheet



#### Description

Avago Technologies AMMP-6130 is a high gain, narrow-band doubler and output power amplifier designed for DBS applications and other commercial communication systems. The MMIC takes an input 15 GHz signal and passes it through a harmonic frequency multiplier (x2) and then three stages of power amplification. Integrated matching structures filter and match input/output to 50 Ω. It has integrated input and output DC blocking capacitors and bias structures to all stages. The MMIC is fabricated using PHEMT technology. The backside of this package part is both RF and DC ground. This helps simplify the assembly process and reduces assembly related performance variations and costs. The surface mount package allows elimination of “chip & wire” assembly for lower cost. This MMIC is a cost effective alternative to hybrid (discrete-FET) amplifiers that require complex tuning and assembly process.

#### Pin Connections (Top View)

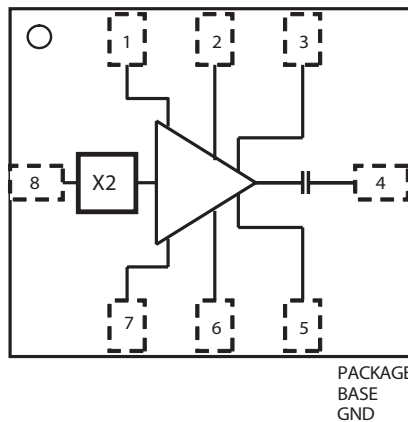

Pin	Function
1	
2	V <sub>d</sub>
3	
4	RF <sub>Out</sub>
5	
6	
7	
8	RF <sub>In</sub>

#### Features

- Surface Mount Package, 5.0 x 5.0 x 1.25 mm
- Integrated DC Block and Choke
- 50 Ω Input and Output Match
- Single Positive Supply Pin
- No Negative Gate Bias

#### Specifications (V<sub>d</sub>=4.5V, I<sub>dd</sub>=200mA)

- Frequency Range 15GHz in, 30GHz out
- Output Power: 21 dBm
- Harmonic Suppression: 60dBc
- Single Positive Supply
- DC Requirements: 4.5V, 200mA

#### Applications

- Microwave Radio systems
- Satellite VSAT, DBS Up/Down Link
- Broadband Wireless Access)



Note: These devices are ESD sensitive. The following precautions are strongly recommended. Ensure that an ESD approved carrier is used when units are transported from one destination to another. Personal grounding is to be worn at all times when handling these devices. The manufacturer assumes no responsibilities for ESD damage due to improper storage and handling of these devices.

### Absolute Maximum Ratings (1)

Sym	Parameters/Condition	Unit	Max
Vdd	Drain to Ground Voltage	V	5
Idd	Drain Current	mA	300
Pin	RF CW Input Power Max	dBm	15
Tch	Max channel temperature	C	+150
Tstg	Storage temperature	C	-65 +150
Tmax	Maximum Assembly Temp	C	260 for 20s

Notes.

1. Operation in excess of any of these conditions may result in permanent damage to this device. The absolute maximum ratings for Vdd, Idd and Pin were determined at an ambient temperature of 25°C unless noted otherwise.

### DC Specifications/ Physical Properties (2)

Sym	Parameter and Test Condition	Unit	Min	Typ	Max
Idd	Drain Supply Current under any RF power drive and temp.(V <sub>d</sub> =4.5 V)	mA		200	250
Vd	Drain Supply Voltage	V	3.5	4.5	5
θ <sub>jc</sub>	Thermal Resistance <sup>(3)</sup>	C/W		45	

2. Ambient operational temperature TA=25°C unless noted

3. Channel-to-backside Thermal Resistance (T<sub>channel</sub> = 34°C) as measured using infrared microscopy. Thermal Resistance at backside temp. (T<sub>b</sub>) = 25°C calculated from measured data.

### AMMP-6130 RF Specifications (4,5)

TA= 25°C, Vdd = 4.5 V, Idd = 200mA, Zo=50 Ω, Pin=5dBm

Symbol	Parameters and Test Conditions	Frequency	Units	Minimum	Maximum	Typical
Freq	Operational Frequency		GHz			30
Gain	Conversion Gain <sup>(4,5)</sup>	30	dB	14	18.5	16
Pout	Output Power <sup>(5)</sup>	30	dBm	19	23.5	21
FS	Fundamental Suppression	30	dBc			60
3H Sup	3rd Harmonic Suppression		dBc			50

Notes.

4. Small/Large -signal data measured in a fully de-embedded test fixture form TA = 25°C.
5. All tested parameters guaranteed with measurement accuracy +/-1dB/dBm/dBc.

### Typical Distribution of Conversion Gain and Output Power based on 1000 parts

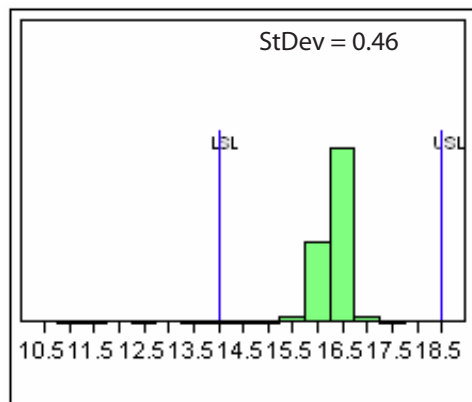

Conversion Gain at 30GHz

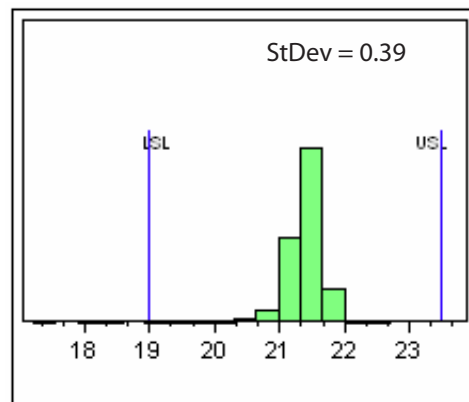

Output Power at 30GHz

# AMMP-6130 Typical Performance

(TA = 25°C, Vdd=4.5V, Idd=200 mA, Zin = Zout = 50Ω, Pin=3dBm unless otherwise stated)

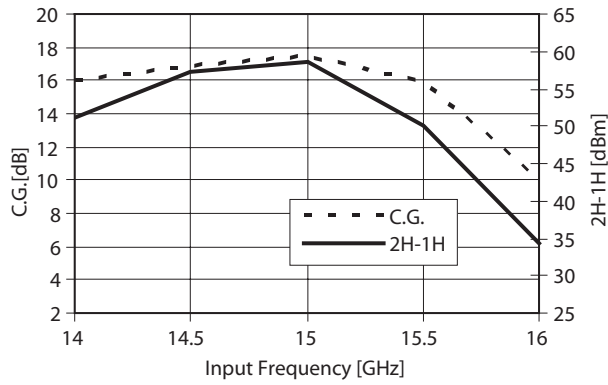

Figure 1. Conversion Gain & Fundamental Sup vs. Input Freq

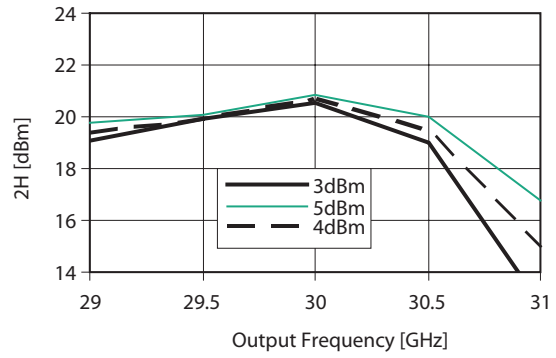

Figure 2. Output Power vs. Output Frequency vs. Input Power

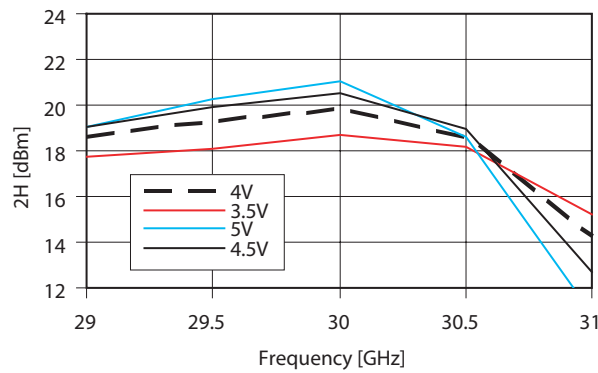

Figure 3. Output Power vs. Output Frequency @ 4 bias levels

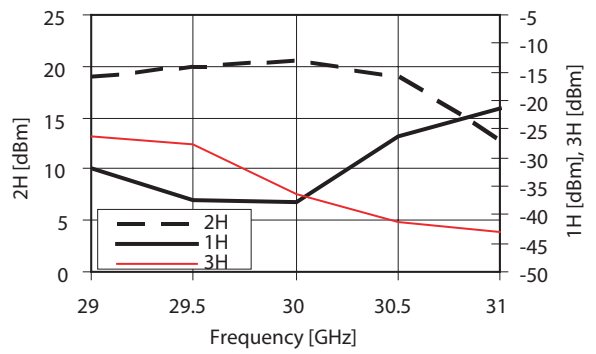

Figure 4. Fundamental, 2H & 3H Output Power vs. Output Freq

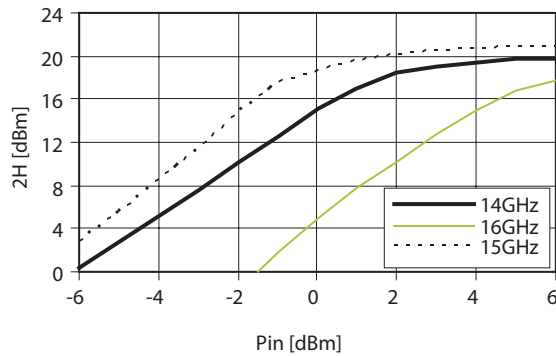

Figure 5. Output Power vs. Input Power vs. Input Freq

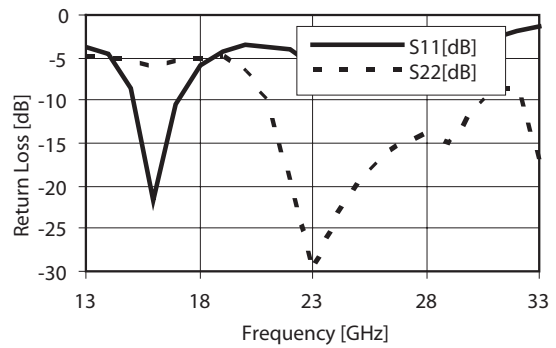

Figure 6. Input and Output Return Loss vs. Freq

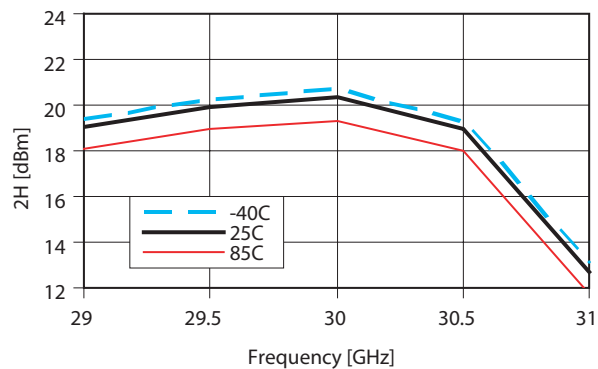

Figure 7. Output Power vs. Output Freq @ Temp = 25C, -40C & 85C

## Typical Scattering Parameters [1]

(TA = 25°C, Vdd = 4.5 V, IDD = 200 mA, Zin = Zout = 50 Ω)

Freq	S11			S21			S12			S22		
	GHz	dB	Mag	Phase	dB	Mag	Phase	dB	Mag	Phase	dB	Mag
1	-2.166	0.779	73.909	-80.000	0.000	32.383	-76.478	0.000	96.570	-0.425	0.952	-101.410
2	-2.531	0.747	-33.368	-55.139	0.002	131.860	-64.437	0.001	14.797	-1.765	0.816	159.979
3	-3.497	0.669	-148.095	-47.131	0.004	4.147	-60.915	0.001	-81.506	-3.270	0.686	61.101
4	-4.889	0.570	81.765	-35.890	0.016	-149.666	-61.938	0.001	-167.459	-6.891	0.452	-23.500
5	-4.747	0.579	-58.704	-39.659	0.010	14.517	-76.478	0.000	-43.361	-5.259	0.546	-102.375
6	-4.158	0.620	177.213	-42.499	0.008	-90.973	-60.000	0.001	179.115	-5.923	0.506	170.014
7	-3.851	0.642	65.073	-40.491	0.009	125.799	-52.217	0.002	90.638	-6.641	0.466	79.202
8	-3.490	0.669	-47.052	-38.202	0.012	6.552	-50.903	0.003	-0.484	-7.851	0.405	-19.043
9	-2.858	0.720	-152.082	-36.449	0.015	127.728	-51.213	0.003	-66.346	-8.101	0.394	-114.956
10	-2.405	0.758	115.491	-39.453	0.011	-65.533	-50.752	0.003	-143.716	-7.230	0.435	158.758
11	-2.455	0.754	30.433	-36.924	0.014	-163.279	-51.057	0.003	143.963	-6.848	0.455	78.557
12	-3.151	0.696	-60.545	-31.920	0.025	107.046	-51.701	0.003	70.767	-7.764	0.409	-2.902
13	-4.322	0.608	-169.451	-25.739	0.052	3.617	-53.351	0.002	-5.502	-9.863	0.321	-100.642
14	-4.834	0.573	73.490	-21.180	0.087	-117.593	-56.773	0.001	-76.081	-9.730	0.326	143.433
15	-8.532	0.471	-34.070	-18.548	0.118	110.391	-58.416	0.001	-115.604	-7.355	0.429	47.561
16	-17.084	0.140	178.992	-17.566	0.132	6.543	-55.139	0.002	176.951	-6.539	0.471	-30.885
17	-4.491	0.596	-53.423	-17.635	0.131	-135.344	-54.895	0.002	114.486	-7.803	0.407	-107.509
18	-3.044	0.704	-155.503	-23.293	0.068	136.100	-55.918	0.002	53.047	-10.664	0.293	152.353
19	-3.366	0.679	102.797	-18.655	0.117	95.071	-55.650	0.002	10.720	-9.247	0.345	7.160
20	-3.044	0.704	-9.051	-9.450	0.337	-14.777	-50.604	0.003	-48.544	-6.265	0.486	-113.148
21	-2.867	0.719	-108.593	-5.991	0.502	-145.395	-48.068	0.004	-132.798	-11.811	0.257	132.293
22	-3.422	0.674	162.205	-4.028	0.629	82.328	-48.291	0.004	150.079	-13.966	0.200	-67.065
23	-4.695	0.582	63.767	-3.379	0.678	-39.850	-47.033	0.004	77.624	-10.858	0.287	-171.437
24	-4.668	0.584	-51.945	-2.061	0.789	-163.461	-49.119	0.004	-14.763	-13.856	0.203	116.377
25	-3.628	0.659	-154.450	-0.831	0.909	69.328	-54.425	0.002	-91.783	-26.366	0.048	37.539
26	-3.951	0.635	115.995	1.569	1.198	-59.027	-63.098	0.001	-133.605	-20.510	0.094	-161.333
27	-6.246	0.487	5.230	5.448	1.872	160.771	-54.425	0.002	-121.717	-14.933	0.179	150.560
28	-4.878	0.570	-139.262	8.677	2.716	0.554	-52.956	0.002	154.890	-13.580	0.209	94.577
29	-2.704	0.732	123.438	8.718	2.728	-161.843	-51.535	0.003	104.130	-19.160	0.110	112.029
30	-2.261	0.771	55.231	7.537	2.381	45.858	-44.883	0.006	33.927	-10.134	0.324	60.389
31	-2.438	0.755	-17.264	4.931	1.764	-99.661	-40.677	0.009	-92.384	-16.812	0.144	-33.753
32	-4.679	0.584	-129.407	2.021	1.262	124.211	-45.352	0.005	171.824	-12.958	0.225	93.604
33	-3.935	0.636	87.568	-2.173	0.779	-7.487	-47.639	0.004	82.835	-7.855	0.405	28.172
34	-2.625	0.739	-0.364	-3.950	0.635	-121.959	-54.425	0.002	29.124	-6.979	0.448	-23.046
35	-2.781	0.726	-54.324	-5.113	0.555	74.844	-51.213	0.003	24.686	-7.925	0.402	-70.880
36	-1.933	0.800	-110.128	-14.647	0.185	-47.149	-50.314	0.003	-44.356	-12.031	0.250	-120.006
37	-2.389	0.760	-179.000	-20.114	0.099	-142.199	-47.432	0.004	-103.624	-24.967	0.056	-83.063
38	-3.601	0.661	76.661	-23.728	0.065	119.631	-45.514	0.005	170.138	-11.511	0.266	-78.816
39	-3.147	0.696	-52.739	-29.776	0.032	19.317	-48.995	0.004	109.913	-8.394	0.380	-129.674
40	-2.535	0.747	-142.354	-37.109	0.014	-63.508	-48.636	0.004	59.709	-8.793	0.363	175.556

Note:

Data obtained off of a connectorized module

## Biasing and Operation

The AMMP-6130 frequency doubler has been designed with a fully integrated self bias network; thus, requiring only a single 4.5v bias input with a typical current draw of 200mA.

The one-stage frequency doubler relies on the non-linear behavior of the FET to produce the doubled signal at the output. A high-pass filter at the input shorts any reflected 2nd harmonic signal to ground. The input also consists of matching components tuned to 15GHz. An additional LC-filter is included at the input for stability. The doubler is operated at pinch-off to create a half-wave conduction angle ideal for generation of the 2nd harmonic. The AMMP-6130 is also designed for stability over temperature.

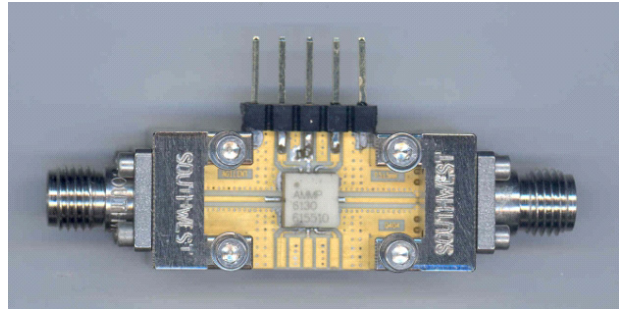

Figure 8. Evaluation / Test Board (Available to qualified customer requests)

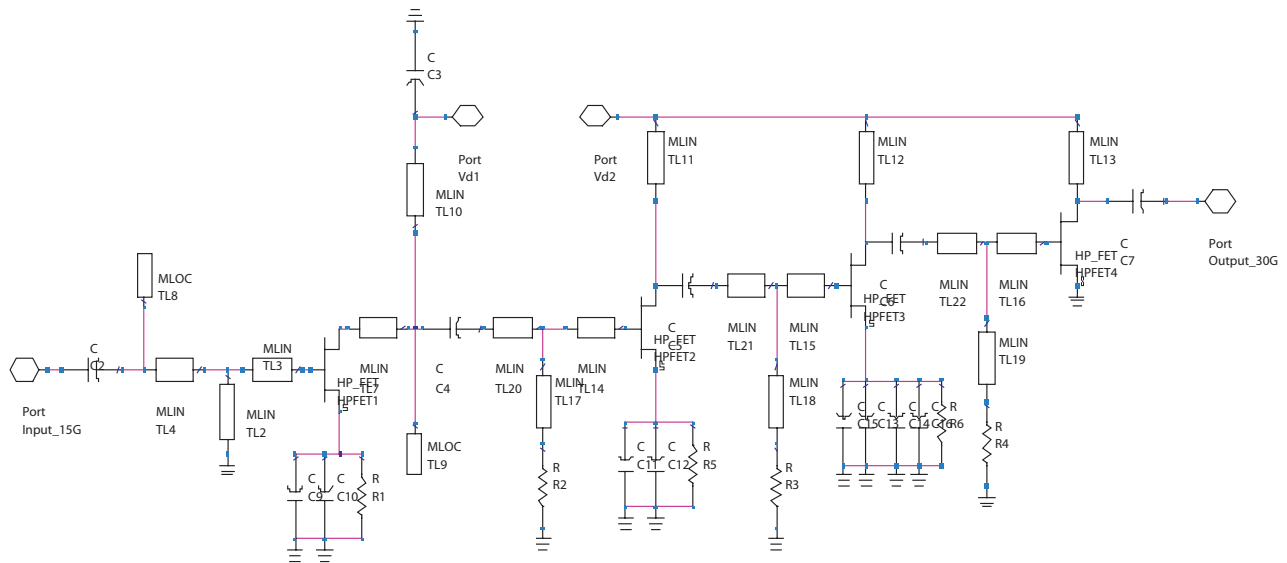

Figure 9. Simplified Doubler-Amplifier Schematic

## Recommended SMT Attachment for 5x5 Package

The AMMP Packaged Devices are compatible with high volume surface mount PCB assembly processes.

The PCB material and mounting pattern, as defined in the data sheet, optimizes RF performance and is strongly recommended. An electronic drawing of the land pattern is available upon request from Avago Sales & Application Engineering.

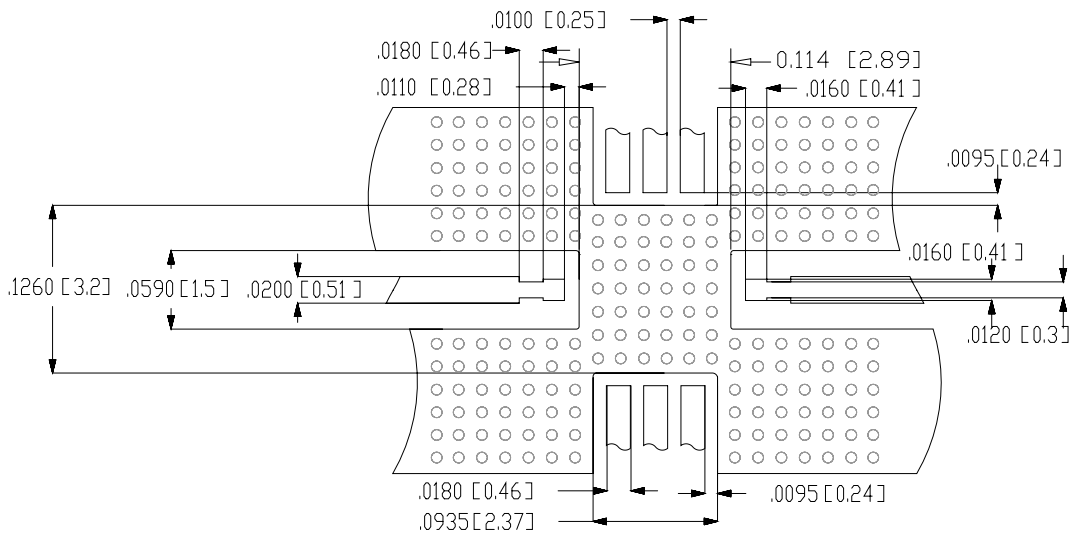

Figure 10a. Suggested PCB Land Pattern and Stencil Layout

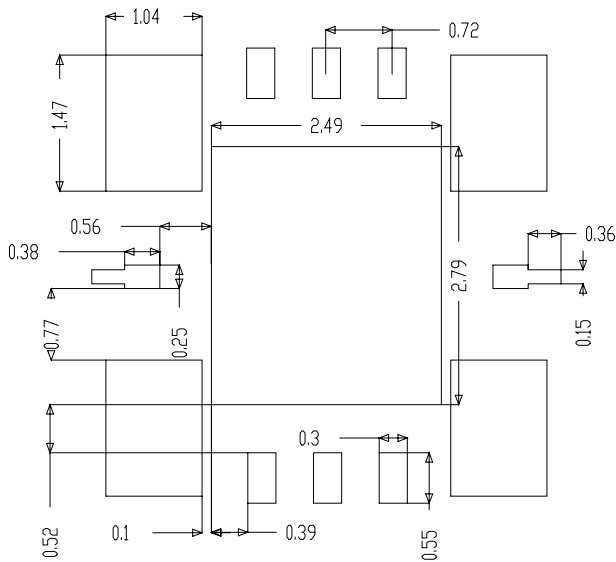

Figure 10b. Stencil Outline Drawing (mm)

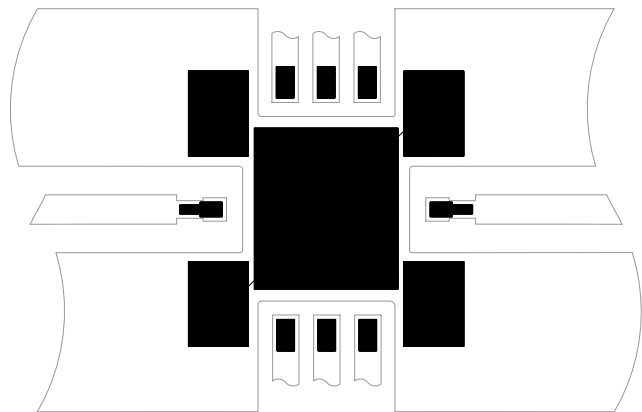

Figure 10c. Combined PCB and Stencil Layouts

## Manual Assembly

- Follow ESD precautions while handling packages.
- Handling should be along the edges with tweezers.
- Recommended attachment is conductive solder paste. Please see recommended solder reflow profile. Neither Conductive epoxy or hand soldering is recommended.
- Apply solder paste using a stencil printer or dot placement. The volume of solder paste will be dependent on PCB and component layout and should be controlled to ensure consistent mechanical and electrical performance.
- Follow solder paste and vendor's recommendations when developing a solder reflow profile. A standard profile will have a steady ramp up from room temperature to the pre-heat temp. to avoid damage due to thermal shock.
- Packages have been qualified to withstand a peak temperature of 260°C for 20 seconds. Verify that the profile will not expose device beyond these limits.

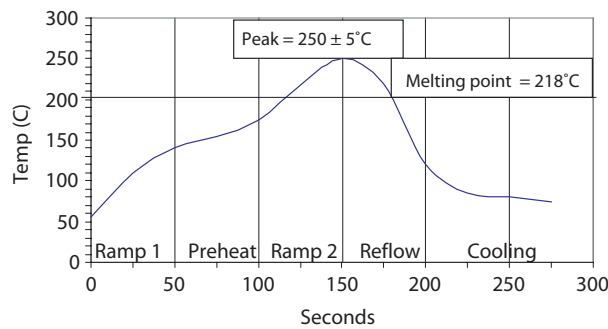
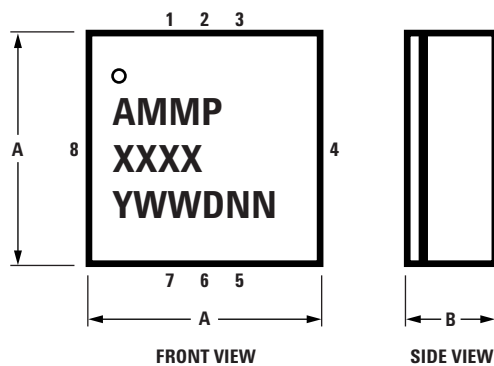

Figure 11. Suggested Lead-Free Reflow Profile for SnAgCu Solder Paste

## Package Dimensions



SYMBOL	MIN.	MAX.
A	0.198 (5.03)	0.213 (5.4)
B	0.0685 (1.74)	0.088 (2.25)

DIMENSIONS ARE IN INCHES (MM)

### NOTES:

1. \* INDICATES PIN 1
2. DIMENSIONS ARE IN INCHES (MILLIMETERS)
3. ALL GROUNDS MUST BE SOLDERED TO PCB RF GROUND

A properly designed solder screen or stencil is required to ensure optimum amount of solder paste is deposited onto the PCB pads. The recommended stencil layout is shown in Figure 8. The stencil has a solder paste deposition opening approximately 70% to 90% of the PCB pad. Reducing stencil opening can potentially generate more voids underneath. On the other hand, stencil openings larger than 100% will lead to excessive solder paste smear or bridging across the I/O pads. Considering the fact that solder paste thickness will directly affect the quality of the solder joint, a good choice is to use a laser cut stencil composed of 0.127mm (5 mils) thick stainless steel which is capable of producing the required fine stencil outline.

The most commonly used solder reflow method is accomplished in a belt furnace using convection heat transfer. The suggested reflow profile for automated reflow processes is shown in Figure 9. This profile is designed to ensure reliable finished joints. However, the profile indicated in Figure 1 will vary among different solder pastes from different manufacturers and is shown here for reference only.

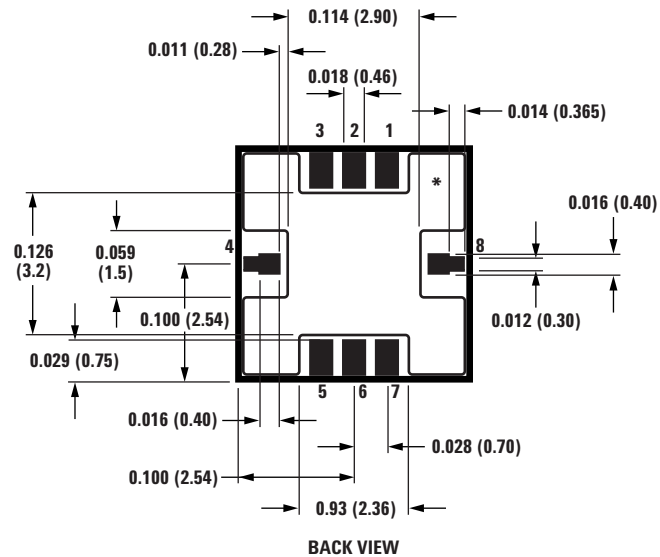

DIMENSIONAL TOLERANCE FOR BACK VIEW: 0.002" (0.05 mm)

## Carrier Tape and Pocket Dimensions

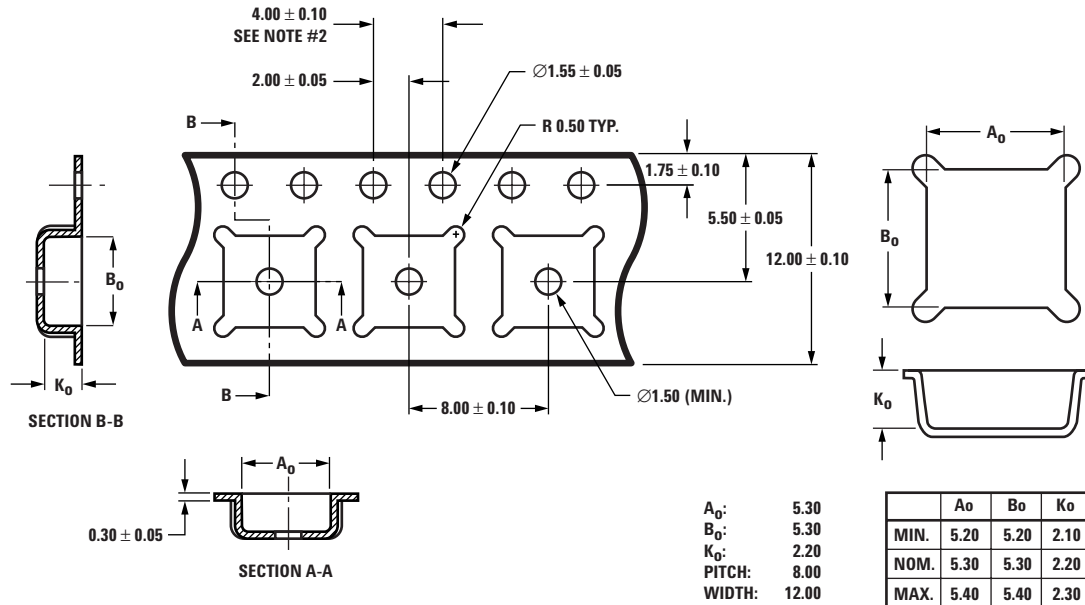

### NOTES:

1. A<sub>0</sub> AND B<sub>0</sub> MEASURED AT 0.3 mm ABOVE BASE OF POCKET.
2. 10 PITCHES CUMULATIVE TOLERANCE IS ± 0.2 mm.
3. DIMENSIONS ARE IN MILLIMETERS (mm).

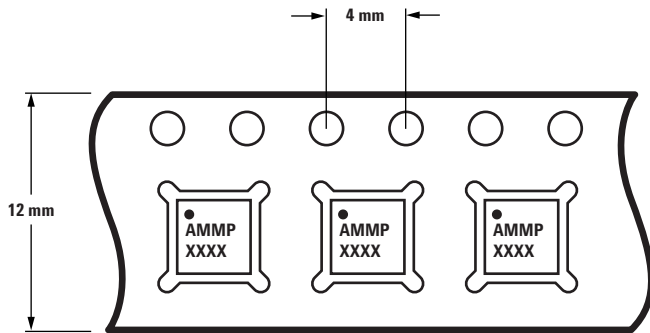

## AMMP-6130 Part Number Ordering Information

Part Number	Devices Per Container	Container
AMMP-6130-BLKG	10	Antistatic bag
AMMP-6130-TR1G	100	"7" Reel
AMMP-6130-TR2G	500	"7" Reel

**Note:** No RF performance degradation is seen due to ESD upto 250 V HBM and 80 V MM. The DC characteristics in general show increased leakage at lower ESD discharge voltages. The user is reminded that this device is ESD sensitive and needs to be handled with all necessary ESD protocols.

For product information and a complete list of distributors, please go to our web site:

[www.avagotech.com](http://www.avagotech.com)

Avago, Avago Technologies, and the A logo are trademarks of Avago Technologies, Limited in the United States and other countries. Data subject to change. Copyright © 2007 Avago Technologies Limited. All rights reserved. Obsoletes AV01-0287EN AV02-0514EN - June 14, 2007

**AVAGO**  
TECHNOLOGIES