

Absolute Maximum Ratings (Note 1)

If Military/Aerospace specified devices are required, please contact the National Semiconductor Sales Office/Distributors for availability and specifications.

Voltage on Any Pins except V_R
(referred to V^- pin)

(Note 2) 36V (Max)
(Note 3) -0.3V (Min)

Current through Any Input Pin &

V_R Pin ± 20 mA

Differential Input Voltage

LM614I ± 36 V
LM614C ± 32 V

Storage Temperature Range $-65^\circ\text{C} \leq T_J \leq +150^\circ\text{C}$
Maximum Junction Temperature 150°C
Thermal Resistance,
Junction-to-Ambient (Note 4) 150°C
Soldering Information (Soldering,
10 sec.) 220°C
ESD Tolerance (Note 5) ± 1 kV

Operating Temperature Range

LM614I $-40^\circ\text{C} \leq T_J \leq +85^\circ\text{C}$
LM614C $0^\circ\text{C} \leq T_J \leq +70^\circ\text{C}$

Electrical Characteristics

These specifications apply for $V^- = \text{GND} = 0\text{V}$, $V^+ = 5\text{V}$, $V_{\text{CM}} = V_{\text{OUT}} = 2.5\text{V}$, $I_R = 100\mu\text{A}$, FEEDBACK pin shorted to GND, unless otherwise specified. Limits in standard typeface are for $T_J = 25^\circ\text{C}$; limits in **Boldface type** apply over the **Operating Temperature Range**.

Symbol	Parameter	Conditions	Typ (Note 6)	LM614I LM614C Limits (Note 7)	Units
I_S	Total Supply Current	$R_{\text{LOAD}} = \infty$, $4\text{V} \leq V^+ \leq 36\text{V}$ (32V for LM614C)	450	1000	$\mu\text{A max}$
			550	1070	$\mu\text{A max}$
V_S	Supply Voltage Range		2.2	2.8	V min
			2.9	3	V min
			46	32	V max
			43	32	V max
OPERATIONAL AMPLIFIER					
V_{OS1}	V_{OS} Over Supply	$4\text{V} \leq V^+ \leq 36\text{V}$ ($4\text{V} \leq V^+ \leq 32\text{V}$ for LM614C)	1.5	5.0	mV max
			2.0	7.0	mV max
V_{OS2}	V_{OS} Over V_{CM}	$V_{\text{CM}} = 0\text{V}$ through $V_{\text{CM}} =$ ($V^+ - 1.8\text{V}$), $V^+ = 30\text{V}$	1.0	5.0	mV max
			1.5	7.0	mV max
$\frac{V_{\text{OS3}}}{\Delta T}$	Average V_{OS} Drift	(Note 7)	15		$\mu\text{V}/^\circ\text{C max}$
I_B	Input Bias Current		10	35	nA max
			11	40	nA max
I_{OS}	Input Offset Current		0.2	4	nA max
			0.3	5	nA max
$\frac{I_{\text{OS1}}}{\Delta T}$	Average Offset Drift Current		4		$\text{pA}/^\circ\text{C}$
R_{IN}	Input Resistance	Differential	1800		M Ω
		Common-Mode	3800		M Ω
C_{IN}	Input Capacitance	Common-Mode Input	5.7		pF
e_n	Voltage Noise	$f = 100$ Hz, Input Referred	74		$\text{nV}/\sqrt{\text{Hz}}$
I_n	Current Noise	$f = 100$ Hz, Input Referred	58		$\text{fA}/\sqrt{\text{Hz}}$
CMRR	Common-Mode Rejection Ratio	$V^+ = 30\text{V}$, $0\text{V} \leq V_{\text{CM}} \leq (V^+ - 1.8\text{V})$, CMRR = $20 \log (\Delta V_{\text{CM}}/\Delta V_{\text{OS}})$	95	75	dB min
			90	70	dB min
PSRR	Power Supply Rejection Ratio	$4\text{V} \leq V^+ \leq 30\text{V}$, $V_{\text{CM}} = V^+/2$, PSRR = $20 \log (\Delta V^+/\Delta V_{\text{OS}})$	110	75	dB min
			100	70	dB min

Electrical Characteristics (Continued)

These specifications apply for $V^- = \text{GND} = 0\text{V}$, $V^+ = 5\text{V}$, $V_{\text{CM}} = V_{\text{OUT}} = 2.5\text{V}$, $I_{\text{R}} = 100\mu\text{A}$, FEEDBACK pin shorted to GND, unless otherwise specified. Limits in standard typeface are for $T_{\text{J}} = 25^\circ\text{C}$; limits in **Boldface type** apply over the **Operating Temperature Range**.

Symbol	Parameter	Conditions	Typ (Note 6)	LM614 LM614C Limits (Note 7)	Units
A_V	Open Loop Voltage Gain	$R_L = 10\text{ k}\Omega$ to GND, $V^+ = 30\text{V}$, $5\text{V} \leq V_{\text{OUT}} \leq 25\text{V}$	500 50	94 40	V/mV min
SR	Slew Rate	$V^+ = 30\text{V}$ (Note 8)	± 0.70 ± 0.65	± 0.50 ± 0.45	V/ μs
GBW	Gain Bandwidth	$C_L = 50\text{ pF}$	0.8 0.52		MHz MHz
V_{O1}	Output Voltage Swing High	$R_L = 10\text{ k}\Omega$ to GND $V^+ = 36\text{V}$ (32V for LM614C)	$V^+ - 1.4$ $V^+ - 1.6$	$V^+ - 1.8$ $V^+ - 1.9$	V min V min
V_{O2}	Output Voltage Swing Low	$R_L = 10\text{ k}\Omega$ to V^+ $V^+ = 36\text{V}$ (32V for LM614C)	$V^- + 0.8$ $V^- + 0.9$	$V^- + 0.95$ $V^- + 1.0$	V max V max
I_{OUT}	Output Source	$V_{\text{OUT}} = 2.5\text{V}$, $V_{+\text{IN}} = 0\text{V}$, $V_{-\text{IN}} = -0.3\text{V}$	25 15	16 13	mA min mA min
I_{SINK}	Output Sink Current	$V_{\text{OUT}} = 1.6\text{V}$, $V_{+\text{IN}} = 0\text{V}$, $V_{-\text{IN}} = 0.3\text{V}$	17 9	13 8	mA min mA min
I_{SHORT}	Short Circuit Current	$V_{\text{OUT}} = 0\text{V}$, $V_{+\text{IN}} = 3\text{V}$, $V_{-\text{IN}} = 2\text{V}$, Source	30 40	50 60	mA max mA max
		$V_{\text{OUT}} = 5\text{V}$, $V_{+\text{IN}} = 2\text{V}$, $V_{-\text{IN}} = 3\text{V}$, Sink	30 32	70 90	mA max mA max
VOLTAGE REFERENCE					
V_{R}	Voltage Reference	(Note 9)	1.244	1.2191 1.2689 ($\pm 2.0\%$)	V min V max
$\frac{\Delta V_{\text{R}}}{\Delta T}$	Average Temperature Drift	(Note 10)	10	150	PPM/ $^\circ\text{C}$ max
$\frac{\Delta V_{\text{R}}}{\Delta T_{\text{J}}}$	Hysteresis	(Note 11)	3.2		$\mu\text{V}/^\circ\text{C}$
$\frac{\Delta V_{\text{R}}}{\Delta I_{\text{R}}}$	V_{R} Change with Current	$V_{\text{R}(100\mu\text{A})} - V_{\text{R}(17\mu\text{A})}$	0.05 0.1	1 1.1	mV max mV max
		$V_{\text{R}(10\text{mA})} - V_{\text{R}(100\mu\text{A})}$ (Note 12)	1.5 2.0	5 5.5	mV max mV max
R	Resistance	$\Delta V_{\text{R}(10 \rightarrow 0.1\text{mA})}/9.9\text{mA}$ $\Delta V_{\text{R}(100 \rightarrow 17\mu\text{A})}/83\mu\text{A}$	0.2 0.6	0.56 13	Ω max Ω max
$\frac{\Delta V_{\text{R}}}{\Delta V_{\text{RO}}}$	V_{R} Change with High V_{RO}	$V_{\text{R}(V_{\text{ro}} = V_{\text{r}})} - V_{\text{R}(V_{\text{ro}} = 5.0\text{V})}$ (3.76V between Anode and FEEDBACK)	2.5 2.8	7 10	mV max mV max
$\frac{\Delta V_{\text{R}}}{\Delta V^+}$	V_{R} Change with V^+ Change	$V_{\text{R}(V^+ = 5\text{V})} - V_{\text{R}(V^+ = 36\text{V})}$ ($V^+ = 32\text{V}$ for LM614C)	0.1 0.1	1.2 1.3	mV max mV max
		$V_{\text{R}(V^+ = 5\text{V})} - V_{\text{R}(V^+ = 3\text{V})}$	0.01 0.01	1 1.5	mV max mV max
I_{FB}	FEEDBACK Bias Current	$V_{\text{ANODE}} \leq V_{\text{FB}} \leq 5.06\text{V}$	22 29	50 55	nA max nA max
e_{n}	Voltage Noise	BW = 10 Hz to 10 kHz,	30		μV_{RMS}

Electrical Characteristics (Continued)

These specifications apply for $V^- = \text{GND} = 0\text{V}$, $V^+ = 5\text{V}$, $V_{\text{CM}} = V_{\text{OUT}} = 2.5\text{V}$, $I_{\text{R}} = 100\mu\text{A}$, FEEDBACK pin shorted to GND, unless otherwise specified. Limits in standard typeface are for $T_{\text{J}} = 25^\circ\text{C}$; limits in **Boldface type** apply over the **Operating Temperature Range**.

Symbol	Parameter	Conditions	Typ (Note 6)	LM614 LM614C Limits (Note 7)	Units
		$V_{\text{RO}} = V_{\text{R}}$			

Note 1: Absolute maximum ratings indicate limits beyond which damage to the component may occur. Electrical specifications do not apply when operating the device beyond its rated operating conditions.

Note 2: Input voltage above V^+ is allowed.

Note 3: More accurately, it is excessive current flow, with resulting excess heating, that limits the voltages on all pins. When any pin is pulled a diode drop below V^- , a parasitic NPN transistor turns ON. No latch-up will occur as long as the current through that pin remains below the Maximum Rating. Operation is undefined and unpredictable when any parasitic diode or transistor is conducting.

Note 4: Junction temperature may be calculated using $T_{\text{J}} = T_{\text{A}} + P_{\text{D}}\theta_{\text{JA}}$. The given thermal resistance is worst-case for packages in sockets in still air. For packages soldered to copper-clad board with dissipation from one comparator or reference output transistor, nominal θ_{JA} is 90°C/W for the WM package.

Note 5: Human body model, 100 pF discharged through a 1.5 kΩ resistor.

Note 6: Typical values in standard typeface are for $T_{\text{J}} = 25^\circ\text{C}$; values in **boldface type** apply for the full operating temperature range. These values represent the most likely parametric norm.

Note 7: All limits are guaranteed at room temperature (standard type face) or at operating temperature extremes (**bold type face**).

Note 8: Slew rate is measured with op amp in a voltage follower configuration. For rising slew rate, the input voltage is driven from 5V to 25V, and the output voltage transition is sampled at 10V and @20V. For falling slew rate, the input voltage is driven from 25V to 5V, and the output voltage transition is sampled at 20V and 10V.

Note 9: V_{R} is the Cathode-feedback voltage, nominally 1.244V.

Note 10: Average reference drift is calculated from the measurement of the reference voltage at 25°C and at the temperature extremes. The drift, in ppm/ $^\circ\text{C}$, is $10^6 \cdot \Delta V_{\text{R}} / (V_{\text{R}[25^\circ\text{C}]} \cdot \Delta T_{\text{J}})$, where ΔV_{R} is the lowest value subtracted from the highest, $V_{\text{R}[25^\circ\text{C}]}$ is the value at 25°C , and ΔT_{J} is the temperature range. This parameter is guaranteed by design and sample testing.

Note 11: Hysteresis is the change in V_{R} caused by a change in T_{J} , after the reference has been "dehysterized". To dehysterize the reference; that is minimize the hysteresis to the typical value, cycle its junction temperature in the following pattern, spiraling in toward 25°C : 25°C , 85°C , -40°C , 70°C , 0°C , 25°C .

Note 12: Low contact resistance is required for accurate measurement.

Typical Performance Characteristics (Reference) $T_{\text{J}} = 25^\circ\text{C}$, FEEDBACK pin shorted to $V^- = 0\text{V}$, unless otherwise noted

Reference Voltage vs. Temperature on 5 Representative Units

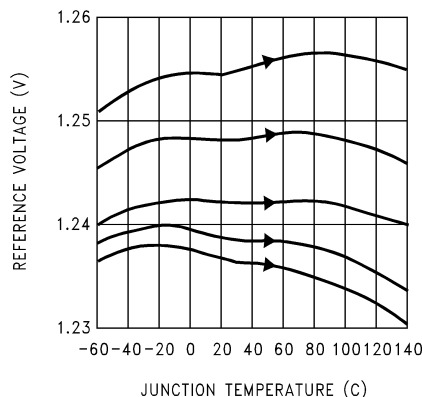

00932647

Reference Voltage Drift

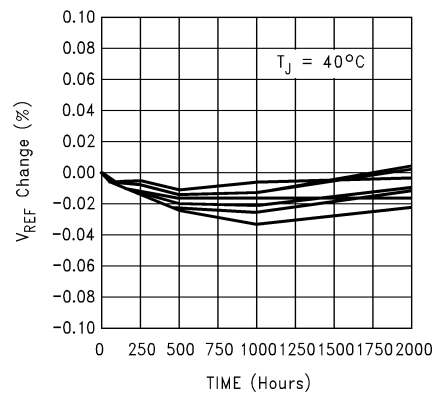

00932648

Typical Performance Characteristics (Reference) $T_J = 25^\circ\text{C}$, FEEDBACK pin shorted to $V^- = 0\text{V}$, unless otherwise noted (Continued)

Accelerated Reference Voltage Drift vs. Time

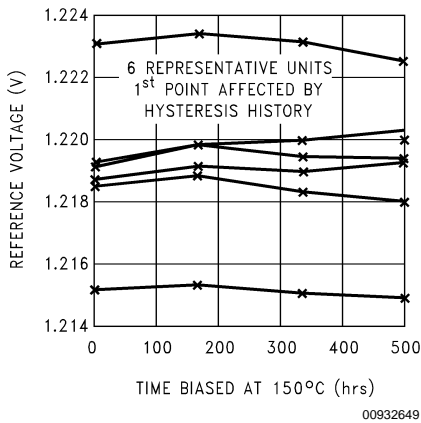

Reference Voltage vs. Current and Temperature

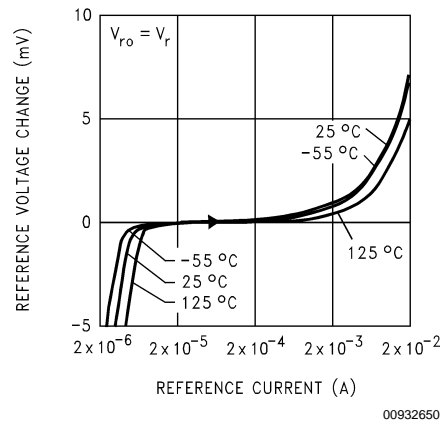

Reference Voltage vs. Current and Temperature

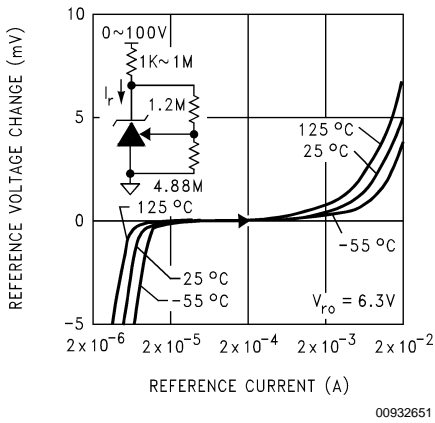

Reference Voltage vs. Reference Current

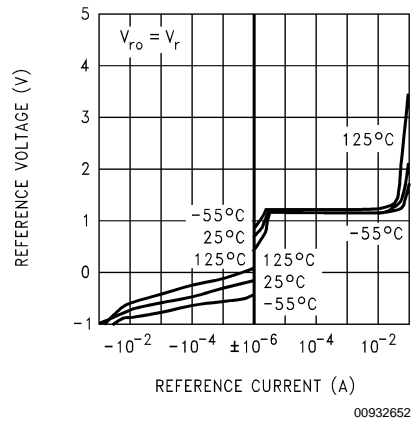

Reference Voltage vs. Reference Current

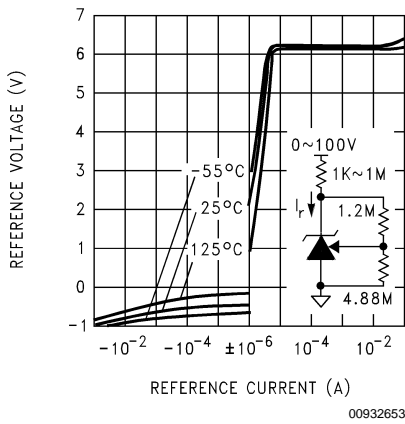

Reference AC Stability Range

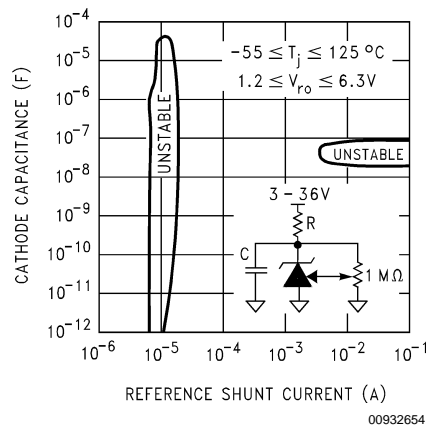

Typical Performance Characteristics (Reference) $T_J = 25^\circ\text{C}$, FEEDBACK pin shorted to $V^- = 0\text{V}$, unless otherwise noted (Continued)

FEEDBACK Current vs. FEEDBACK-to-Anode Voltage

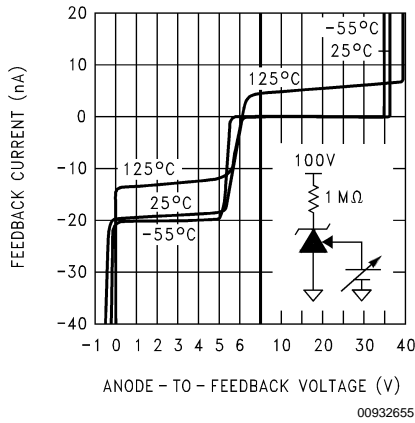

FEEDBACK Current vs. FEEDBACK-to-Anode Voltage

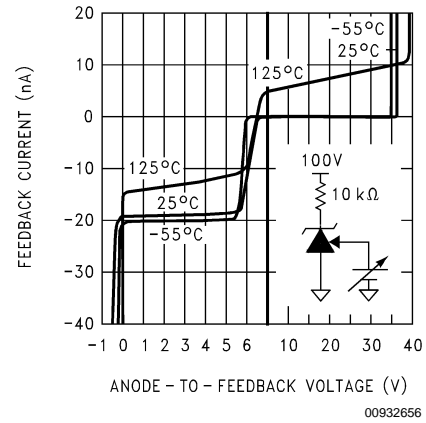

Reference Noise Voltage vs. Frequency

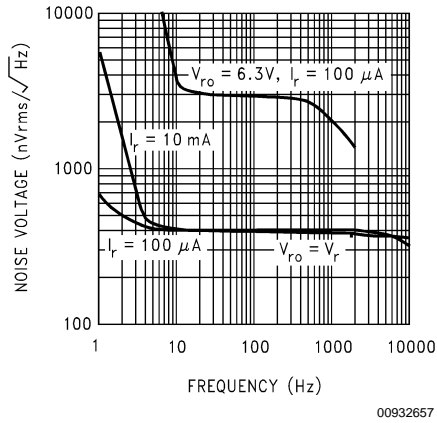

Reference Small-Signal Resistance vs. Frequency

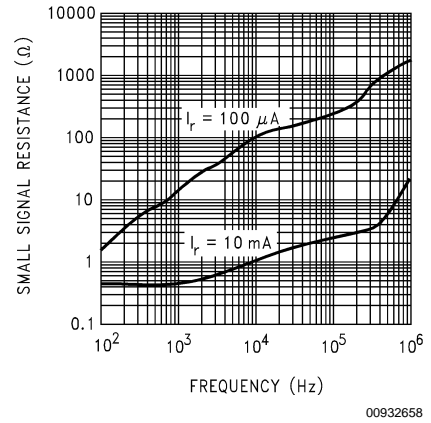

Reference Power-Up Time

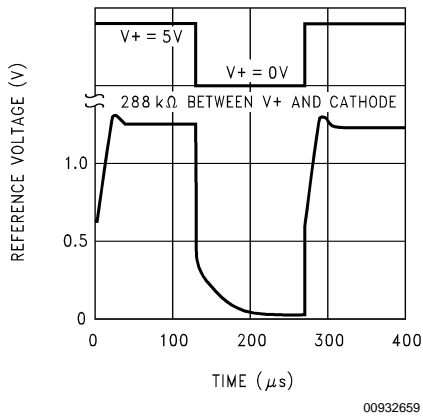

Reference Voltage with FEEDBACK Voltage Step

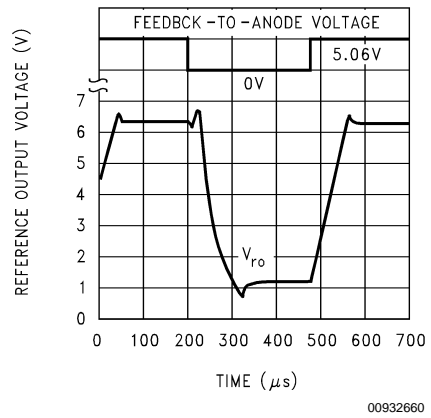

Typical Performance Characteristics (Reference) $T_J = 25^\circ\text{C}$, FEEDBACK pin shorted to $V^- = 0\text{V}$, unless otherwise noted (Continued)

Reference Voltage with 100–12 μA Current Step

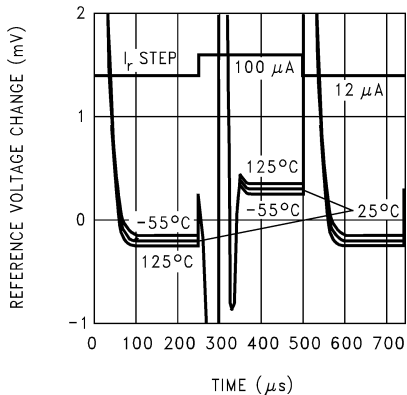

00932661

Reference Step Response for 100 μA ~ 10 mA Current Step

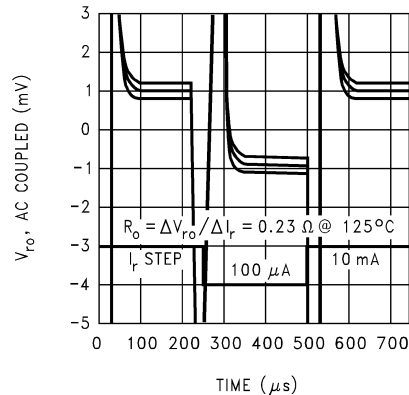

00932662

Reference Voltage Change with Supply Voltage Step

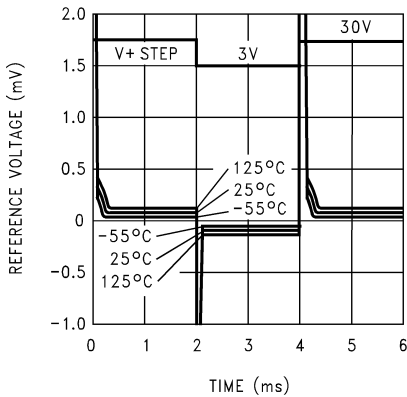

00932663

Typical Performance Characteristics (Op Amps) $V^+ = 5\text{V}$, $V^- = \text{GND} = 0\text{V}$, $V_{CM} = V^+/2$, $V_{OUT} = V^+/2$, $T_J = 25^\circ\text{C}$, unless otherwise noted

Input Common-Mode Voltage Range vs. Temperature

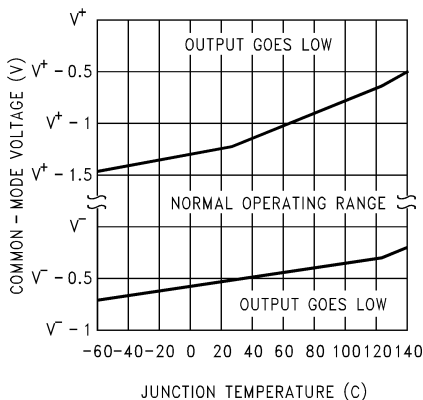

00932664

V_{OS} vs. Junction Temperature on 9 Representative Units

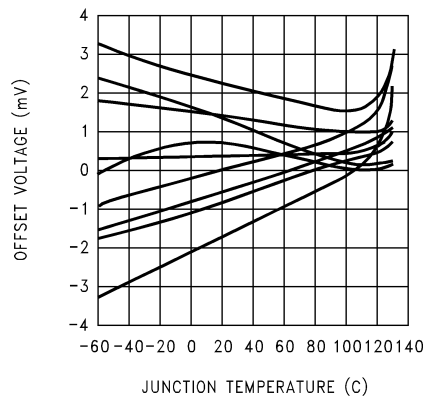

00932665

Typical Performance Characteristics (Op Amps) $V^+ = 5V, V^- = GND = 0V, V_{CM} = V^+/2,$
 $V_{OUT} = V^+/2, T_J = 25^\circ C,$ unless otherwise noted (Continued)

Input Bias Current vs. Common-Mode Voltage

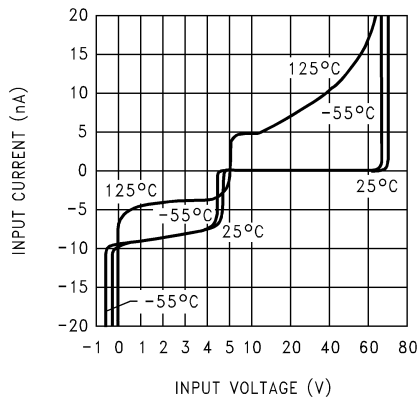

00932666

Slew Rate vs. Temperature and Output Sink Current

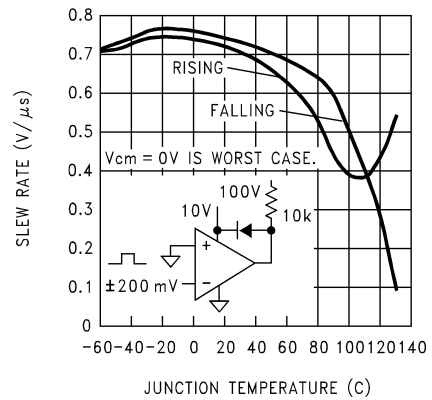

00932667

Large-Signal Step Response

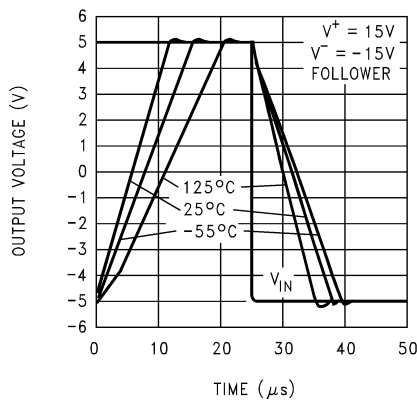

00932668

Output Voltage Swing vs. Temp. and Current

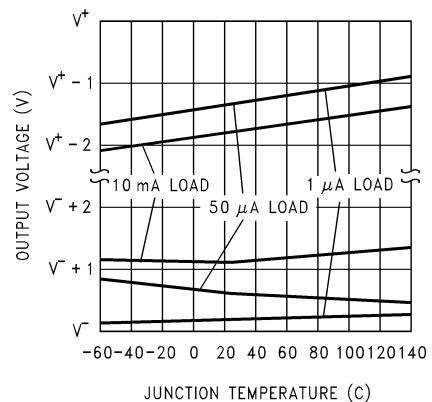

00932669

Output Source Current vs. Output Voltage and Temp.

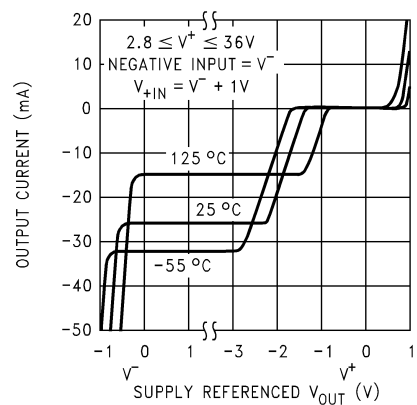

00932670

Output Sink Current vs. Output Voltage and Temp.

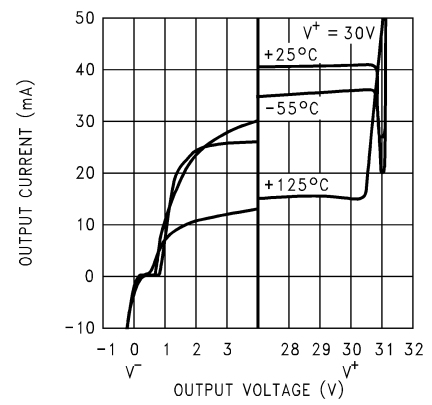

00932671

Typical Performance Characteristics (Op Amps) $V^+ = 5V, V^- = GND = 0V, V_{CM} = V^+/2,$

$V_{OUT} = V^+/2, T_J = 25^\circ C,$ unless otherwise noted (Continued)

Output Swing, Large Signal

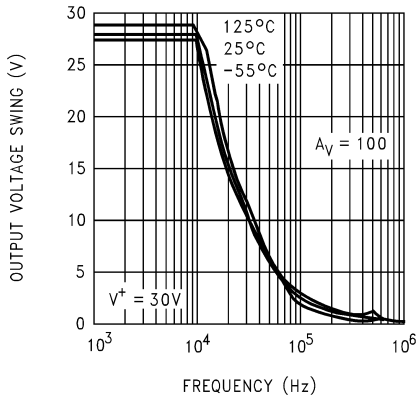

00932672

Output Impedance vs. Frequency and Gain

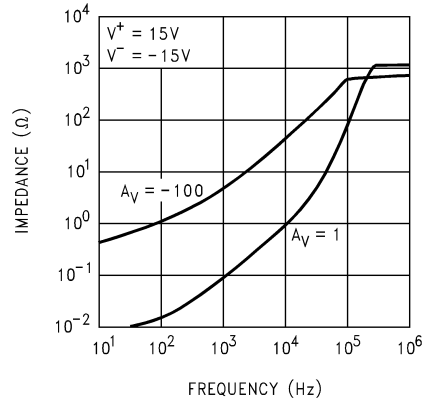

00932673

Small-Signal Pulse Response vs. Temp.

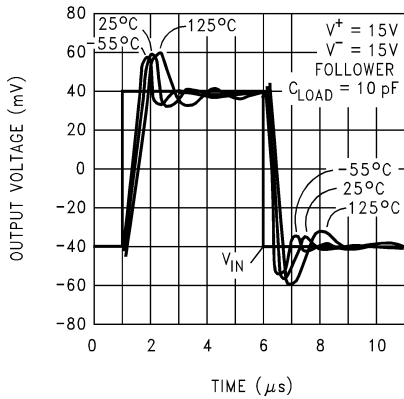

00932674

Small-Signal Pulse Response vs. Load

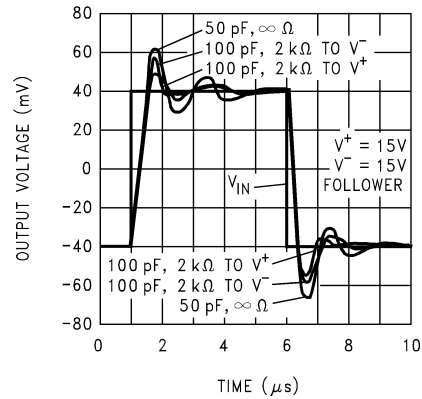

00932675

Op Amp Voltage Noise vs. Frequency

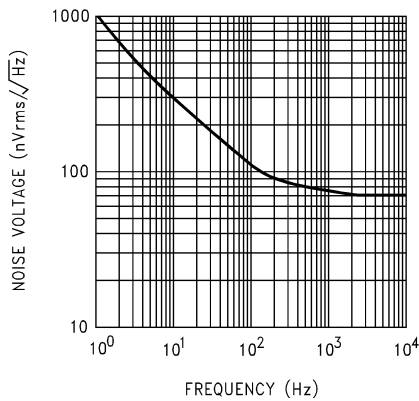

00932676

Op Amp Current Noise vs. Frequency

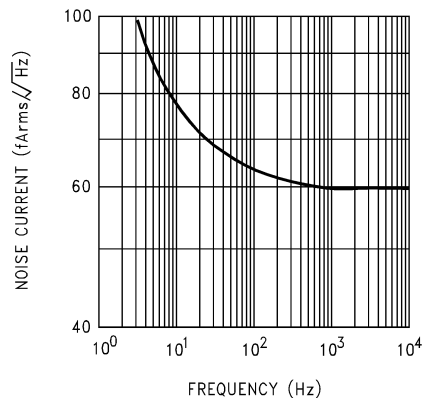

00932677

Typical Performance Characteristics (Op Amps)

$V_{OUT} = V^+/2$, $T_J = 25^\circ\text{C}$, unless otherwise noted (Continued)

$V^+ = 5\text{V}$, $V^- = \text{GND} = 0\text{V}$, $V_{CM} = V^+/2$,

Small-Signal Voltage Gain vs. Frequency and Temperature

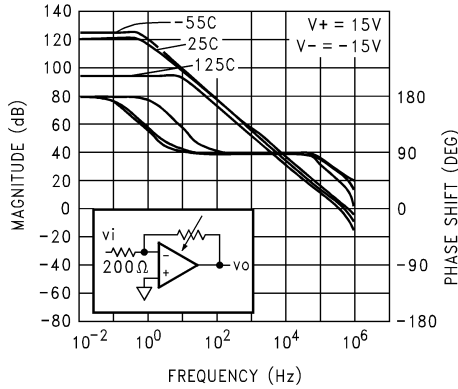

Small-Signal Voltage Gain vs. Frequency and Load

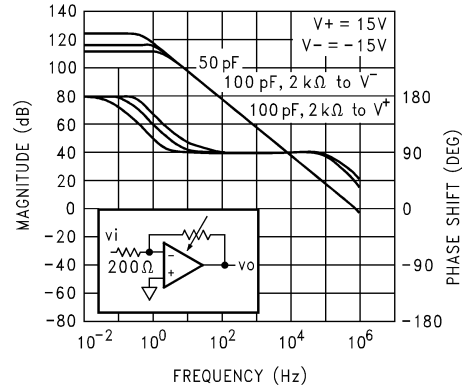

Follower Small-Signal Frequency Response

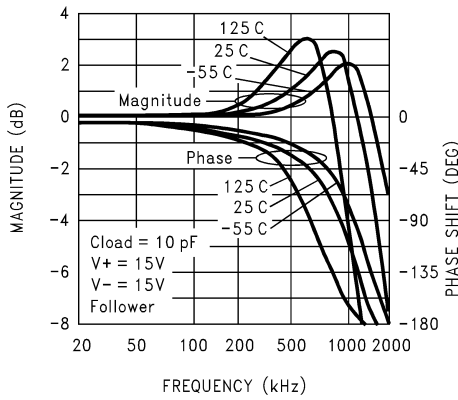

Common-Mode Input Voltage Rejection Ratio

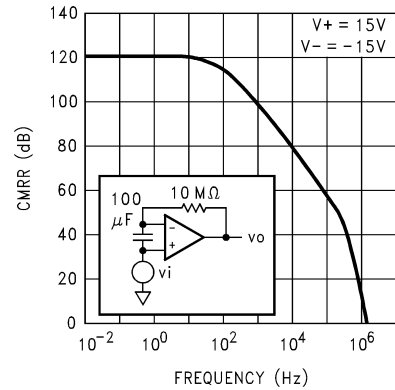

Power Supply Current vs. Power Supply Voltage

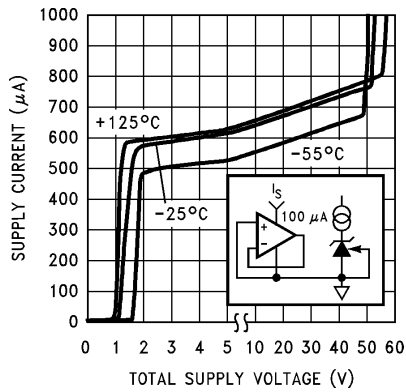

Positive Power Supply Voltage Rejection Ratio

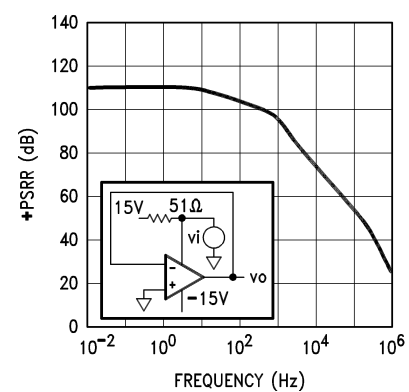

Typical Performance Characteristics (Op Amps) $V^+ = 5V, V^- = GND = 0V, V_{CM} = V^+/2,$

$V_{OUT} = V^+/2, T_J = 25^\circ C,$ unless otherwise noted (Continued)

Negative Power Supply Voltage Rejection Ratio

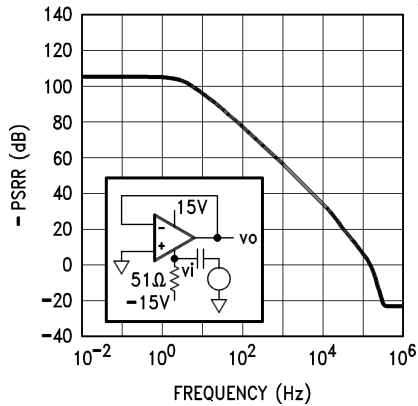

00932622

Input Offset Current vs. Junction Temperature

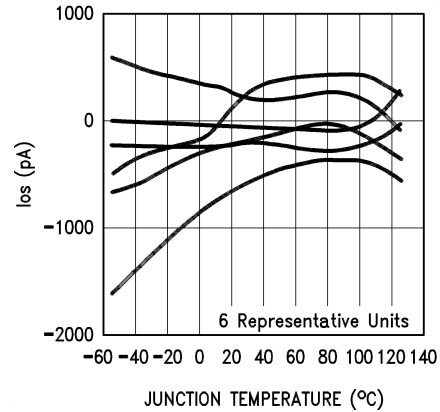

00932624

Input Bias Current vs. Junction Temperature

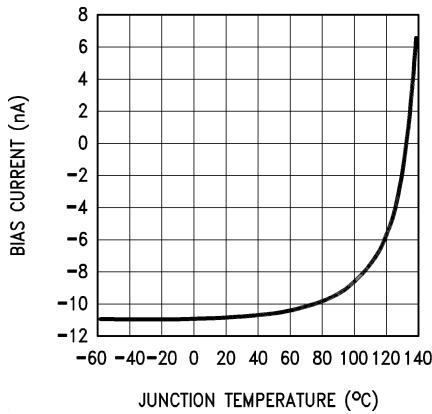

00932638

Typical Performance Distributions

Average V_{OS} Drift Industrial Temperature Range

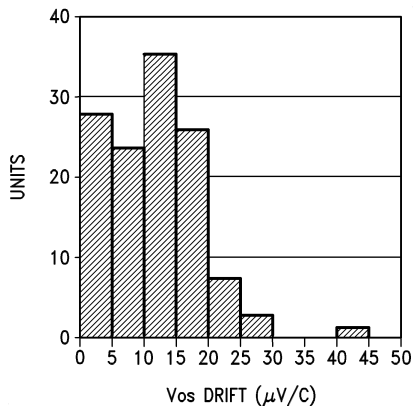

00932630

Average V_{OS} Drift Commercial Temperature Range

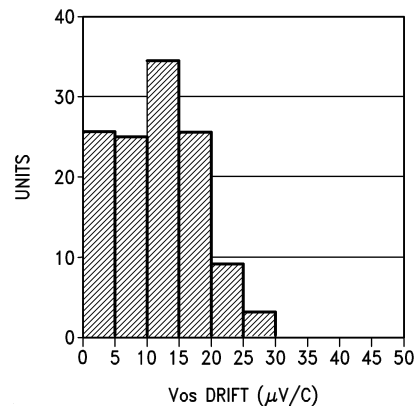

00932631

Typical Performance Distributions (Continued)

Average I_{OS} Drift Industrial Temperature Range

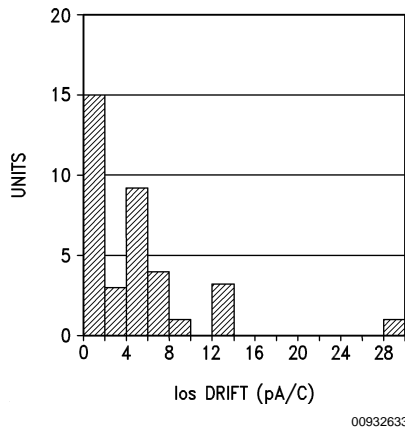

Average I_{OS} Drift Commercial Temperature Range

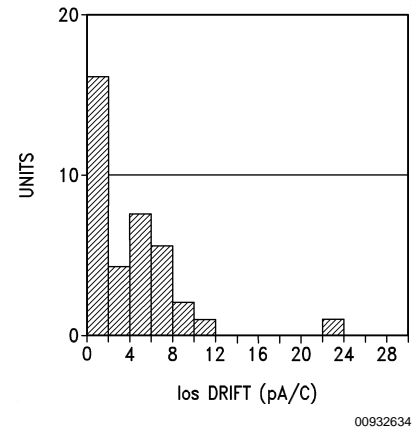

Voltage Reference Broad-Band Noise Distribution

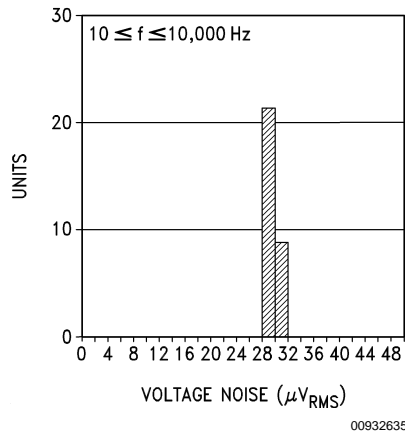

Op Amp Voltage Noise Distribution

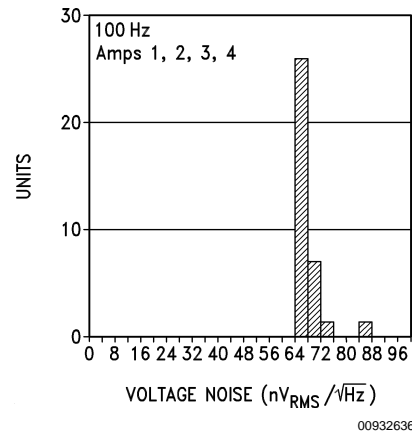

Op Amp Current Noise Distribution

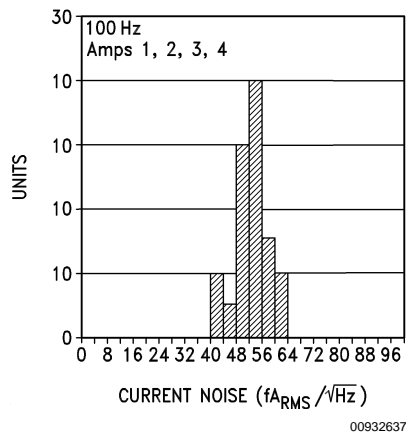

Application Information

VOLTAGE REFERENCE

Reference Biasing

The voltage reference is of a shunt regulator topology that models as a simple zener diode. With current I_r flowing in the “forward” direction there is the familiar diode transfer function. I_r flowing in the reverse direction forces the reference voltage to be developed from cathode to anode. The cathode may swing from a diode drop below V^- to the reference voltage or to the avalanche voltage of the parallel protection diode, nominally 7V. A 5.0V reference with $V^+ = 3V$ is allowed.

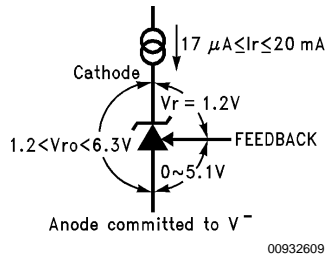

FIGURE 1. Voltages Associated with Reference (Current Source I_r is External)

The reference equivalent circuit reveals how V_r is held at the constant 1.2V by feedback, and how the FEEDBACK pin passes little current.

To generate the required reverse current, typically a resistor is connected from a supply voltage higher than the reference voltage. Varying that voltage, and so varying I_r , has small effect with the equivalent series resistance of less than an ohm at the higher currents. Alternatively, an active current source, such as the LM134 series, may generate I_r .

Adjustable Reference

The FEEDBACK pin allows the reference output voltage, V_{ro} , to vary from 1.24V to 5.0V. The reference attempts to hold V_r at 1.24V. If V_r is above 1.24V, the reference will conduct current from Cathode to Anode; FEEDBACK current always remains low. If FEEDBACK is connected to Anode, then $V_{ro} = V_r = 1.24V$. For higher voltages FEEDBACK is held at a constant voltage above Anode—say 3.76V for $V_{ro} = 5V$. Connecting a resistor across the constant V_r generates a current $I = V_r/R1$ flowing from Cathode into FEEDBACK node. A Thevenin equivalent 3.76V is generated from FEEDBACK to Anode with $R2 = 3.76/I$. For a 1% error, use $R1$ such that I is greater than one hundred times the FEEDBACK bias current. For example, keep $I \geq 5.5 \mu A$.

Capacitors in parallel with the reference are allowed. See the Reference AC Stability Range typical curve for capacitance values—from 20 μA to 3 mA any capacitor value is stable. With the reference's wide stability range with resistive and capacitive loads, a wide range of RC filter values will perform noise filtering.

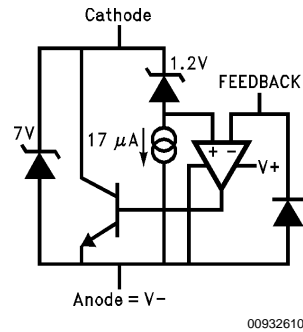

FIGURE 2. Reference Equivalent Circuit

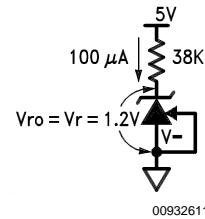

FIGURE 3. 1.2V Reference

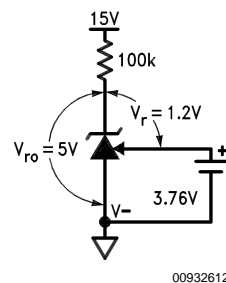
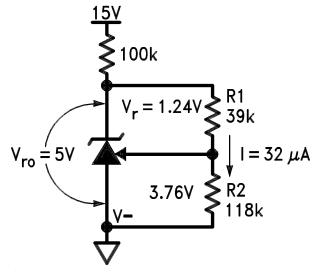

FIGURE 4. Thevenin Equivalent of Reference with 5V Output

Application Information (Continued)



00932613

$R1 = Vr/I = 1.24/32\mu = 39k$
 $R2 = R1 \{(Vro/Vr) - 1\} = 39k \{(5/1.24) - 1\} = 118k$

FIGURE 5. Resistors R1 and R2 Program Reference Output Voltage to be 5V

Understanding that V_r is fixed and that voltage sources, resistors, and capacitors may be tied to the FEEDBACK pin, a range of V_r temperature coefficients may be synthesized.

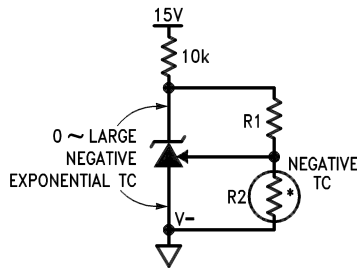

00932614

FIGURE 6. Output Voltage has Negative Temperature Coefficient (TC) if R2 has Negative TC

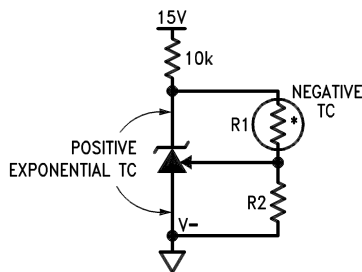

00932615

FIGURE 7. Output Voltage has Positive TC if R1 has Negative TC

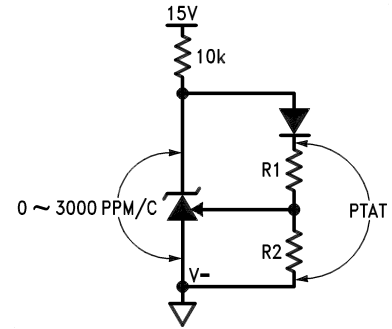

00932616

FIGURE 8. Diode in Series with R1 Causes Voltage across R1 and R2 to be Proportional to Absolute Temperature (PTAT)

Connecting a resistor across Cathode-to-FEEDBACK creates a 0 TC current source, but a range of TCs may be synthesized.

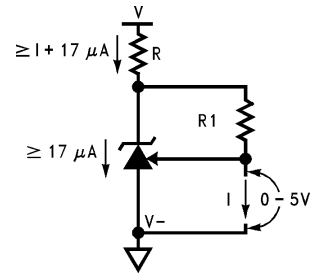

00932617

$I = Vr/R1 = 1.24/R1$

FIGURE 9. Current Source is Programmed by R1

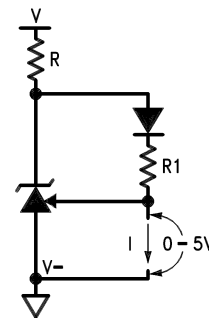

00932618

FIGURE 10. Proportional-to-Absolute-Temperature Current Source

Application Information (Continued)

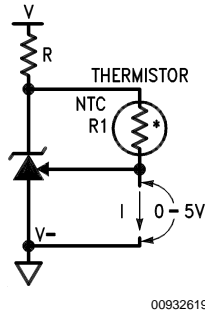

FIGURE 11. Negative-TC Current Source

Hysteresis

The reference voltage depends, slightly, on the thermal history of the die. Competitive micro-power products vary—always check the data sheet for any given device. Do not assume that no specification means no hysteresis.

OPERATIONAL AMPLIFIERS

Any amp or the reference may be biased in any way with no effect on the other amps or reference, except when a substrate diode conducts (see Guaranteed Electrical Characteristics (Note 1)). One amp input may be outside the common-mode range, another amp may be operated as a comparator, another with all terminals floating with no effect on the others (tying inverting input to output and

non-inverting input to V^- on unused amps is preferred). Choosing operating points that cause oscillation, such as driving too large a capacitive load, is best avoided.

Op Amp Output Stage

These op amps, like their LM124 series, have flexible and relatively wide-swing output stages. There are simple rules to optimize output swing, reduce cross-over distortion, and optimize capacitive drive capability:

1. **Output Swing:** Unloaded, the $42\mu\text{A}$ pull-down will bring the output within 300 mV of V^- over the military temperature range. If more than $42\mu\text{A}$ is required, a resistor from output to V^- will help. Swing across any load may be improved slightly if the load can be tied to V^+ , at the cost of poorer sinking open-loop voltage gain
2. **Cross-over Distortion:** The LM614 has lower cross-over distortion (a $1 V_{BE}$ deadband versus $3 V_{BE}$ for the LM124), and increased slew rate as shown in the characteristic curves. A resistor pull-up or pull-down will force class-A operation with only the PNP or NPN output transistor conducting, eliminating cross-over distortion
3. **Capacitive Drive:** Limited by the output pole caused by the output resistance driving capacitive loads, a pull-down resistor conducting 1 mA or more reduces the output stage NPN r_o until the output resistance is that of the current limit 25Ω . 200pF may then be driven without oscillation.

Op Amp Input Stage

The lateral PNP input transistors, unlike most op amps, have BV_{EBO} equal to the absolute maximum supply voltage. Also, they have no diode clamps to the positive supply nor across the inputs. These features make the inputs look like high impedances to input sources producing large differential and common-mode voltages.

Typical Applications

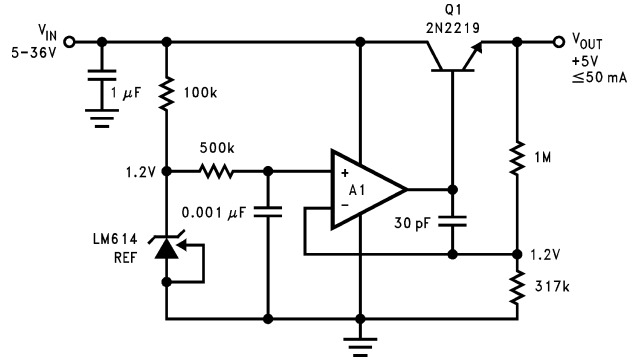

00932642

FIGURE 12. Simple Low Quiescent Drain Voltage Regulator. Total supply current approximately 320μA, when $V_{IN} = +5V$.

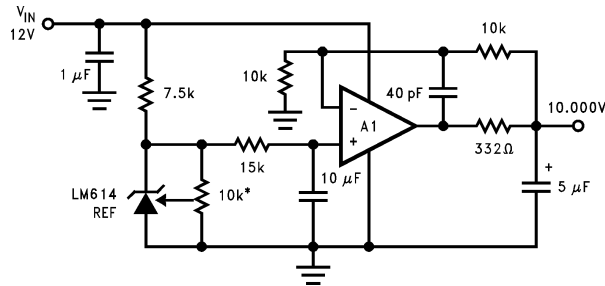

00932643

*10k must be low
t.c. trimpot.

FIGURE 13. Ultra Low Noise 10.00V Reference. Total output noise is typically 14μV_{RMS}.

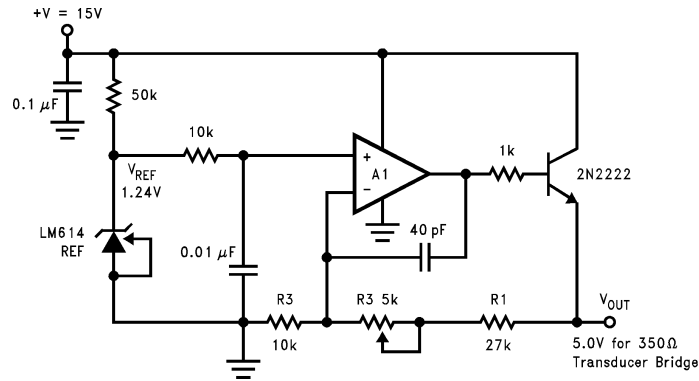

00932644

$V_{OUT} = (R_1 / P_e + 1) V_{REF}$
 R_1, R_2 should be 1% metal film
 P_β should be low T.C. trim pot

FIGURE 14. Slow Rise Time Upon Power-Up, Adjustable Transducer Bridge Driver. Rise time is approximately 1ms.

Typical Applications (Continued)

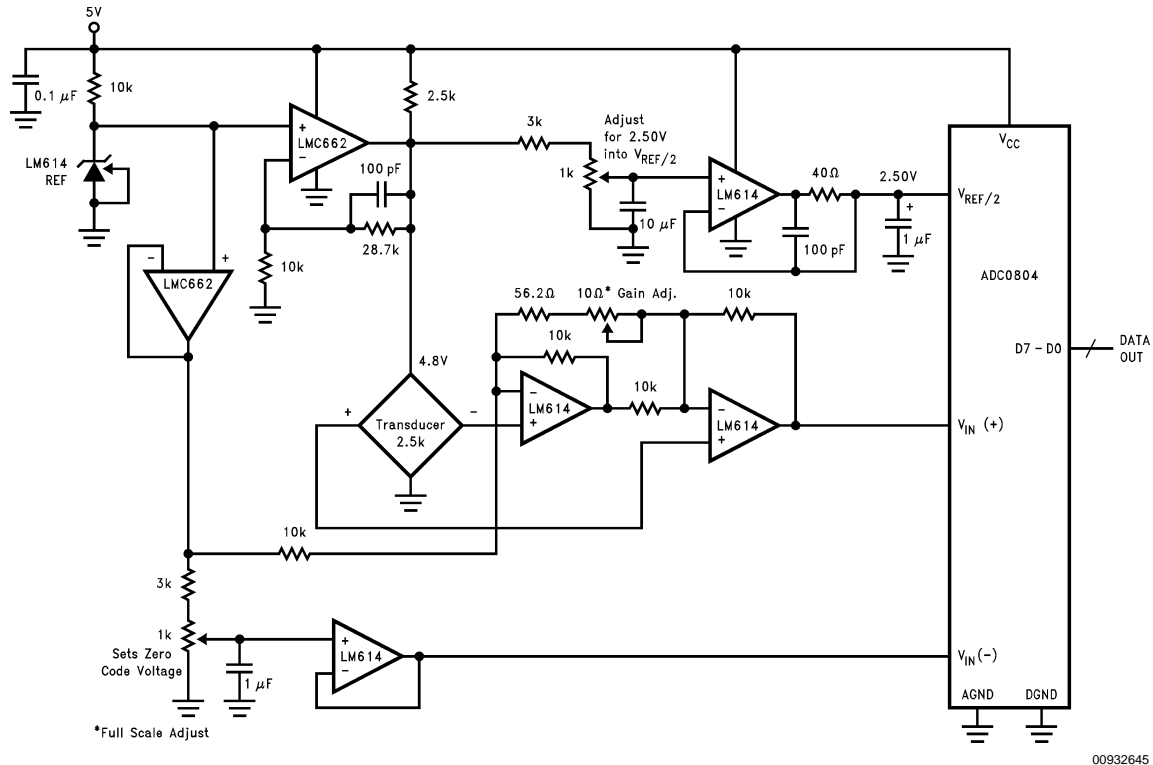
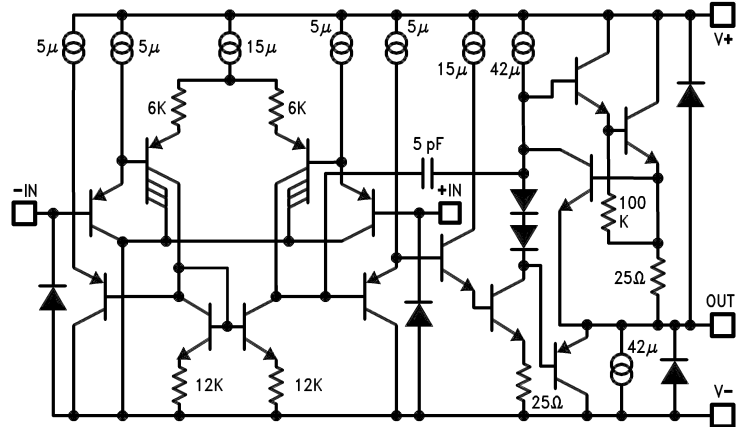

FIGURE 15. Transducer Data Acquisition System. Set zero code voltage, then adjust 10 Ω gain adjust pot for full scale.

Simplified Schematic Diagrams

Op Amp



00932602

Reference / Bias

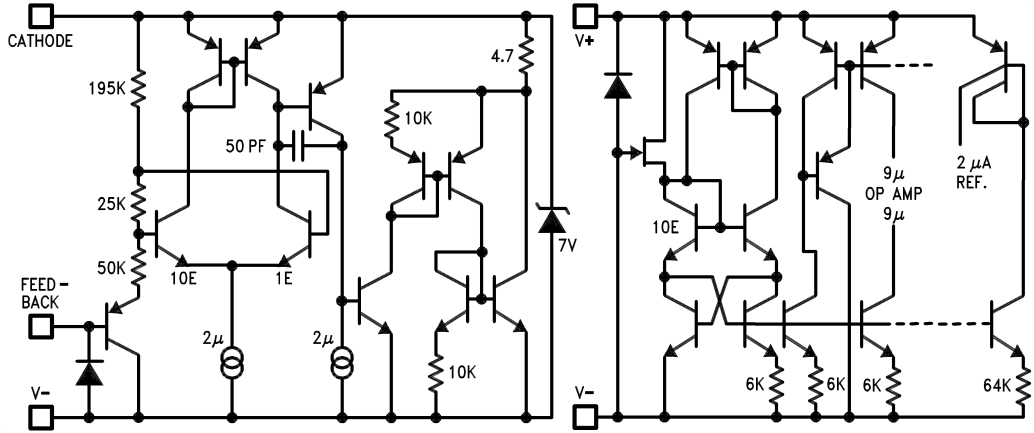

00932603

Physical Dimensions inches (millimeters)

unless otherwise noted

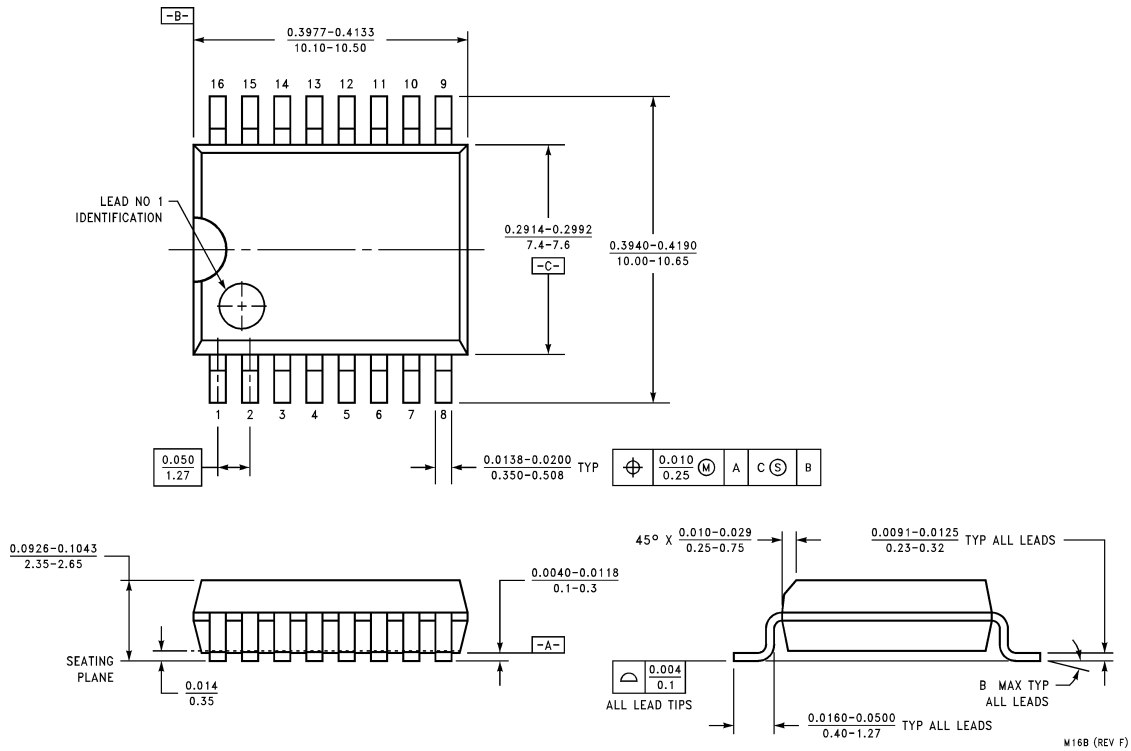

**16-Lead Molded Small Outline Package (WM)
NS Package Number M16B**

LIFE SUPPORT POLICY

NATIONAL'S PRODUCTS ARE NOT AUTHORIZED FOR USE AS CRITICAL COMPONENTS IN LIFE SUPPORT DEVICES OR SYSTEMS WITHOUT THE EXPRESS WRITTEN APPROVAL OF THE PRESIDENT AND GENERAL COUNSEL OF NATIONAL SEMICONDUCTOR CORPORATION. As used herein:

1. Life support devices or systems are devices or systems which, (a) are intended for surgical implant into the body, or (b) support or sustain life, and whose failure to perform when properly used in accordance with instructions for use provided in the labeling, can be reasonably expected to result in a significant injury to the user.
2. A critical component is any component of a life support device or system whose failure to perform can be reasonably expected to cause the failure of the life support device or system, or to affect its safety or effectiveness.



National Semiconductor Corporation
Americas
Email: support@nsc.com

National Semiconductor Europe
Fax: +49 (0) 180-530 85 86
Email: europe.support@nsc.com
Deutsch Tel: +49 (0) 69 9508 6208
English Tel: +44 (0) 870 24 0 2171
Français Tel: +33 (0) 1 41 91 8790

National Semiconductor Asia Pacific Customer Response Group
Tel: 65-2544466
Fax: 65-2504466
Email: ap.support@nsc.com

National Semiconductor Japan Ltd.
Tel: 81-3-5639-7560
Fax: 81-3-5639-7507

www.national.com