

# AT-42035

## Up to 6 GHz Medium Power Silicon Bipolar Transistor



## Data Sheet

### Description

Avago's AT-42035 is a general purpose NPN bipolar transistor that offers excellent high frequency performance. The AT-42035 is housed in a cost effective surface mount 100 mil micro-X package. The 4 micron emitter-to-emitter pitch enables this transistor to be used in many different functions. The 20 emitter finger interdigitated geometry yields a medium sized transistor with impedances that are easy to match for low noise and medium power applications. This device is designed for use in low noise, wideband amplifier, mixer and oscillator applications in the VHF, UHF, and microwave frequencies. An optimum noise match near  $50 \Omega$  up to 1 GHz, makes this device easy to use as a low noise amplifier.

The AT-42035 bipolar transistor is fabricated using Avago's 10 GHz  $f_T$  Self-Aligned-Transistor (SAT) process. The die is nitride passivated for surface protection. Excellent device uniformity, performance and reliability are produced by the use of ion-implantation, self-alignment techniques, and gold metalization in the fabrication of this device.

### Features

- **High Output Power:**  
21.0 dBm Typical  $P_{1\text{ dB}}$  at 2.0 GHz  
20.5 dBm Typical  $P_{1\text{ dB}}$  at 4.0 GHz
- **High Gain at 1 dB Compression:**  
14.0 dB Typical  $G_{1\text{ dB}}$  at 2.0 GHz  
9.5 dB Typical  $G_{1\text{ dB}}$  at 4.0 GHz
- **Low Noise Figure:**  
1.9 dB Typical  $NF_O$  at 2.0 GHz
- **High Gain-Bandwidth Product:** 8.0 GHz Typical  $f_T$
- **Cost Effective Ceramic Microstrip Package**

### 35 micro-X Package

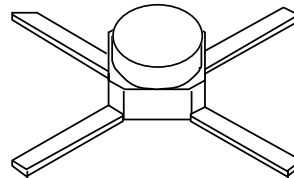

## AT-42035 Absolute Maximum Ratings<sup>[1]</sup>

Symbol	Parameter	Units	Absolute Maximum
V <sub>EBO</sub>	Emitter-Base Voltage	V	1.5
V <sub>CBO</sub>	Collector-Base Voltage	V	20
V <sub>CEO</sub>	Collector-Emitter Voltage	V	12
I <sub>C</sub>	Collector Current	mA	80
P <sub>T</sub>	Power Dissipation <sup>[2,3]</sup>	mW	600
T <sub>j</sub>	Junction Temperature	°C	150
T <sub>STG</sub>	Storage Temperature <sup>[4]</sup>	°C	-65 to 150

Thermal Resistance<sup>[2,5]</sup>:

$$\theta_{jc} = 175^{\circ}\text{C/W}$$

### Notes:

- Permanent damage may occur if any of these limits are exceeded.
- T<sub>CASE</sub> = 25°C.
- Derate at 5.7 mW/°C for T<sub>C</sub> > 95°C.
- Storage above +150°C may tarnish the leads of this package making it difficult to solder into a circuit.
- The small spot size of this technique results in a higher, though more accurate determination of  $\theta_{jc}$  than do alternate methods. See MEASUREMENTS section "Thermal Resistance" for more information.

## Electrical Specifications, T<sub>A</sub> = 25°C

Symbol	Parameters and Test Conditions <sup>[1]</sup>	Units	Min.	Typ.	Max.
S <sub>21E</sub>   <sup>2</sup>	Insertion Power Gain; V <sub>CE</sub> = 8 V, I <sub>C</sub> = 35 mA	f = 2.0 GHz f = 4.0 GHz	dB	10.0	11.0 5.0
P <sub>1 dB</sub>	Power Output @ 1 dB Gain Compression V <sub>CE</sub> = 8 V, I <sub>C</sub> = 35 mA	f = 2.0 GHz f = 4.0 GHz	dBm		21.0 20.5
G <sub>1 dB</sub>	1 dB Compressed Gain; V <sub>CE</sub> = 8 V, I <sub>C</sub> = 35 mA	f = 2.0 GHz f = 4.0 GHz	dB		14.0 9.5
NF <sub>O</sub>	Optimum Noise Figure; V <sub>CE</sub> = 8 V, I <sub>C</sub> = 10 mA	f = 2.0 GHz f = 4.0 GHz	dB		2.0 3.0
G <sub>A</sub>	Gain @ NF <sub>O</sub> ; V <sub>CE</sub> = 8 V, I <sub>C</sub> = 10 mA	f = 2.0 GHz f = 4.0 GHz	dB		13.5 10.0
f <sub>T</sub>	Gain Bandwidth Product; V <sub>CE</sub> = 8 V, I <sub>C</sub> = 35 mA		GHz		8.0
h <sub>FE</sub>	Forward Current Transfer Ratio; V <sub>CE</sub> = 8 V, I <sub>C</sub> = 35 mA		—	30	150 270
I <sub>CBO</sub>	Collector Cutoff Current; V <sub>CB</sub> = 8 V		μA		0.2
I <sub>EBO</sub>	Emitter Cutoff Current; V <sub>EB</sub> = 1 V		μA		2.0
C <sub>CB</sub>	Collector Base Capacitance <sup>[1]</sup> ; V <sub>CB</sub> = 8 V, f = 1 MHz		pF		0.28

### Notes:

- For this test, the emitter is grounded.

**AT-42035 Typical Performance,  $T_A = 25^\circ\text{C}$**

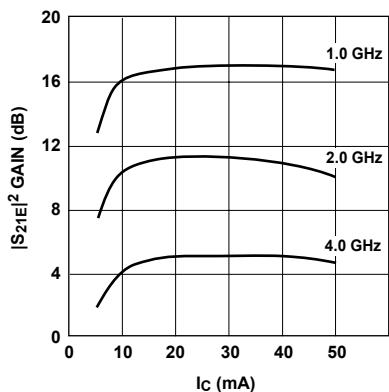

**Figure 1. Insertion Power Gain vs. Collector Current and Frequency.  $V_{CE} = 8\text{ V}$ .**

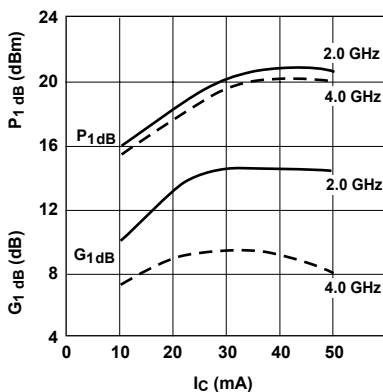

**Figure 2. Output Power and 1 dB Compressed Gain vs. Collector Current and Frequency.  $V_{CE} = 8\text{ V}$ .**

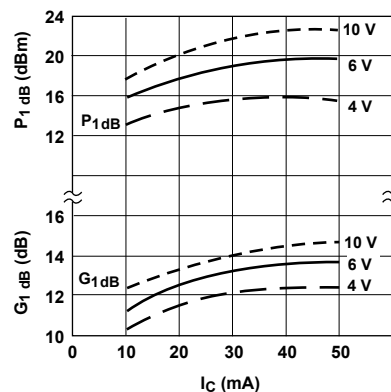

**Figure 3. Output Power and 1 dB Compressed Gain vs. Collector Current and Voltage.  $f = 2.0\text{ GHz}$ .**

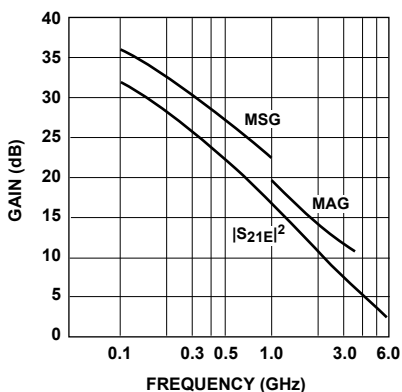

**Figure 4. Insertion Power Gain, Maximum Available Gain and Maximum Stable Gain vs. Frequency.  $V_{CE} = 8\text{ V}$ ,  $I_C = 35\text{ mA}$ .**

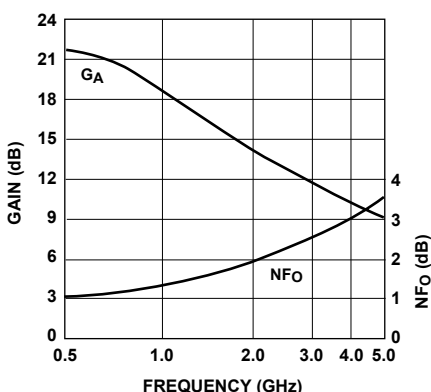

**Figure 5. Noise Figure and Associated Gain vs. Frequency.  $V_{CE} = 8\text{ V}$ ,  $I_C = 10\text{ mA}$ .**

### AT-42035 Typical Scattering Parameters,

Common Emitter,  $Z_O = 50 \Omega$ ,  $T_A = 25^\circ\text{C}$ ,  $V_{CE} = 8 \text{ V}$ ,  $I_C = 10 \text{ mA}$

Freq. GHz	$S_{11}$			$S_{21}$			$S_{12}$		$S_{22}$	
	Mag.	Ang.	dB	Mag.	Ang.	dB	Mag.	Ang.	Mag.	Ang.
0.1	.72	-46	28.3	26.09	152	-37.0	.014	73	.92	-14
0.5	.59	-137	20.9	11.13	102	-31.0	.028	44	.58	-27
1.0	.56	-171	15.4	5.91	80	-28.2	.039	47	.51	-29
1.5	.56	169	12.1	4.03	67	-26.6	.047	52	.50	-33
2.0	.58	155	9.7	3.06	55	-24.2	.062	55	.48	-38
2.5	.59	147	8.0	2.50	48	-22.6	.074	61	.47	-42
3.0	.61	137	6.5	2.10	38	-20.8	.092	65	.46	-51
3.5	.63	128	5.2	1.82	27	-19.6	.105	62	.47	-63
4.0	.63	117	4.0	1.60	17	-18.0	.126	57	.49	-72
4.5	.63	106	3.1	1.43	7	-16.5	.149	53	.51	-80
5.0	.64	93	2.3	1.30	-3	-15.4	.169	48	.52	-87
5.5	.67	79	1.5	1.19	-13	-14.3	.193	41	.51	-94
6.0	.72	70	0.6	1.07	-23	-13.4	.215	35	.46	-105

### AT-42035 Typical Scattering Parameters,

Common Emitter,  $Z_O = 50 \Omega$ ,  $T_A = 25^\circ\text{C}$ ,  $V_{CE} = 8 \text{ V}$ ,  $I_C = 35 \text{ mA}$

Freq. GHz	$S_{11}$			$S_{21}$			$S_{12}$		$S_{22}$	
	Mag.	Ang.	dB	Mag.	Ang.	dB	Mag.	Ang.	Mag.	Ang.
0.1	.50	-88	33.2	45.64	135	-42.0	.008	68	.77	-22
0.5	.52	-164	22.4	13.24	92	-32.8	.023	57	.45	-25
1.0	.53	174	16.6	6.75	76	-28.2	.039	63	.42	-26
1.5	.53	160	13.1	4.55	64	-25.6	.053	66	.41	-30
2.0	.55	148	10.8	3.45	53	-23.2	.069	65	.41	-36
2.5	.57	142	9.0	2.81	47	-21.6	.084	67	.39	-40
3.0	.59	134	7.5	2.37	37	-20.0	.101	64	.38	-49
3.5	.60	125	6.3	2.06	27	-18.4	.120	61	.39	-61
4.0	.60	116	5.2	1.81	17	-17.0	.141	57	.41	-71
4.5	.60	104	4.2	1.62	7	-16.0	.158	50	.43	-78
5.0	.61	92	3.4	1.47	-2	-14.9	.179	45	.44	-84
5.5	.64	79	2.6	1.35	-13	-14.1	.198	37	.43	-91
6.0	.69	70	1.7	1.21	-23	-13.2	.219	30	.38	-102

A model for this device is available in the DEVICE MODELS section.

### AT-42035 Noise Parameters: $V_{CE} = 8 \text{ V}$ , $I_C = 10 \text{ mA}$

Freq. GHz	$NF_0$	$\Gamma_{opt}$		$R_N/50$
	dB	Mag	Ang	
0.1	1.0	.04	10	0.13
0.5	1.1	.04	66	0.12
1.0	1.3	.07	150	0.12
2.0	2.0	.20	-178	0.12
4.0	3.0	.51	-110	0.36

## Ordering Information

Part Numbers	No. of Devices
AT-42035G	10

## 35 micro-X Package Dimensions

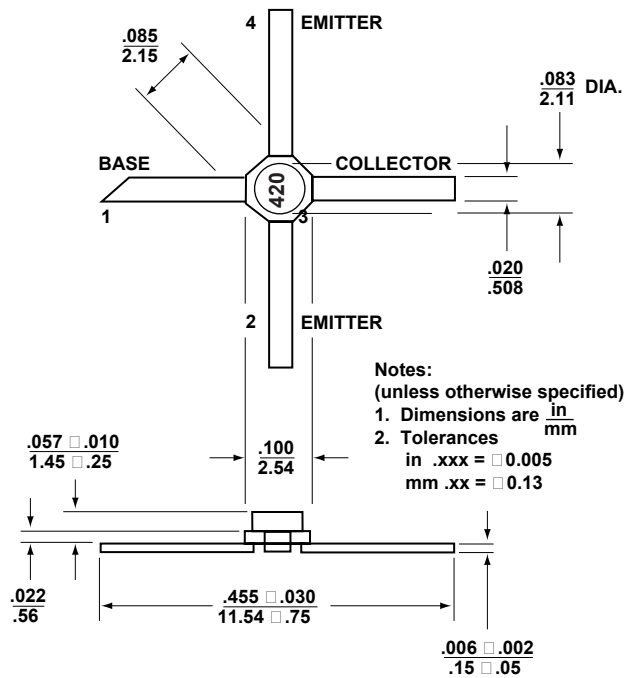

For product information and a complete list of distributors, please go to our web site: [www.avagotech.com](http://www.avagotech.com)

Avago, Avago Technologies, and the A logo are trademarks of Avago Technologies, Limited in the United States and other countries. Data subject to change. Copyright © 2006 Avago Technologies, Limited. All rights reserved. Obsoletes 5989-2652EN AV02-0299EN - April 10, 2007

**AVAGO**  
TECHNOLOGIES