



Up to 6 GHz Medium Power Silicon Bipolar Transistor Chip

Technical Data

AT-42000

Features

- **High Output Power:**
21.0 dBm Typical $P_{1\text{ dB}}$ at 2.0 GHz
20.5 dBm Typical $P_{1\text{ dB}}$ at 4.0 GHz
- **High Gain at 1 dB
Compression:**
15.0 dB Typical $G_{1\text{ dB}}$ at 2.0 GHz
10.0 dB Typical $G_{1\text{ dB}}$ at 4.0 GHz
- **Low Noise Figure:** 1.9 dB
Typical NF_0 at 2.0 GHz
- **High Gain-Bandwidth
Product:** 9.0 GHz Typical f_T

Description

Agilent's AT-42000 is a general purpose NPN bipolar transistor chip that offers excellent high frequency performance. The 4 micron emitter-to-emitter pitch enables this transistor to be used in many different functions. The 20 emitter finger interdigitated geometry yields a medium sized transistor with impedances that are easy to match for low noise and medium power applications.

This device is designed for use in low noise, wideband amplifier, mixer and oscillator applications in the VHF, UHF, and microwave frequencies. An optimum noise match near $50\ \Omega$ up to 1 GHz, makes this device easy to use as a low noise amplifier.

The AT-42000 bipolar transistor is fabricated using Agilent's 10 GHz f_T Self-Aligned-Transistor (SAT) process. The die is nitride passivated for surface protection. Excellent device uniformity, performance and reliability are produced by the use of ion-implantation, self-alignment techniques, and gold metalization in the fabrication of this device.

The recommended assembly procedure is gold-eutectic die attach at 400°C and either wedge or ball bonding using 0.7 mil gold wire. See APPLICATIONS section, "Chip Use".

Chip Outline

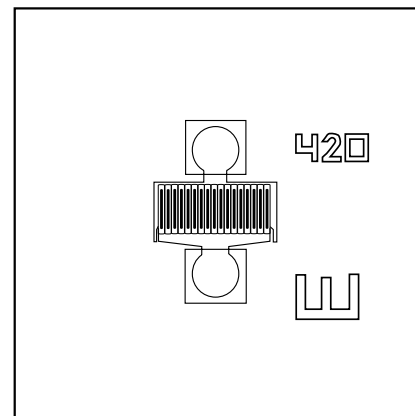

AT-42000 Absolute Maximum Ratings

Symbol	Parameter	Units	Absolute Maximum ^[1]
V _{EBO}	Emitter-Base Voltage	V	1.5
V _{CBO}	Collector-Base Voltage	V	20
V _{CEO}	Collector-Emitter Voltage	V	12
I _C	Collector Current	mA	80
P _T	Power Dissipation ^[2,3]	mW	600
T _j	Junction Temperature	°C	200
T _{STG}	Storage Temperature	°C	-65 to 200

Thermal Resistance^[2,4]:

$$\theta_{jc} = 70^{\circ}\text{C/W}$$

Notes:

1. Permanent damage may occur if any of these limits are exceeded.
2. T_{Mounting Surface} = 25°C.
3. Derate at 14.3 mW/°C for T_{Mounting Surface} > 158°C.
4. The small spot size of this technique results in a higher, though more accurate determination of θ_{jc} than do alternate methods. See MEASUREMENTS section "Thermal Resistance" for more information.

Part Number Ordering Information

Part Number	Devices Per Tray
AT-42000-GP4	100

Electrical Specifications, T_A = 25°C

Symbol	Parameters and Test Conditions ^[1]	Units	Min.	Typ.	Max.
S _{21E} ²	Insertion Power Gain; V _{CE} = 8 V, I _C = 35 mA	f = 2.0 GHz f = 4.0 GHz	dB	11.5 5.5	
P _{1dB}	Power Output @ 1 dB Gain Compression V _{CE} = 8 V, I _C = 35 mA	f = 2.0 GHz f = 4.0 GHz	dBm	21.0 20.5	
G _{1dB}	1 dB Compressed Gain; V _{CE} = 8 V, I _C = 35 mA	f = 2.0 GHz f = 4.0 GHz	dB	15.0 10.0	
NF _O	Optimum Noise Figure; V _{CE} = 8 V, I _C = 10 mA	f = 2.0 GHz f = 4.0 GHz	dB	1.9 3.0	
G _A	Gain @ NF _O ; V _{CE} = 8 V, I _C = 10 mA	f = 2.0 GHz f = 4.0 GHz	dB	14.0 10.5	
f _T	Gain Bandwidth Product; V _{CE} = 8 V, I _C = 35 mA		GHz	9.0	
h _{FE}	Forward Current Transfer Ratio; V _{CE} = 8 V, I _C = 35 mA		—	30	270
I _{CBO}	Collector Cutoff Current; V _{CB} = 8 V		μA		0.2
I _{EBO}	Emitter Cutoff Current; V _{EB} = 1 V		μA		2.0
C _{CB}	Collector Base Capacitance ^[2] ; V _{CB} = 8 V, f = 1 MHz		pF	0.23	

Notes:

1. RF performance is determined by packaging and testing 10 devices per wafer.
2. For this test, the emitter is grounded.

AT-42000 Typical Performance, $T_A = 25^\circ\text{C}$

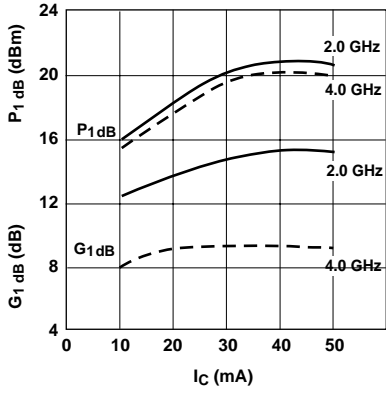

Figure 1. Output Power and 1 dB Compressed Gain vs. Collector Current and Frequency. $V_{CE} = 8\text{ V}$.

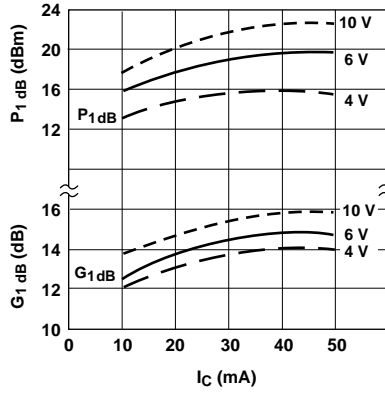

Figure 2. Output Power and 1 dB Compressed Gain vs. Collector Current and Voltage. $f = 2.0\text{ GHz}$.

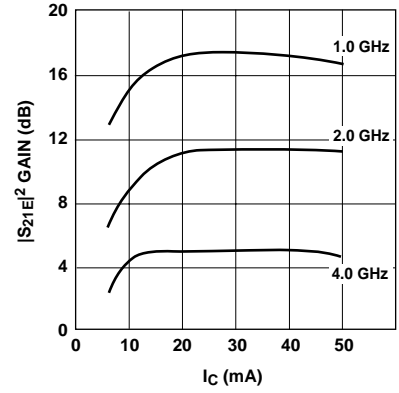

Figure 3. Insertion Power Gain vs. Collector Current and Frequency. $V_{CE} = 8\text{ V}$.

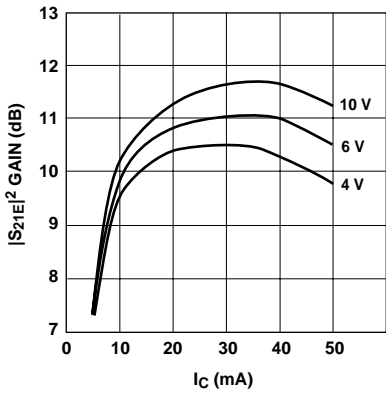

Figure 4. Insertion Power Gain vs. Collector Current and Voltage. $f = 2.0\text{ GHz}$.

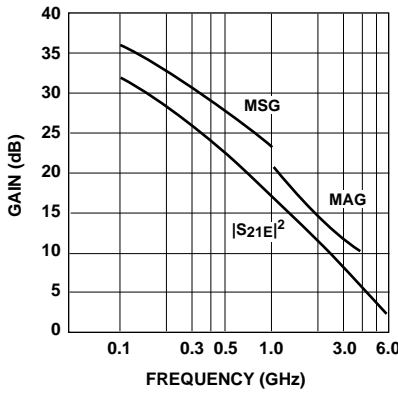

Figure 5. Insertion Power Gain, Maximum Available Gain and Maximum Stable Gain vs. Frequency. $V_{CE} = 8\text{ V}$, $I_C = 35\text{ mA}$.

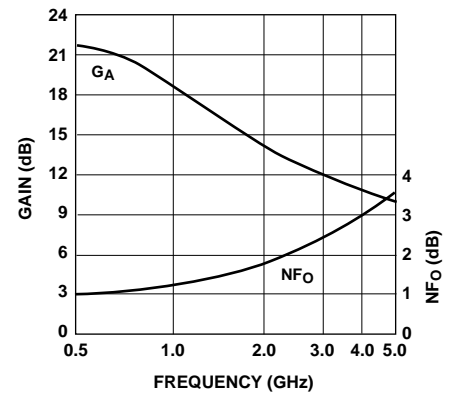

Figure 6. Noise Figure and Associated Gain vs. Frequency. $V_{CE} = 8\text{ V}$, $I_C = 10\text{ mA}$.

AT-42000 Typical Scattering Parameters,Common Emitter, $Z_O = 50 \Omega$, $T_A = 25^\circ\text{C}$, $V_{CE} = 8 \text{ V}$, $I_C = 10 \text{ mA}$

Freq. GHz	S_{11}		S_{21}			S_{12}			S_{22}	
	Mag.	Ang.	dB	Mag.	Ang.	dB	Mag.	Ang.	Mag.	Ang.
0.1	.70	-50	28.0	25.19	155	-37.7	.013	71	.92	-14
0.5	.67	-136	20.9	11.04	108	-30.5	.030	43	.57	-27
1.0	.66	-166	15.7	6.08	90	-28.9	.036	47	.50	-24
1.5	.66	-173	12.1	4.02	86	-28.2	.039	52	.48	-23
2.0	.66	179	9.8	3.09	82	-27.5	.042	57	.47	-23
2.5	.67	170	7.8	2.46	74	-26.0	.050	66	.47	-23
3.0	.67	165	6.3	2.08	68	-24.7	.058	72	.47	-26
3.5	.70	157	5.1	1.80	61	-23.4	.068	77	.47	-28
4.0	.70	151	3.9	1.56	57	-21.8	.081	82	.48	-30
4.5	.71	145	2.9	1.40	51	-20.7	.092	86	.50	-34
5.0	.73	138	1.9	1.24	41	-19.3	.109	87	.51	-38
5.5	.74	132	1.2	1.15	36	-17.2	.138	88	.51	-50
6.0	.76	129	0.2	1.02	32	-16.3	.154	87	.53	-56

AT-42000 Typical Scattering Parameters,Common Emitter, $Z_O = 50 \Omega$, $T_A = 25^\circ\text{C}$, $V_{CE} = 8 \text{ V}$, $I_C = 35 \text{ mA}$

Freq. GHz	S_{11}		S_{21}			S_{12}			S_{22}	
	Mag.	Ang.	dB	Mag.	Ang.	dB	Mag.	Ang.	Mag.	Ang.
0.1	.49	-96	33.0	44.61	143	-40.9	.009	65	.79	-24
0.5	.62	-163	22.8	13.87	98	-34.4	.019	58	.42	-26
1.0	.63	179	17.2	7.25	86	-30.5	.030	70	.38	-22
1.5	.63	171	13.5	4.74	78	-27.7	.041	76	.38	-23
2.0	.65	163	11.2	3.62	72	-25.4	.054	79	.38	-25
2.5	.65	159	9.3	2.90	67	-23.6	.066	82	.38	-27
3.0	.68	154	7.8	2.44	60	-22.1	.079	82	.38	-29
3.5	.67	148	6.5	2.12	57	-20.6	.093	84	.39	-32
4.0	.69	144	5.3	1.83	51	-19.7	.104	86	.40	-34
4.5	.70	139	4.4	1.65	47	-18.3	.121	86	.41	-40
5.0	.70	137	3.3	1.46	43	-17.5	.133	85	.42	-44
5.5	.72	131	2.7	1.36	38	-16.5	.149	86	.41	-48
6.0	.74	128	1.7	1.22	34	-15.7	.164	85	.44	-55

A model for this device is available in the DEVICE MODELS section.

AT-42000 Noise Parameters: $V_{CE} = 8 \text{ V}$, $I_C = 10 \text{ mA}$

Freq. GHz	N_{F0} dB	Γ_{opt}		$R_N/50$
		Mag	Ang	
0.1	1.0	.04	13	0.13
0.5	1.1	.05	69	0.13
1.0	1.5	.09	127	0.12
2.0	1.9	.23	171	0.11
4.0	3.0	.47	-154	0.14

AT-42000 Chip Dimensions

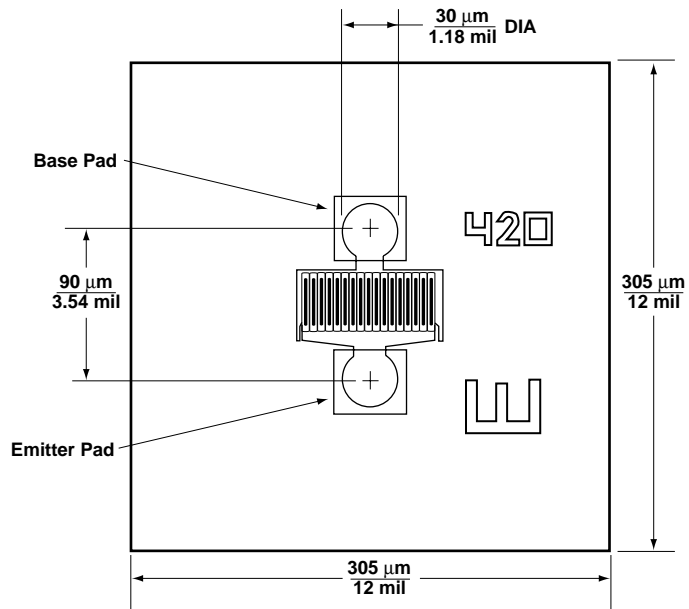

Note: Die thickness is 5 to 6 mil.



Agilent Technologies

Innovating the HP Way

www.semiconductor.agilent.com

Data subject to change.

Copyright © 1999 Agilent Technologies

5965-8909E (11/99)