

High performance dual operational amplifier

Features

- Low power consumption
- Short-circuit protection
- Low distortion, low noise
- High gain-bandwidth product
- High channel separation

Description

The LS204 is a high performance dual operational amplifier with frequency and phase compensation built into the chip. The internal phase compensation allows stable operation as voltage follower in spite of its high gain-bandwidth product.

The circuit presents very stable electrical characteristics over the entire supply voltage range, and is particularly intended for professional and telecom applications (such as active filtering).

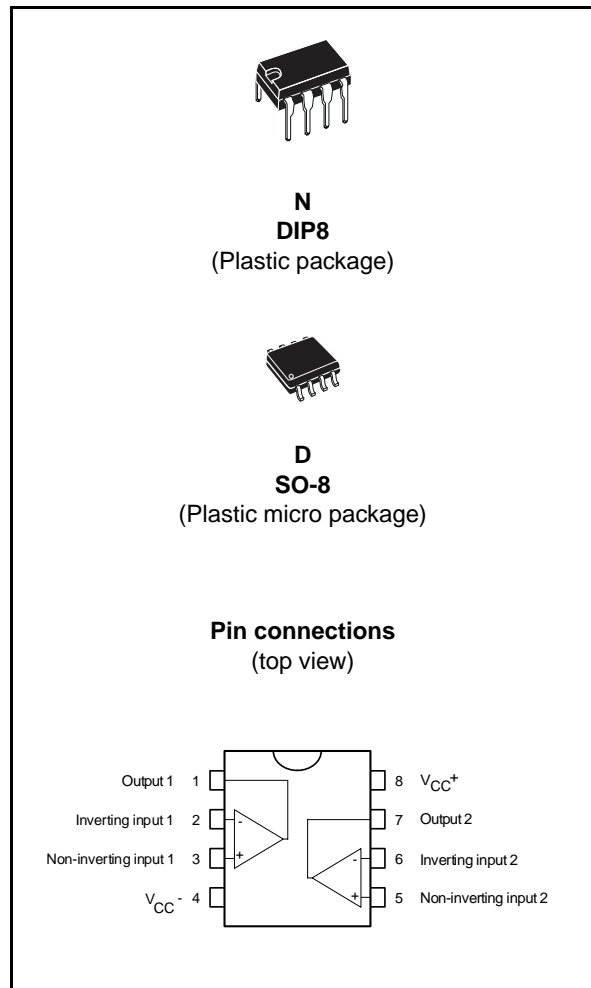

1 Circuit schematics

Figure 1. Schematic diagram (1/2 LS204)

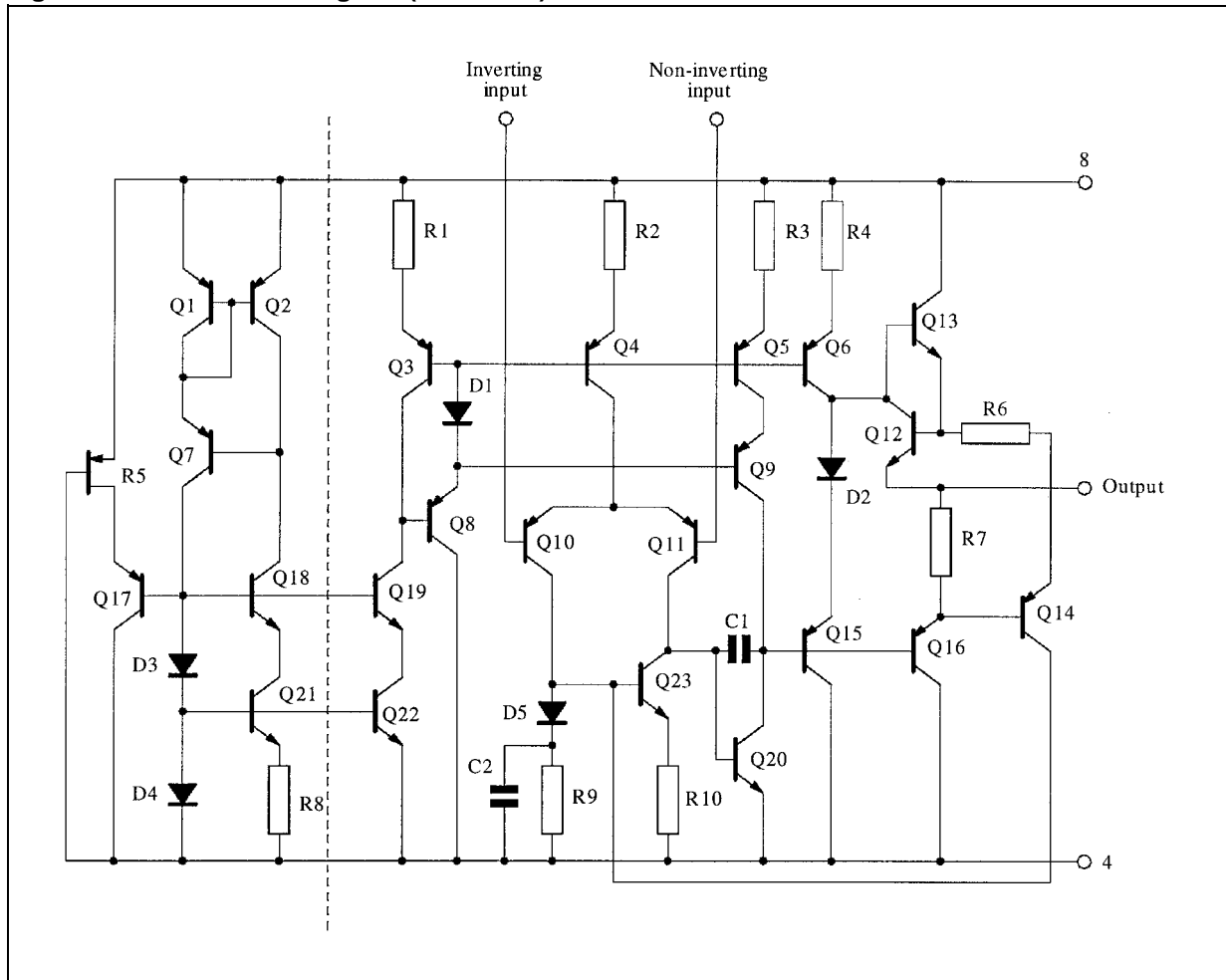

2 Absolute maximum ratings and operating conditions

Table 1. Absolute maximum ratings

Symbol	Parameter	Value	Unit
V_{CC}	Supply voltage ⁽¹⁾	± 18	V
V_i	Input voltage ⁽²⁾	$\pm V_{CC}$	V
V_{id}	Differential input voltage ⁽³⁾	$\pm(V_{CC}-1)$	V
R_{thja}	Thermal resistance junction to ambient ⁽⁴⁾		$^{\circ}\text{C}/\text{W}$
	SO-8 DIP8	125 85	
R_{thjc}	Thermal resistance junction to case ⁽⁴⁾		$^{\circ}\text{C}/\text{W}$
	SO-8 DIP8	40 41	
	Output short-circuit duration ⁽⁵⁾	Infinite	
T_j	Junction temperature	150	$^{\circ}\text{C}$
T_{stg}	Storage temperature range	-65 to +150	$^{\circ}\text{C}$
ESD	HBM: human body model ⁽⁶⁾	2	kV
	MM: machine model ⁽⁷⁾	200	V
	CDM: charged device model ⁽⁸⁾	1.5	kV

- All voltage values, except differential voltage, are with respect to the zero reference level (ground) of the supply voltages where the zero reference level is the midpoint between V_{CC}^+ and V_{CC}^- .
- The magnitude of the input voltage must never exceed the magnitude of the supply voltage or 15 volts, whichever is less.
- Differential voltages are the non-inverting input terminal with respect to the inverting input terminal.
- Short-circuits can cause excessive heating and destructive dissipation. Values are typical.
- The output may be shorted to ground or to either supply. Temperature and/or supply voltages must be limited to ensure that the dissipation rating is not exceeded.
- Human body model: A 100 pF capacitor is charged to the specified voltage, then discharged through a 1.5 k Ω resistor between two pins of the device. This is done for all couples of connected pin combinations while the other pins are floating.
- Machine model: A 200 pF capacitor is charged to the specified voltage, then discharged directly between two pins of the device with no external series resistor (internal resistor < 5 Ω). This is done for all couples of connected pin combinations while the other pins are floating.
- Charged device model: all pins and the package are charged together to the specified voltage and then discharged directly to the ground through only one pin. This is done for all pins.

Table 2. Operating conditions

Symbol	Parameter	LS204C	LS204I	Unit
V_{CC}	Supply voltage	6 to 30		V
V_{icm}	Common mode input voltage range	$V_{DD}+1.5$ to $V_{CC}-1.5$		V
T_{oper}	Operating free-air temperature range	0 to +70	-40 to +105	$^{\circ}\text{C}$

3 Electrical characteristics

Table 3. Electrical characteristics at $V_{CC} = \pm 15\text{ V}$, $T_{amb} = +25^\circ\text{ C}$ (unless otherwise specified)

Symbol	Parameter	LS204I			LS204C			Unit
		Min.	Typ.	Max.	Min.	Typ.	Max.	
I_{CC}	Supply current		0.7	1.2		0.8	1.5	mA
I_{ib}	Input bias current $T_{min} < T_{amb} < T_{max}$		50	150 300		100	300 700	nA
R_i	Input resistance (F = 1kHz)		1			1		M Ω
V_{io}	Input offset voltage ($R_s \leq 10\text{k}\Omega$) $T_{min} < T_{amb} < T_{max}$		0.5	2.5 3.5		0.5	3.5 5	mV
DV_{io}	Input offset voltage drift ($R_s \leq 10\text{k}\Omega$) $T_{min} < T_{amb} < T_{max}$		5			5		$\mu\text{V}/^\circ\text{C}$
I_{io}	Input offset current $T_{min} < T_{amb} < T_{max}$		5	20 40		12	50 100	nA
DI_{io}	Input offset current drift $T_{min} < T_{amb} < T_{max}$		0.08			0.1		nA/ $^\circ\text{C}$
I_{os}	Output short-circuit current		23			23		mA
A_{vd}	Large signal voltage gain $T_{min} < T_{amb} < T_{max}$ $R_L = 2\text{k}\Omega$, $V_{CC} = \pm 15\text{V}$ $R_L = 2\text{k}\Omega$, $V_{CC} = \pm 4\text{V}$	90	100 95		86	100 95		dB
GBP	Gain bandwidth product (F = 100kHz)	1.8	3		1.5	2.5		MHz
e_n	Equivalent input noise voltage F = 1kHz, $R_s = 100\Omega$ $R_s = 50\Omega$ $R_s = 1\text{k}\Omega$ $R_s = 10\text{k}\Omega$		8 10 18			10 12 20		$\frac{\text{nV}}{\sqrt{\text{Hz}}}$
THD	Total harmonic distortion (F = 1kHz, $A_v = 20\text{dB}$, $R_L = 2\text{k}\Omega$, $V_o = 2V_{pp}$)		0.03			0.03		%
$\pm V_{opp}$	Output voltage swing $R_L = 2\text{k}\Omega$, $V_{CC} = \pm 15\text{V}$ $R_L = 2\text{k}\Omega$, $V_{CC} = \pm 4\text{V}$	± 13			± 13			V
V_{opp}	Large signal voltage swing $R_L = 10\text{k}\Omega$, F = 10kHz		28			28		V_{pp}
SR	Slew rate ($R_L = 2\text{k}\Omega$, unity gain)	0.8	1.5			1		V/ μs
SVR	Supply voltage rejection ratio $T_{min} < T_{amb} < T_{max}$	90			86			dB
CMR	Common mode rejection ratio $V_{ic} = \pm 10\text{V}$ $T_{min} < T_{amb} < T_{max}$	90			86			dB
V_{o1}/V_{o2}	Channel separation (F = 1 kHz)	100	120			120		dB

Figure 2. Supply current versus supply voltage

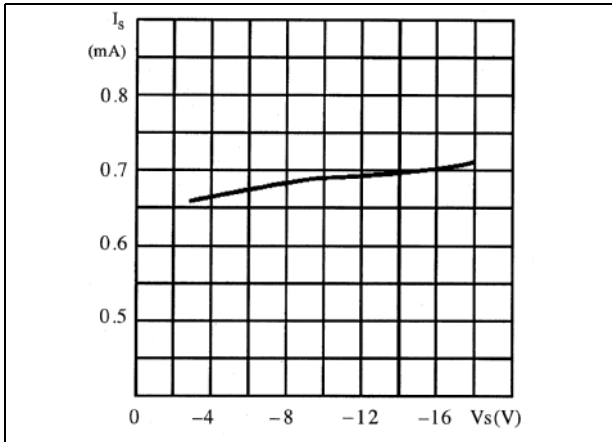

Figure 3. Supply current versus ambient temperature

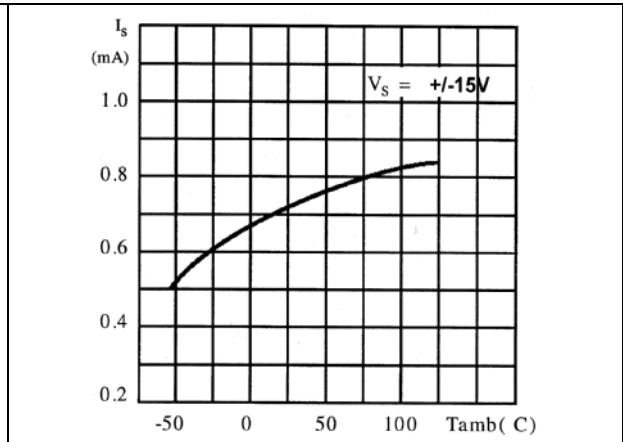

Figure 4. Output short circuit current versus ambient temperature

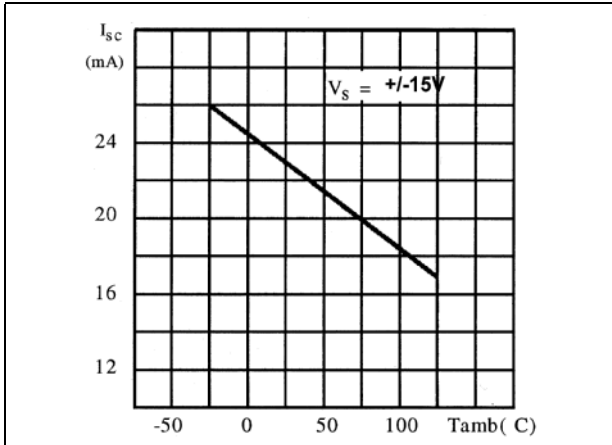

Figure 5. Open loop frequency and phase response

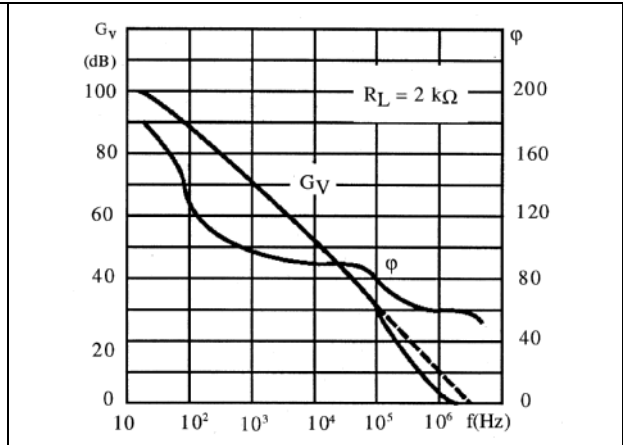

Figure 6. Output loop gain versus ambient temperature

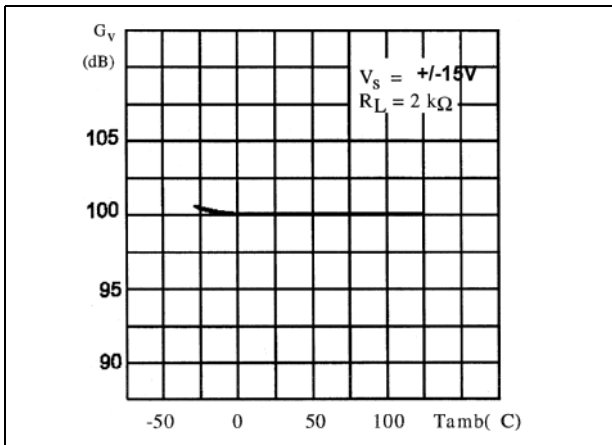

Figure 7. Supply voltage rejection versus frequency

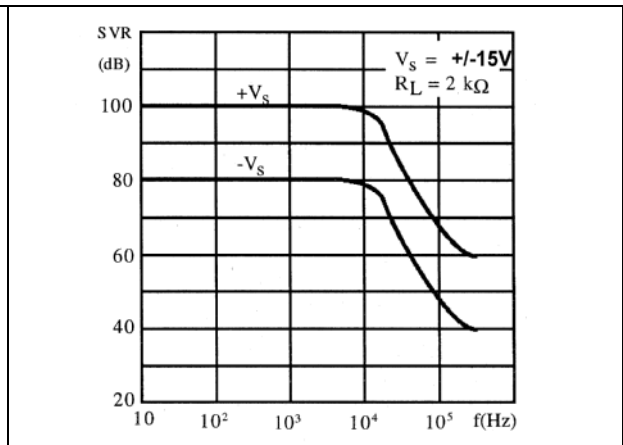

Figure 8. Large signal frequency response

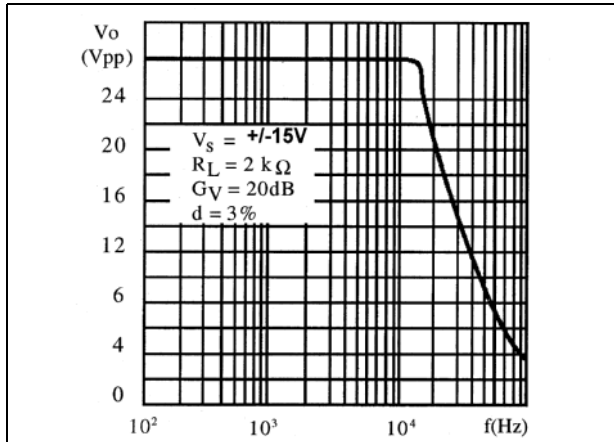

Figure 9. Output voltage swing versus load resistance

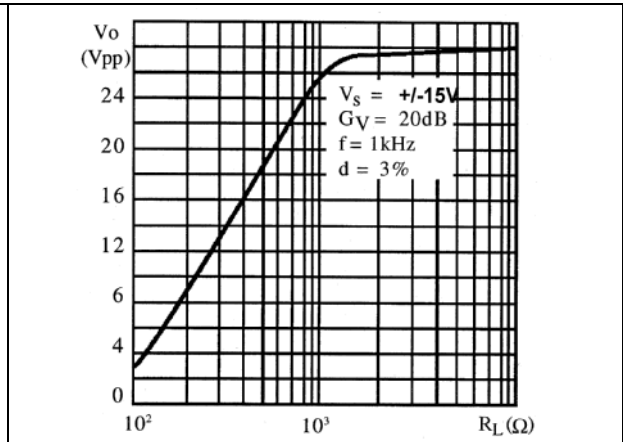

Figure 10. Total input noise versus frequency

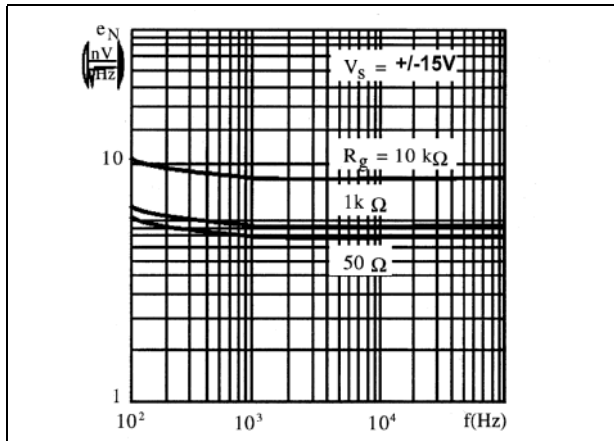

Figure 11. Amplitude response

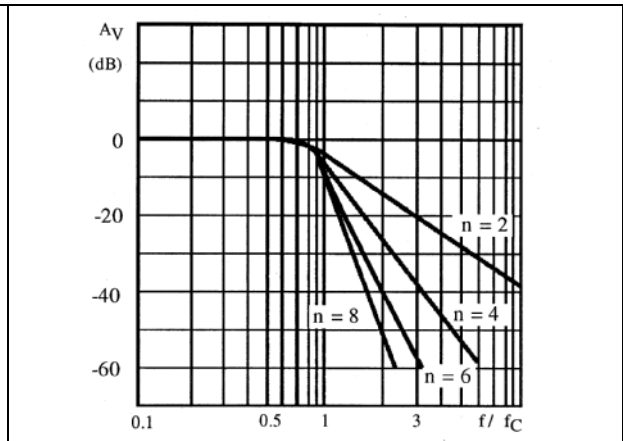
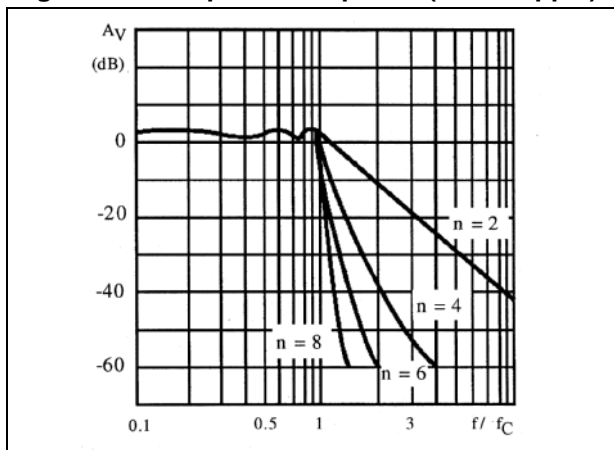

Figure 12. Amplitude response ($\pm 1\text{dB}$ ripple)



4 Application information for active low-pass filters

4.1 Butterworth

The Butterworth is a "maximally flat" amplitude response filter ([Figure 11](#)).

Butterworth filters are used for filtering signals in data acquisition systems to prevent aliasing errors in samples-data applications and for general purpose low-pass filtering.

The cut-off frequency, F_c , is the frequency at which the amplitude response is down 3 dB. The attenuation rate beyond the cut-off frequency is n dB per octave of frequency, where n is the order (number of poles) of the filter.

Other characteristics:

- Flattest possible amplitude response
- Excellent gain accuracy at low frequency end of passband

4.2 Bessel

The Bessel is a type of "linear phase" filter.

Because of their linear phase characteristics, these filters approximate a constant time delay over a limited frequency range. Bessel filters pass transient waveforms with a minimum of distortion. They are also used to provide time delays for low pass filtering of modulated waveforms and as a "running average" type filter.

The maximum phase shift is $\frac{-n\pi}{2}$ radians,

where n is the order (number of poles) of the filter. The cut-off frequency, F_c , is defined as the frequency at which the phase shift is one half of this value.

For accurate delay, the cut-off frequency should be twice the maximum signal frequency.

[Table 4](#) can be used to obtain the -3 dB frequency of the filter.

Table 4. -3 dB frequency of the filter

	2 Poles	4 Poles	6 Poles	8 Poles
-3 dB frequency	0.77 F_c	0.67 F_c	0.57 F_c	0.50 F_c

Other characteristics:

- Selectivity not as great as Chebyshev or Butterworth
- Very little overshoot response to step inputs
- Fast rise time

4.3 Chebyshev

Chebyshev filters have greater selectivity than either Bessel or Butterworth at the expense of ripple in the passband ([Figure 12](#)).

Chebyshev filters are normally designed with peak-to-peak ripple values from 0.2 dB to 2 dB.

Increased ripple in the passband allows increased attenuation above the cut-off frequency. The cut-off frequency is defined as the frequency at which the amplitude response passes through the specified maximum ripple band and enters the stop band.

Other characteristics:

- Greater selectivity
- Very non-linear phase response
- High overshoot response to step inputs

Table 5 shows the typical overshoot and setting time response of the low pass filters to a step input.

Table 5. Overshoot and setting time response of low pass filters to step input

	Number of poles	Peak overshoot	Settling time (% of final value)		
		% Overshoot	±1%	±0.1%	±0.01%
Butterworth	2	4	1.1Fc sec.	1.7Fc sec.	1.9Fc sec.
	4	11	1.7/Fc	2.8/Fc	3.8/Fc
	6	14	2.4/Fc	3.9S/Fc	5.0S/Fc
	8	14	3.1/Fc	5.1/Fc	7.1/Fc
Bessel	2	0.4	0.8/Fc	1.4/Fc	1.7/Fc
	4	0.8	1.0/Fc	1.8/Fc	2.4/Fc
	6	0.6	1.3/Fc	2.1/Fc	2.7/Fc
	8	0.1	1.6/Fc	2.3/Fc	3.2/Fc
Chebyshev (ripple ±0.25dB)	2	11	1.1/Fc	1.6/Fc	-
	4	18	3.0/Fc	5.4/Fc	-
	6	21	5.9/Fc	10.4/Fc	-
	8	23	8.4/Fc	16.4/Fc	-
Chebyshev (ripple ±1dB)	2	21	1.6/Fc	2.7/Fc	-
	4	28	4.8/Fc	8.4/Fc	-
	6	32	8.2/Fc	16.3/Fc	-
	8	34	11.6/Fc	24.8/Fc	-

4.4 Design of 2nd order active low pass filter (Sallen and Key configuration unity gain op-amp)

For fixed R = R1 = R2, we have (see Figure 13):

$$C1 = \frac{1}{R} \frac{\zeta}{\omega_c}$$

$$C2 = \frac{1}{R} \frac{1}{\xi \omega_c}$$

Figure 13. Filter configuration

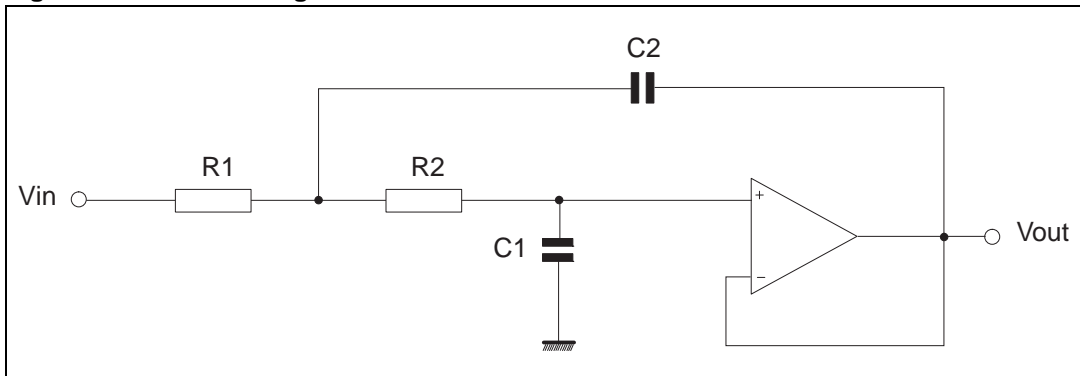

Three parameters are needed to characterize the frequency and phase response of a 2nd order active filter:

- the gain (G_v),
- the damping factor (ξ) or the Q factor ($Q = 2 \xi^{-1}$),
- the cut-off frequency (F_c).

The higher order response is obtained with a series of 2nd order sections. A simple RC section is introduced when an odd filter is required.

The choice of ξ (or Q factor) determines the filter response (see [Table 6](#)).

Table 6. Filter response to ξ or Q factor

Filter response	ξ	Q	Cut-off frequency (F_c)
Bessel	$\frac{\sqrt{3}}{2}$	$\frac{\sqrt{1}}{3}$	Frequency at which phase shift is -90°
Butterworth	$\frac{\sqrt{2}}{2}$	$\frac{\sqrt{1}}{2}$	Frequency at which $G_v = -3$ dB
Chebyshev	$\frac{\sqrt{2}}{2}$	$\frac{\sqrt{1}}{2}$	Frequency at which the amplitude response passes through specified max. ripple band and enters the stop bank.

4.5 Example

Figure 14. 5th order low-pass filter (Butterworth) with unity gain configuration

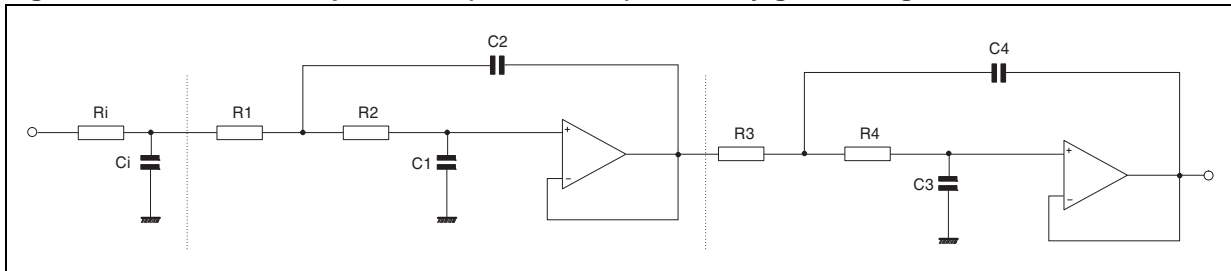

In the circuit of [Figure 14](#), for $F_c = 3.4 \text{ kHz}$ and $R_i = R_1 = R_2 = R_3 = 10 \text{ kW}$, we obtain:

$$C_i = 1.354 \frac{1}{R} \frac{1}{2\pi f_c} = 6.33 \text{ nF}$$

$$C_1 = 0.421 \frac{1}{R} \frac{1}{2\pi f_c} = 1.97 \text{ nF}$$

$$C_2 = 1.753 \frac{1}{R} \frac{1}{2\pi f_c} = 8.20 \text{ nF}$$

$$C_3 = 0.309 \frac{1}{R} \frac{1}{2\pi f_c} = 1.45 \text{ nF}$$

$$C_4 = 3.325 \frac{1}{R} \frac{1}{2\pi f_c} = 15.14 \text{ nF}$$

The attenuation of the filter is 30 dB at 6.8 kHz and better than 60 dB at 15 kHz.

The same method, referring to [Table 7](#) and [Figure 15](#) is used to design high-pass filters. In this case the damping factor is found by taking the reciprocal of the numbers in [Table 7](#).

For $F_c = 5 \text{ kHz}$ and $C_i = C_1 = C_2 = C_3 = 1 \text{ nF}$ we obtain:

$$R_i = \frac{1}{0.354} \frac{1}{C} \frac{1}{2\pi f_c} = 25.5 \text{ k}\Omega$$

$$R_1 = \frac{1}{0.421} \frac{1}{C} \frac{1}{2\pi f_c} = 75.6 \text{ k}\Omega$$

$$R_2 = \frac{1}{1.753} \frac{1}{C} \frac{1}{2\pi f_c} = 18.2 \text{ k}\Omega$$

$$R_3 = \frac{1}{0.309} \frac{1}{C} \frac{1}{2\pi f_c} = 103 \text{ k}\Omega$$

$$R_4 = \frac{1}{3.325} \frac{1}{C} \frac{1}{2\pi f_c} = 9.6 \text{ k}\Omega$$

Figure 15. 5th order high-pass filter (Butterworth) with unity gain configuration

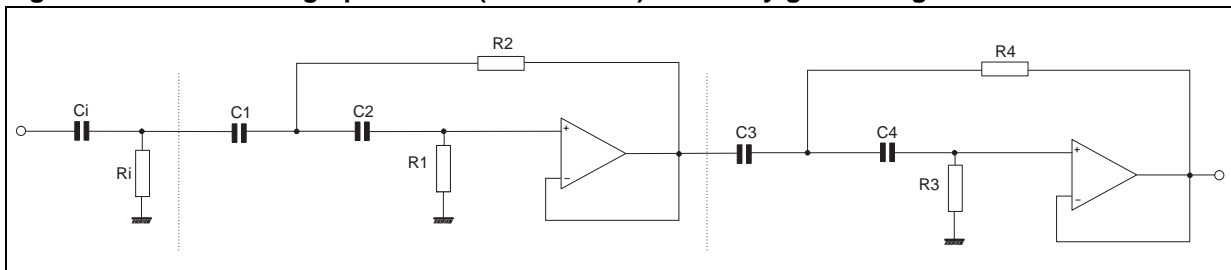

Table 7. Damping factor for low-pass Butterworth filters

Order	Ci	C1	C2	C3	C4	C5	C6	C7	C8
2		0.707	1.41						
3	1.392	0.202	3.54						
4		0.92	1.08	0.38	2.61				
5	1.354	0.421	1.75	0.309	3.235				
6		0.966	1.035	0.707	1.414	0.259	3.86		
7	1.336	0.488	1.53	0.623	1.604	0.222	4.49		
8		0.98	1.02	0.83	1.20	0.556	1.80	0.195	5.125

5 Package information

In order to meet environmental requirements, STMicroelectronics offers these devices in ECOPACK[®] packages. These packages have a lead-free second level interconnect. The category of second level interconnect is marked on the package and on the inner box label, in compliance with JEDEC Standard JESD97. The maximum ratings related to soldering conditions are also marked on the inner box label. ECOPACK is an STMicroelectronics trademark. ECOPACK specifications are available at: www.st.com.

5.1 DIP8 package information

Figure 16. DIP8 package mechanical drawing

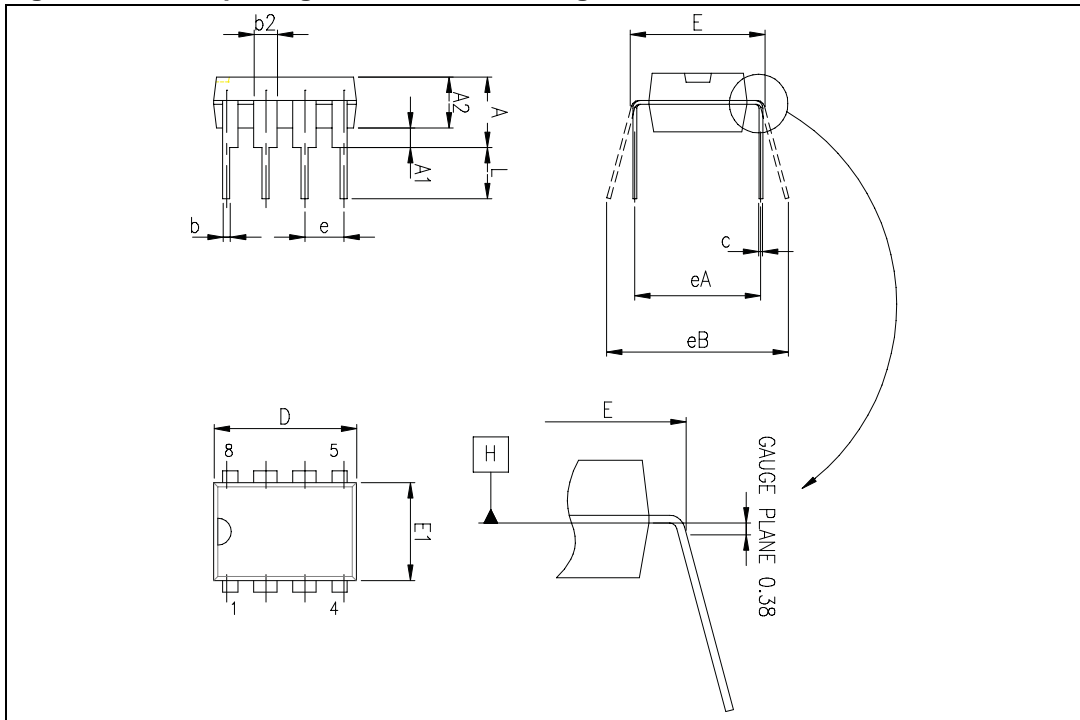

Table 8. DIP8 package mechanical data

Ref.	Dimensions					
	Millimeters			Inches		
	Min.	Typ.	Max.	Min.	Typ.	Max.
A			5.33			0.210
A1	0.38			0.015		
A2	2.92	3.30	4.95	0.115	0.130	0.195
b	0.36	0.46	0.56	0.014	0.018	0.022
b2	1.14	1.52	1.78	0.045	0.060	0.070
c	0.20	0.25	0.36	0.008	0.010	0.014
D	9.02	9.27	10.16	0.355	0.365	0.400
E	7.62	7.87	8.26	0.300	0.310	0.325
E1	6.10	6.35	7.11	0.240	0.250	0.280
e		2.54			0.100	
eA		7.62			0.300	
eB			10.92			0.430
L	2.92	3.30	3.81	0.115	0.130	0.150

5.2 SO-8 package information

Figure 17. SO-8 package mechanical drawing

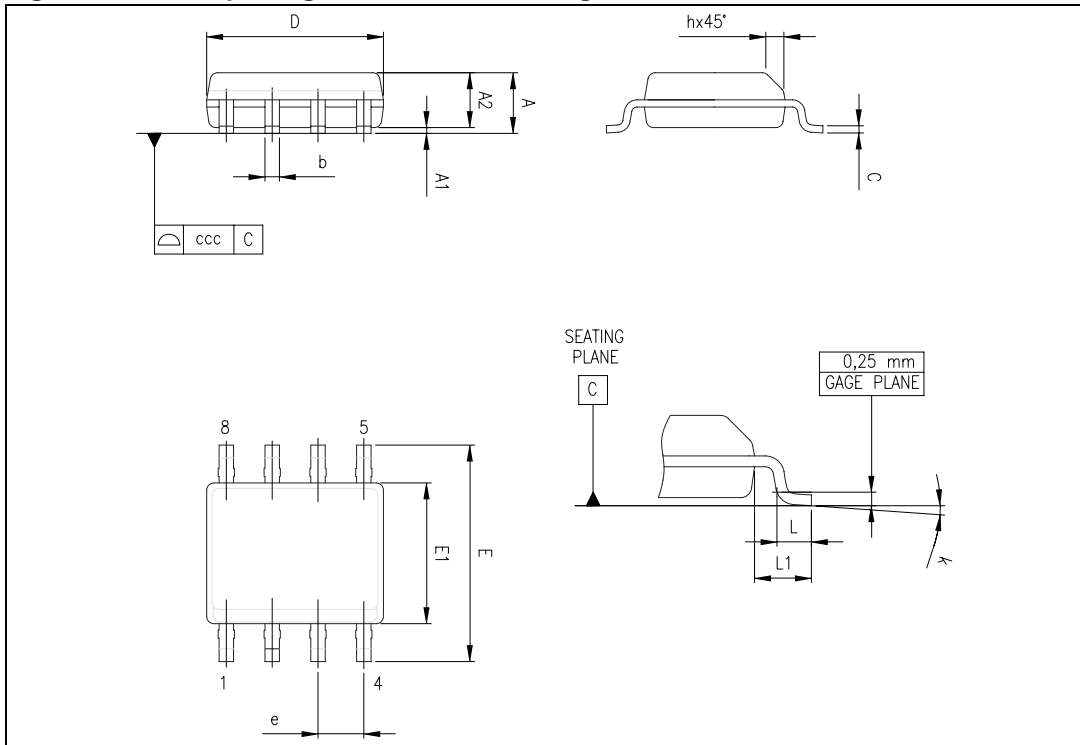

Table 9. SO-8 package mechanical data

Ref.	Dimensions					
	Millimeters			Inches		
	Min.	Typ.	Max.	Min.	Typ.	Max.
A			1.75			0.069
A1	0.10		0.25	0.004		0.010
A2	1.25			0.049		
b	0.28		0.48	0.011		0.019
c	0.17		0.23	0.007		0.010
D	4.80	4.90	5.00	0.189	0.193	0.197
E	5.80	6.00	6.20	0.228	0.236	0.244
E1	3.80	3.90	4.00	0.150	0.154	0.157
e		1.27			0.050	
h	0.25		0.50	0.010		0.020
L	0.40		1.27	0.016		0.050
k	1°		8°	1°		8°
ccc			0.10			0.004

6 Ordering information

Table 10. Order codes

Order code	Temperature range	Package	Packing	Marking
LS204CN	0°C, +70°C	DIP8	Tape	LS204CN
LS204CD LS204CDT		SO-8	Tape or Tape & reel	204C
LS204IN	-40°C, +105°C	DIP8	Tape	LS204IBN
LS204ID LS204IDT		SO-8	Tape or Tape & reel	204I
LS204IYD ⁽¹⁾ LS204IYDT ⁽¹⁾		SO-8 (Automotive grade)	Tape or Tape & reel	204IYD

1. Qualification and characterization according to AEC Q100 and Q003 or equivalent, advanced screening according to AEC Q001 & Q 002 or equivalent are on-going.

7 Revision history

Table 11. Document revision history

Date	Revision	Changes
29-Nov-2001	1	Initial release.
4-Jun-2008	2	Updated document format. Added automotive grade order codes.

Please Read Carefully:

Information in this document is provided solely in connection with ST products. STMicroelectronics NV and its subsidiaries ("ST") reserve the right to make changes, corrections, modifications or improvements, to this document, and the products and services described herein at any time, without notice.

All ST products are sold pursuant to ST's terms and conditions of sale.

Purchasers are solely responsible for the choice, selection and use of the ST products and services described herein, and ST assumes no liability whatsoever relating to the choice, selection or use of the ST products and services described herein.

No license, express or implied, by estoppel or otherwise, to any intellectual property rights is granted under this document. If any part of this document refers to any third party products or services it shall not be deemed a license grant by ST for the use of such third party products or services, or any intellectual property contained therein or considered as a warranty covering the use in any manner whatsoever of such third party products or services or any intellectual property contained therein.

UNLESS OTHERWISE SET FORTH IN ST'S TERMS AND CONDITIONS OF SALE ST DISCLAIMS ANY EXPRESS OR IMPLIED WARRANTY WITH RESPECT TO THE USE AND/OR SALE OF ST PRODUCTS INCLUDING WITHOUT LIMITATION IMPLIED WARRANTIES OF MERCHANTABILITY, FITNESS FOR A PARTICULAR PURPOSE (AND THEIR EQUIVALENTS UNDER THE LAWS OF ANY JURISDICTION), OR INFRINGEMENT OF ANY PATENT, COPYRIGHT OR OTHER INTELLECTUAL PROPERTY RIGHT.

UNLESS EXPRESSLY APPROVED IN WRITING BY AN AUTHORIZED ST REPRESENTATIVE, ST PRODUCTS ARE NOT RECOMMENDED, AUTHORIZED OR WARRANTED FOR USE IN MILITARY, AIR CRAFT, SPACE, LIFE SAVING, OR LIFE SUSTAINING APPLICATIONS, NOR IN PRODUCTS OR SYSTEMS WHERE FAILURE OR MALFUNCTION MAY RESULT IN PERSONAL INJURY, DEATH, OR SEVERE PROPERTY OR ENVIRONMENTAL DAMAGE. ST PRODUCTS WHICH ARE NOT SPECIFIED AS "AUTOMOTIVE GRADE" MAY ONLY BE USED IN AUTOMOTIVE APPLICATIONS AT USER'S OWN RISK.

Resale of ST products with provisions different from the statements and/or technical features set forth in this document shall immediately void any warranty granted by ST for the ST product or service described herein and shall not create or extend in any manner whatsoever, any liability of ST.

ST and the ST logo are trademarks or registered trademarks of ST in various countries.

Information in this document supersedes and replaces all information previously supplied.

The ST logo is a registered trademark of STMicroelectronics. All other names are the property of their respective owners.

© 2008 STMicroelectronics - All rights reserved

STMicroelectronics group of companies

Australia - Belgium - Brazil - Canada - China - Czech Republic - Finland - France - Germany - Hong Kong - India - Israel - Italy - Japan - Malaysia - Malta - Morocco - Singapore - Spain - Sweden - Switzerland - United Kingdom - United States of America

www.st.com