

THS4041, THS4042 165-MHz C-STABLE HIGH-SPEED AMPLIFIERS

SLOS237B–MAY 1999 – REVISED FEBRUARY 2000

- **C-Stable Amplifiers Drive Any Capacitive Load**
- **High Speed**
 - 165 MHz Bandwidth (–3 dB); $C_L = 0$ pF
 - 100 MHz Bandwidth (–3 dB); $C_L = 100$ pF
 - 35 MHz Bandwidth (–3 dB); $C_L = 1000$ pF
 - 400 V/ μ s Slew Rate
- **Unity Gain Stable**
- **High Output Drive, $I_O = 100$ mA (typ)**
- **Very Low Distortion**
 - THD = –75 dBc (f = 1 MHz, $R_L = 150 \Omega$)
 - THD = –89 dBc (f = 1 MHz, $R_L = 1$ k Ω)
- **Wide Range of Power Supplies**
 - $V_{CC} = \pm 5$ V to ± 15 V
- **Available in Standard SOIC or MSOP PowerPAD™ Package**
- **Evaluation Module Available**

description

The THS4041 and THS4042 are single/dual, high-speed voltage feedback amplifiers capable of driving any capacitive load. This makes them ideal for a wide range of applications including driving video lines or buffering ADCs. The devices feature high 165-MHz bandwidth and 400-V/ μ sec slew rate. The THS4041/2 are stable at all gains for both inverting and noninverting configurations. For video applications, the THS4041/2 offer excellent video performance with 0.01% differential gain error and 0.01° differential phase error. These amplifiers can drive up to 100 mA into a 20- Ω load and operate off power supplies ranging from ± 5 V to ± 15 V.

RELATED DEVICES

RELATED DEVICES	
DEVICE	DESCRIPTION
THS4011/2	290-MHz Low Distortion High-Speed Amplifier
THS4031/2	100-MHz Low Noise High-Speed Amplifier
THS4081/2	175-MHz Low Power High-Speed Amplifiers

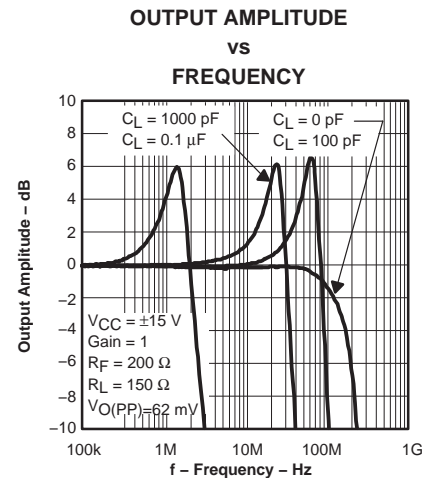
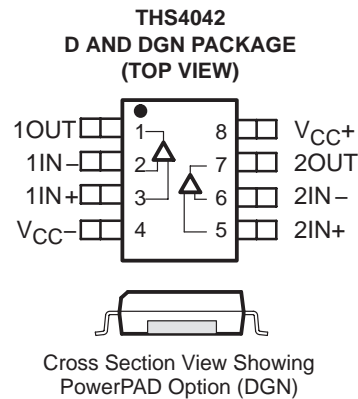
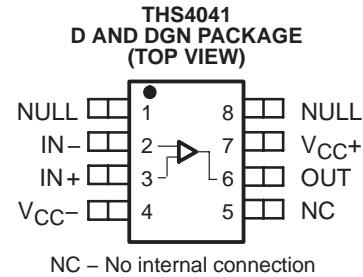

CAUTION: The THS4041 and THS4042 provide ESD protection circuitry. However, permanent damage can still occur if this device is subjected to high-energy electrostatic discharges. Proper ESD precautions are recommended to avoid any performance degradation or loss of functionality.



Please be aware that an important notice concerning availability, standard warranty, and use in critical applications of Texas Instruments semiconductor products and disclaimers thereto appears at the end of this data sheet.

PowerPAD is a trademark of Texas Instruments Incorporated.

PRODUCTION DATA information is current as of publication date. Products conform to specifications per the terms of Texas Instruments standard warranty. Production processing does not necessarily include testing of all parameters.



POST OFFICE BOX 655303 • DALLAS, TEXAS 75265

Copyright © 2000, Texas Instruments Incorporated

THS4041, THS4042 165-MHz C-STABLE HIGH-SPEED AMPLIFIERS

SLOS237B–MAY 1999 – REVISED FEBRUARY 2000

AVAILABLE OPTIONS

T _A	NUMBER OF CHANNELS	PACKAGED DEVICES		MSOP SYMBOL	EVALUATION MODULE
		PLASTIC SMALL OUTLINE† (D)	PLASTIC MSOP† (DGN)		
0°C to 70°C	1	THS4041CD	THS4041CDGN	ACO	THS4041EVM
	2	THS4042CD	THS4042CDGN	ACC	THS4042EVM
–40°C to 85°C	1	THS4041D	THS4041DGN	ACP	—
	2	THS4042ID	THS4042IDGN	ACD	—

† The D and DGN packages are available taped and reeled. Add an R suffix to the device type (i.e., THS4041CDGNR).

functional block diagram

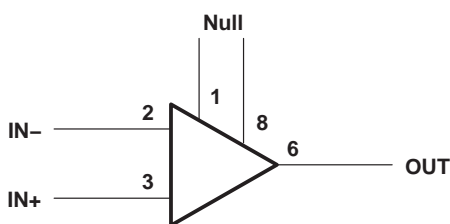

Figure 2. THS4041 – Single Channel

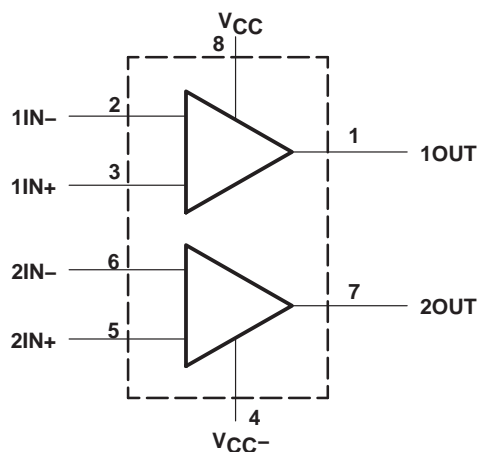

Figure 1. THS4042 – Dual Channel

absolute maximum ratings over operating free-air temperature (unless otherwise noted)†

Supply voltage, V _{CC}	±16.5 V
Input voltage, V _I	±V _{CC}
Output current, I _O	150 mA
Differential input voltage, V _{IO}	±4 V
Continuous total power dissipation	See Dissipation Rating Table
Maximum junction temperature, T _J	150°C
Operating free-air temperature, T _A : C-suffix	0°C to 70°C
I-suffix	–40°C to 85°C
Storage temperature, T _{stg}	–65°C to 150°C
Lead temperature 1,6 mm (1/16 inch) from case for 10 seconds	300°C

† Stresses beyond those listed under “absolute maximum ratings” may cause permanent damage to the device. These are stress ratings only and functional operation of the device at these or any other conditions beyond those indicated under “recommended operating conditions” is not implied. Exposure to absolute-maximum-rated conditions for extended periods may affect device reliability.

THS4041, THS4042 165-MHz C-STABLE HIGH-SPEED AMPLIFIERS

SLOS237B–MAY 1999 – REVISED FEBRUARY 2000

DISSIPATION RATING TABLE

PACKAGE	θ_{JA} (°C/W)	θ_{JC} (°C/W)	$T_A = 25^\circ\text{C}$ POWER RATING
D	167†	38.3	740 mW
DGN‡	58.4	4.7	2.14 W

† This data was taken using the JEDEC standard Low-K test PCB. For the JEDEC proposed High-K test PCB, the θ_{JA} is 95°C/W with a power rating at $T_A = 25^\circ\text{C}$ of 1.32 W.

‡ This data was taken using 2 oz. trace and copper pad that is soldered directly to a 3 in. × 3 in. PC. For further information, refer to *Application Information* section of this data sheet.

recommended operating conditions

		MIN	NOM	MAX	UNIT
Supply voltage, V_{CC+} and V_{CC-}	Dual supply	± 4.5		± 16	V
	Single supply	9		32	
Operating free-air temperature, T_A	C-suffix	0		70	°C
	I-suffix	-40		85	

electrical characteristics at $T_A = 25^\circ\text{C}$, $V_{CC} = \pm 15\text{ V}$, $R_L = 150\ \Omega$ (unless otherwise noted)

dynamic performance

PARAMETER		TEST CONDITION†		MIN	TYP	MAX	UNIT
BW	Dynamic performance small-signal bandwidth (-3 dB)	$V_{CC} = \pm 15\text{ V}$	$R_f = 200\ \Omega$	Gain = 1	165		MHz
		$V_{CC} = \pm 5\text{ V}$	$R_f = 200\ \Omega$		150		
		$V_{CC} = \pm 15\text{ V}$	$R_f = 1.3\text{ k}\Omega$	Gain = 2	60		MHz
		$V_{CC} = \pm 5\text{ V}$	$R_f = 1.3\text{ k}\Omega$		60		
	Bandwidth for 0.1 dB flatness	$V_{CC} = \pm 15\text{ V}$	$R_f = 200\ \Omega$	Gain = 1	45		MHz
		$V_{CC} = \pm 5\text{ V}$	$R_f = 200\ \Omega$		45		
Full power bandwidth§	$V_{O(pp)} = 20\text{ V}$, $V_{CC} = \pm 15\text{ V}$			6.3		MHz	
	$V_{O(pp)} = 5\text{ V}$, $V_{CC} = \pm 5\text{ V}$			20			
SR	Slew rate‡	$V_{CC} = \pm 15\text{ V}$,	20-V step,	Gain = 5	400		V/ μs
		$V_{CC} = \pm 5\text{ V}$,	5-V step,	Gain = -1	325		
t_s	Settling time to 0.1%	$V_{CC} = \pm 15\text{ V}$,	5-V step	Gain = -1	120		ns
		$V_{CC} = \pm 5\text{ V}$,	2-V step		120		
	Settling time to 0.01%	$V_{CC} = \pm 15\text{ V}$,	5-V step	Gain = -1	250		ns
		$V_{CC} = \pm 5\text{ V}$,	2-V step		280		

† Full range = 0°C to 70°C for C suffix and -40°C to 85°C for I suffix

‡ Slew rate is measured from an output level range of 25% to 75%.

§ Full power bandwidth = slew rate / $2\pi V_{O(Peak)}$.



THS4041, THS4042

165-MHz C-STABLE HIGH-SPEED AMPLIFIERS

SLOS237B–MAY 1999 – REVISED FEBRUARY 2000

electrical characteristics at $T_A = 25^\circ\text{C}$, $V_{CC} = \pm 15\text{ V}$, $R_L = 150\ \Omega$ (unless otherwise noted) (continued)

noise/distortion performance

PARAMETER		TEST CONDITIONS†			MIN	TYP	MAX	UNIT
THD	Total harmonic distortion	$V_{O(pp)} = 2\text{ V}$, $f = 1\text{ MHz}$, Gain = 2	$V_{CC} = \pm 15\text{ V}$	$R_L = 150\ \Omega$		-75		dBc
				$R_L = 1\text{ k}\Omega$		-89		
			$V_{CC} = \pm 5\text{ V}$	$R_L = 150\ \Omega$		-75		
				$R_L = 1\text{ k}\Omega$		-86		
V_n	Input voltage noise	$V_{CC} = \pm 5\text{ V}$ or $\pm 15\text{ V}$,	$f = 10\text{ kHz}$			14		$\text{nV}/\sqrt{\text{Hz}}$
I_n	Input current noise	$V_{CC} = \pm 5\text{ V}$ or $\pm 15\text{ V}$,	$f = 10\text{ kHz}$			0.9		$\text{pA}/\sqrt{\text{Hz}}$
	Differential gain error	Gain = 2, 40 IRE modulation,	NTSC, $\pm 100\text{ IRE ramp}$	$V_{CC} = \pm 15\text{ V}$		0.01%		
				$V_{CC} = \pm 5\text{ V}$		0.01%		
	Differential phase error	Gain = 2, 40 IRE modulation,	NTSC, $\pm 100\text{ IRE ramp}$	$V_{CC} = \pm 15\text{ V}$		0.01°		
				$V_{CC} = \pm 5\text{ V}$		0.02°		
	Channel-to-channel crosstalk (THS4042 only)	$V_{CC} = \pm 5\text{ V}$ or $\pm 15\text{ V}$,	$f = 1\text{ MHz}$	Gain = 2		-64		dB

† Full range = 0°C to 70°C for C suffix and -40°C to 85°C for I suffix

dc performance

PARAMETER		TEST CONDITIONS†			MIN	TYP	MAX	UNIT
	Open loop gain	$V_{CC} = \pm 15\text{ V}$, $R_L = 1\text{ k}\Omega$	$V_O = \pm 10\text{ V}$,	$T_A = 25^\circ\text{C}$	74	80		dB
				$T_A = \text{full range}$	69			
		$V_{CC} = \pm 5\text{ V}$, $R_L = 250\ \Omega$	$V_O = \pm 2.5\text{ V}$,	$T_A = 25^\circ\text{C}$	69	76		
				$T_A = \text{full range}$	66			
V_{OS}	Input offset voltage	$V_{CC} = \pm 5\text{ V}$ or $\pm 15\text{ V}$		$T_A = 25^\circ\text{C}$		2.5	10	mV
				$T_A = \text{full range}$			13	
	Offset voltage drift	$V_{CC} = \pm 5\text{ V}$ or $\pm 15\text{ V}$		$T_A = \text{full range}$		10		$\mu\text{V}/^\circ\text{C}$
I_{IB}	Input bias current	$V_{CC} = \pm 5\text{ V}$ or $\pm 15\text{ V}$		$T_A = 25^\circ\text{C}$		2.5	6	μA
				$T_A = \text{full range}$			8	
I_{OS}	Input offset current	$V_{CC} = \pm 5\text{ V}$ or $\pm 15\text{ V}$		$T_A = 25^\circ\text{C}$		35	250	nA
				$T_A = \text{full range}$			400	
	Offset current drift	$T_A = \text{full range}$				0.3		$\text{nA}/^\circ\text{C}$

† Full range = 0°C to 70°C for C suffix and -40°C to 85°C for I suffix

input characteristics

PARAMETER		TEST CONDITIONS†			MIN	TYP	MAX	UNIT
V_{ICR}	Common-mode input voltage range	$V_{CC} = \pm 15\text{ V}$			± 13.8	± 14.3		V
		$V_{CC} = \pm 5\text{ V}$			± 3.8	± 4.3		
CMRR	Common mode rejection ratio	$V_{CC} = \pm 15\text{ V}$,	$V_{ICR} = \pm 12\text{ V}$	$T_A = \text{full range}$	70	90		dB
		$V_{CC} = \pm 5\text{ V}$,	$V_{ICR} = \pm 2.5\text{ V}$		80	100		
r_i	Input resistance					1		$\text{M}\Omega$
C_i	Input capacitance					1.5		pF

† Full range = 0°C to 70°C for C suffix and -40°C to 85°C for I suffix



THS4041, THS4042

165-MHz C-STABLE HIGH-SPEED AMPLIFIERS

SLOS237B–MAY 1999 – REVISED FEBRUARY 2000

electrical characteristics at $T_A = 25^\circ\text{C}$, $V_{CC} = \pm 15\text{ V}$, $R_L = 150\ \Omega$ (unless otherwise noted) (continued)

output characteristics

PARAMETER		TEST CONDITION [†]		MIN	TYP	MAX	UNIT
V_O	Output voltage swing	$V_{CC} = \pm 15\text{ V}$	$R_L = 250\ \Omega$	± 11.5	± 13		V
		$V_{CC} = \pm 5\text{ V}$	$R_L = 150\ \Omega$	± 3.2	± 3.5		
		$V_{CC} = \pm 15\text{ V}$	$R_L = 1\text{ k}\Omega$	± 13	± 13.6		V
		$V_{CC} = \pm 5\text{ V}$		± 3.5	± 3.8		
I_O	Output current [‡]	$V_{CC} = \pm 15\text{ V}$	$R_L = 20\ \Omega$	80	100		mA
		$V_{CC} = \pm 5\text{ V}$		50	65		
I_{SC}	Short-circuit current [‡]	$V_{CC} = \pm 15\text{ V}$			150		mA
R_O	Output resistance	Open loop			13		Ω

[†] Full range = 0°C to 70°C for C suffix and -40°C to 85°C for I suffix

[‡] Observe power dissipation ratings to keep the junction temperature below the absolute maximum rating when the output is heavily loaded or shorted. See the absolute maximum ratings section of this data sheet for more information.

power supply

PARAMETER		TEST CONDITION [†]		MIN	TYP	MAX	UNIT
V_{CC}	Supply voltage operating range	Dual supply		± 4.5		± 16.5	V
		Single supply		9		33	
I_{CC}	Supply current (per amplifier)	$V_{CC} = \pm 15\text{ V}$	$T_A = 25^\circ\text{C}$	8	9.5		mA
			$T_A = \text{full range}$			11	
		$V_{CC} = \pm 5\text{ V}$	$T_A = 25^\circ\text{C}$	7	8.5		
			$T_A = \text{full range}$			10	
PSRR	Power supply rejection ratio	$V_{CC} = \pm 5\text{ V}$ or $\pm 15\text{ V}$		$T_A = 25^\circ\text{C}$	75	84	dB
				$T_A = \text{full range}$	70		

[†] Full range = 0°C to 70°C for C suffix and -40°C to 85°C for I suffix



THS4041, THS4042 165-MHz C-STABLE HIGH-SPEED AMPLIFIERS

SLOS237B—MAY 1999—REVISED FEBRUARY 2000

TYPICAL CHARACTERISTICS

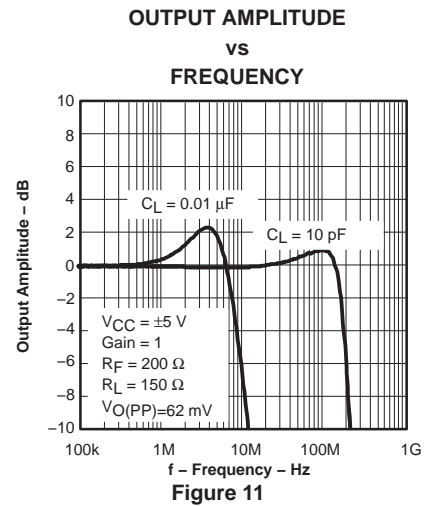
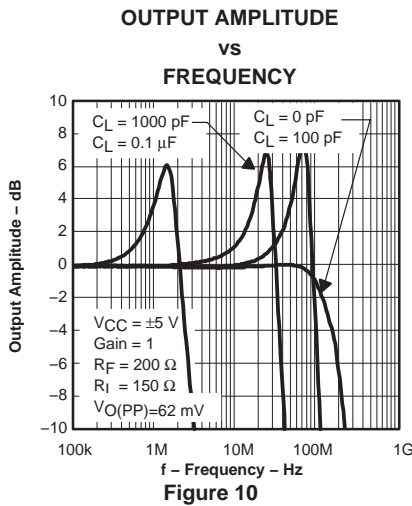
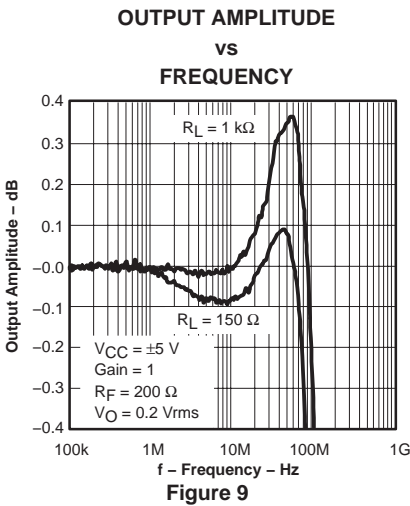
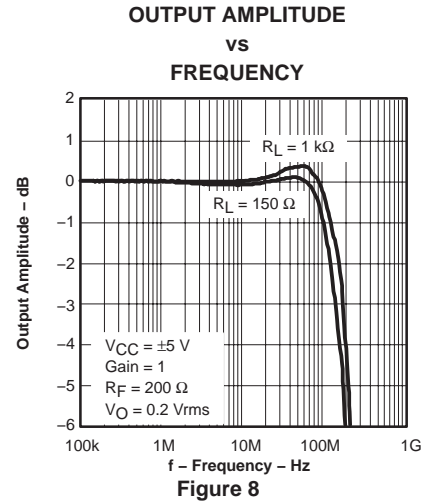
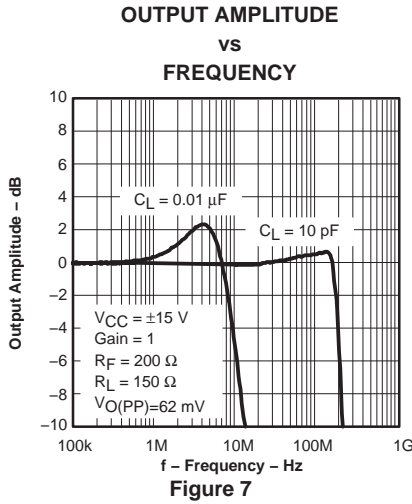
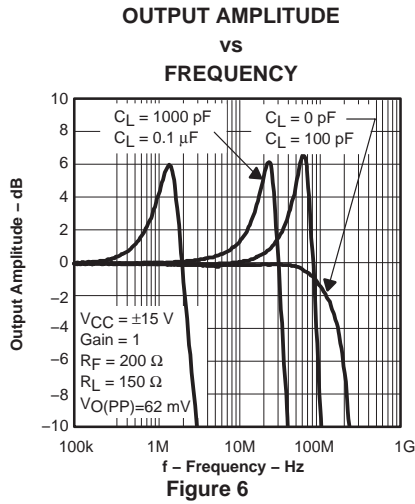
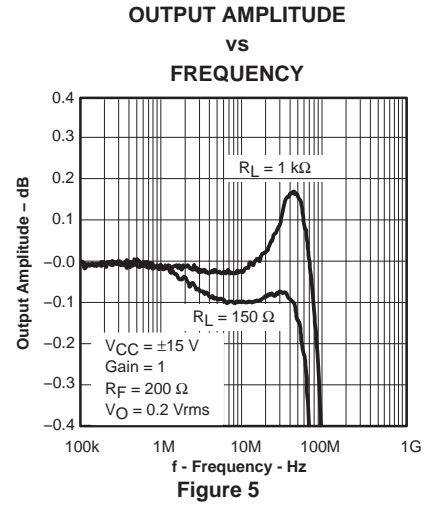
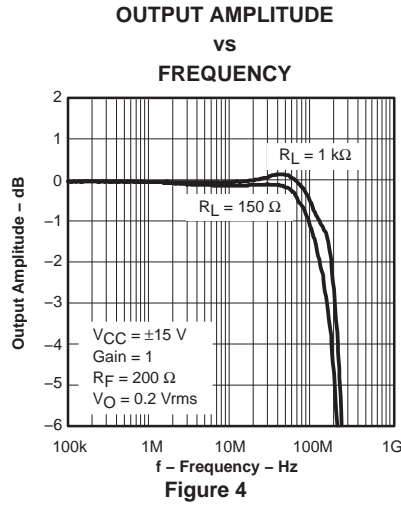
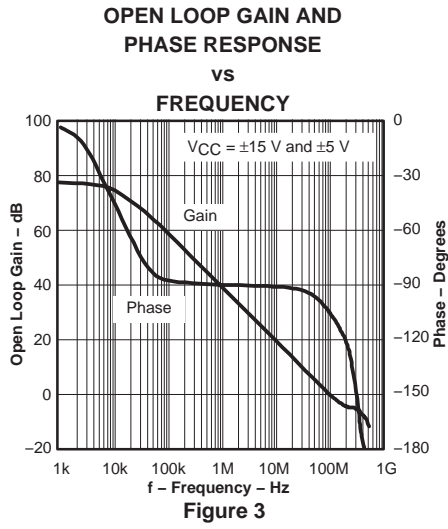

TYPICAL CHARACTERISTICS

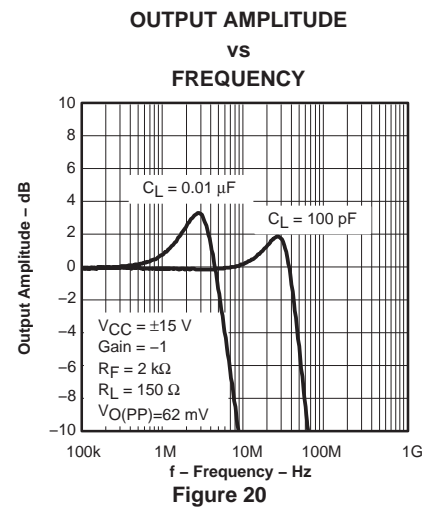
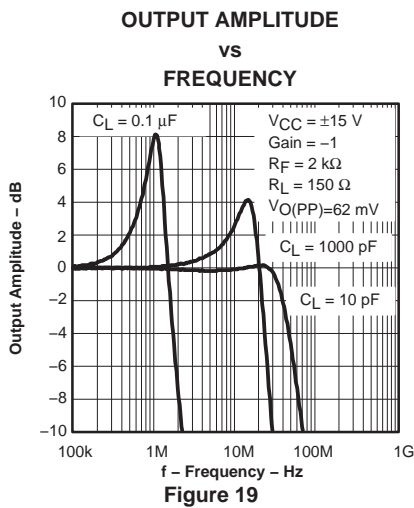
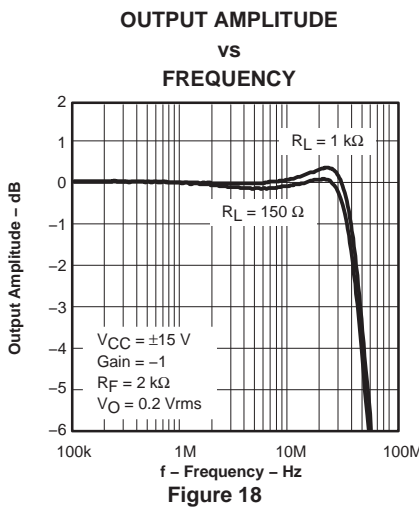
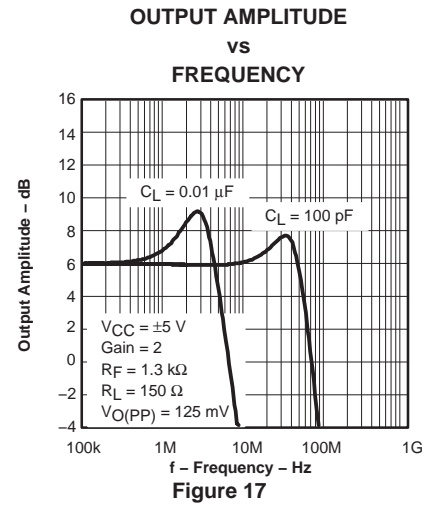
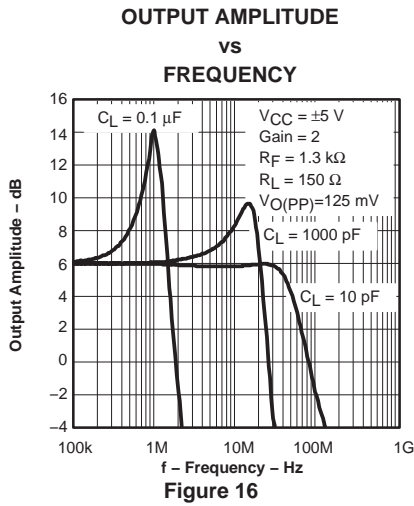
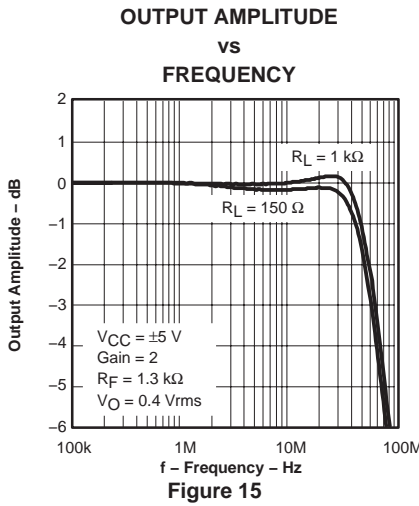
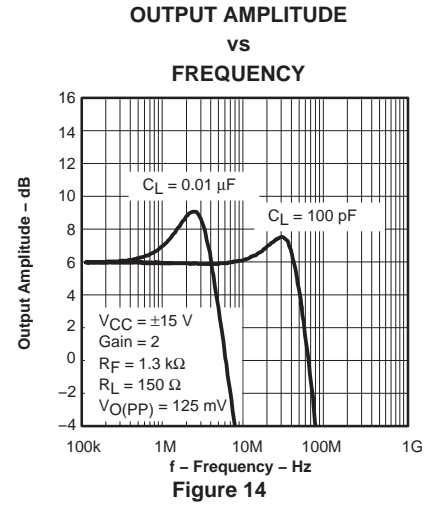
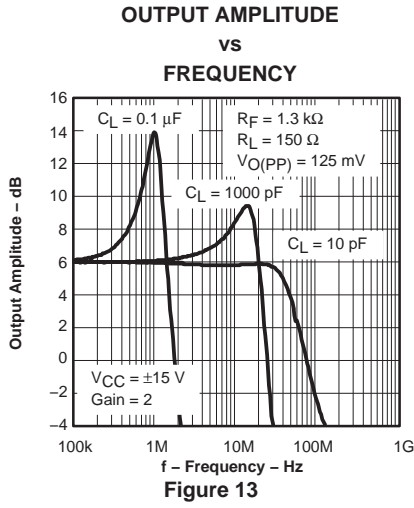
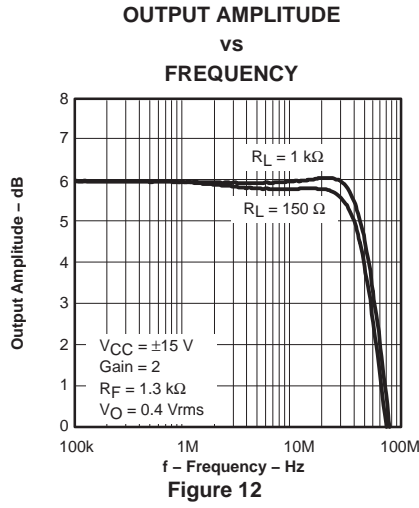

THS4041, THS4042 165-MHz C-STABLE HIGH-SPEED AMPLIFIERS

SLOS237B–MAY 1999 – REVISED FEBRUARY 2000

TYPICAL CHARACTERISTICS

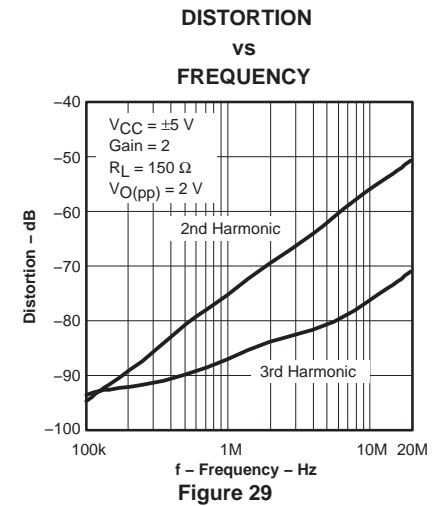
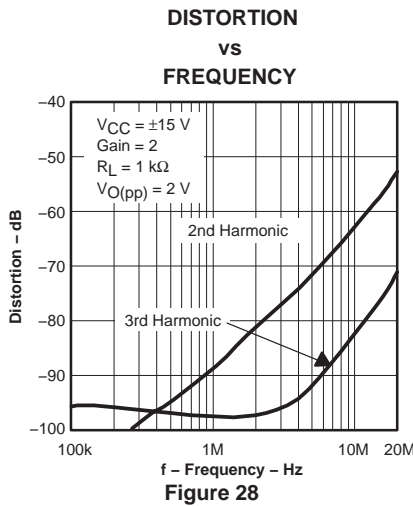
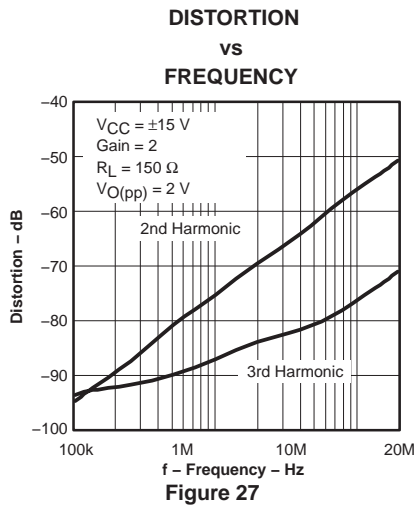
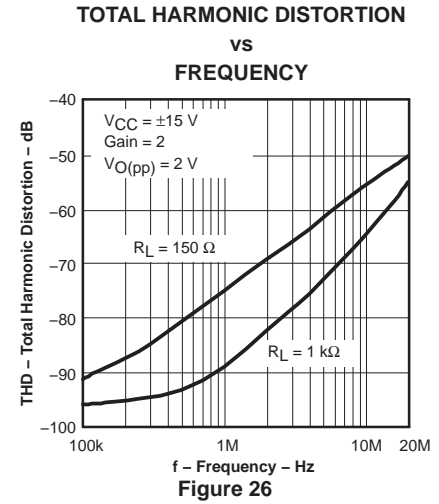
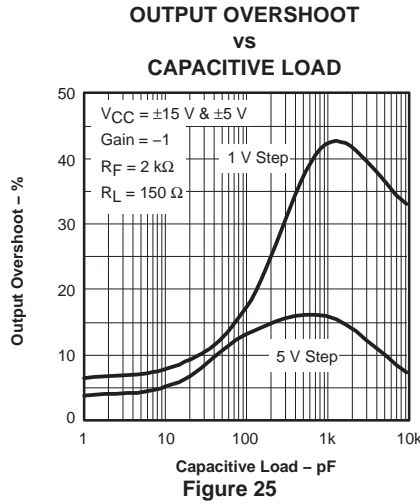
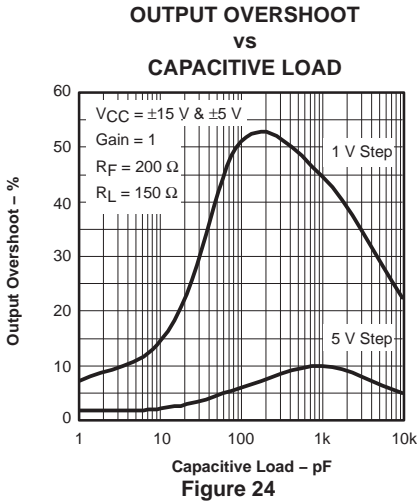
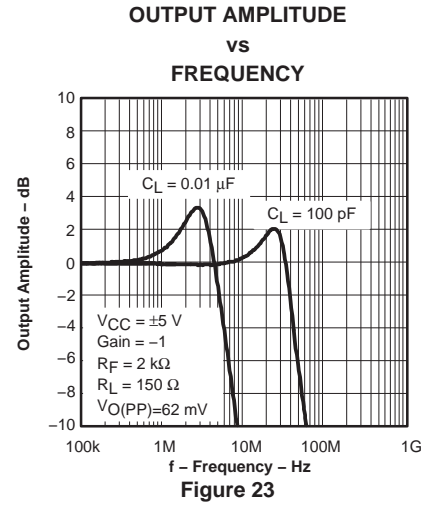
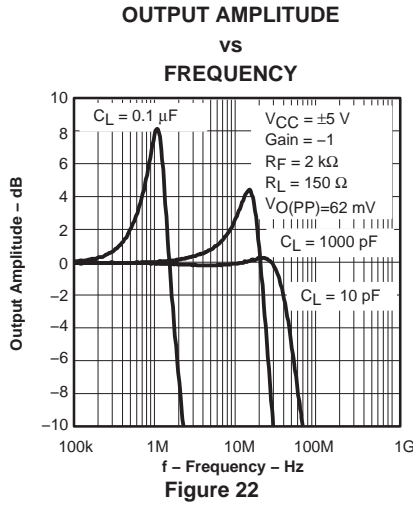
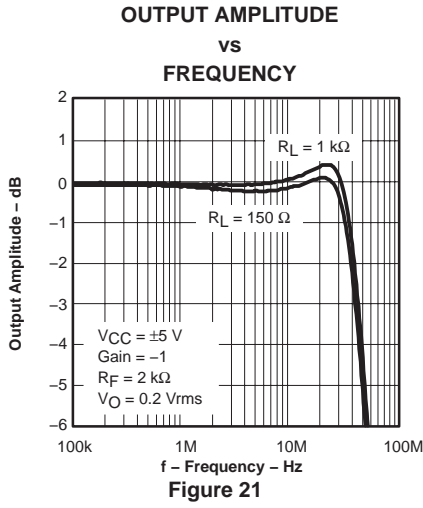

TYPICAL CHARACTERISTICS

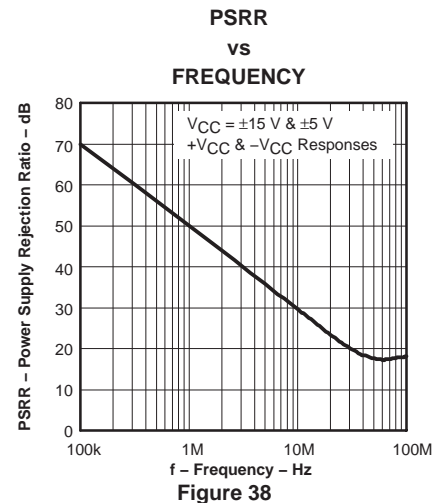
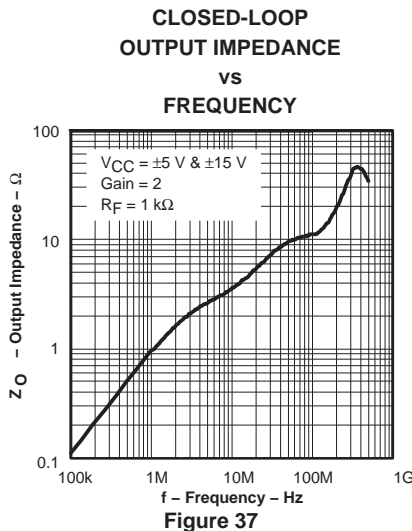
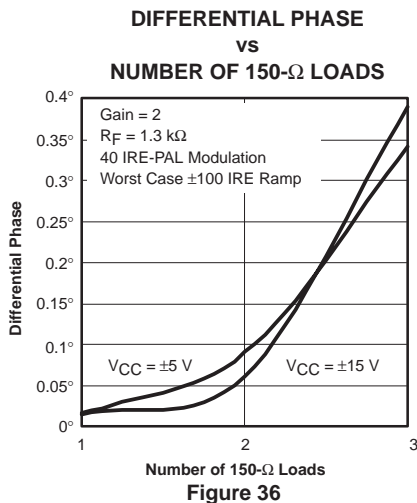
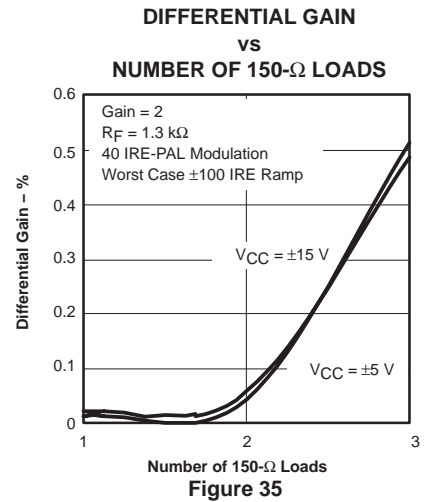
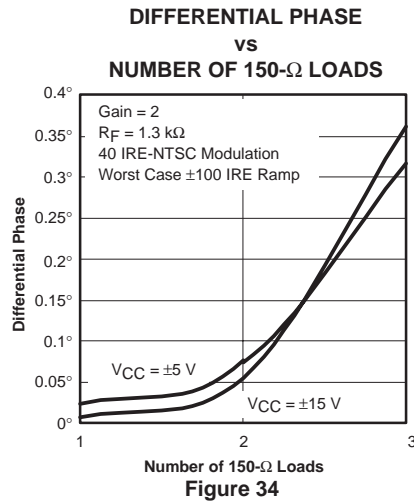
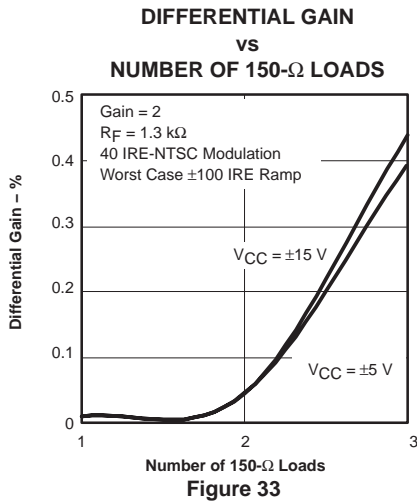
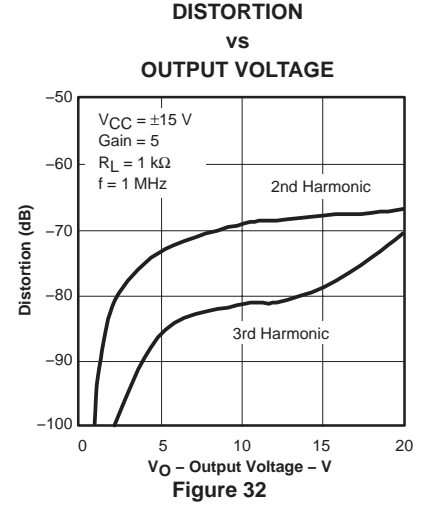
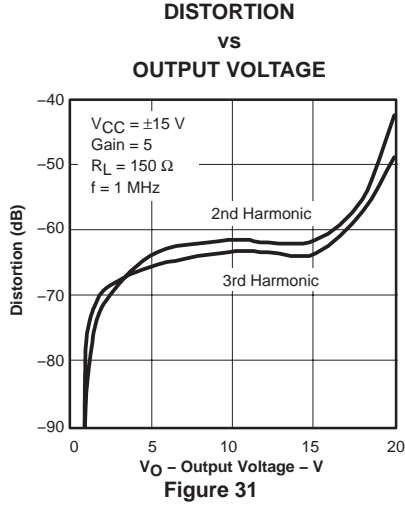
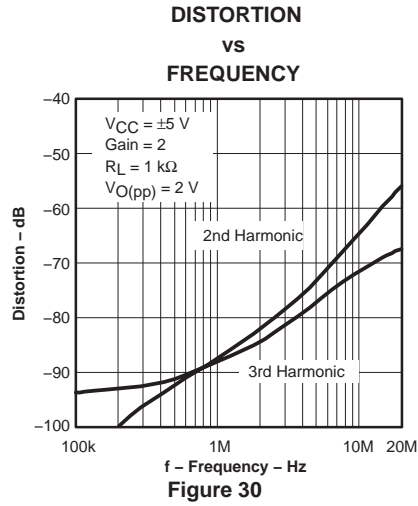

THS4041, THS4042 165-MHz C-STABLE HIGH-SPEED AMPLIFIERS

SLOS237B—MAY 1999—REVISED FEBRUARY 2000

TYPICAL CHARACTERISTICS

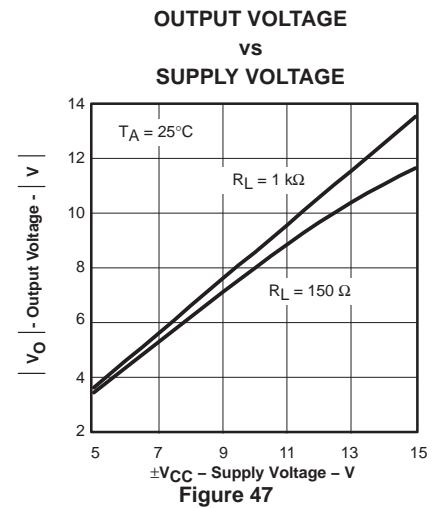
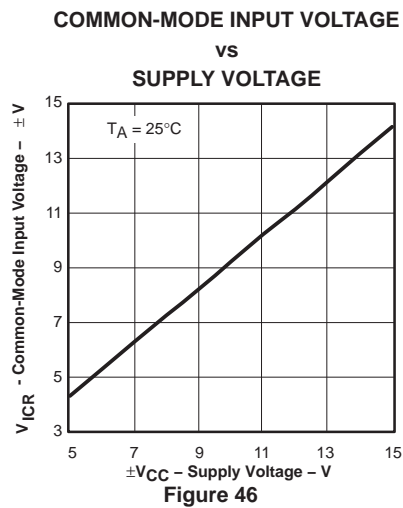
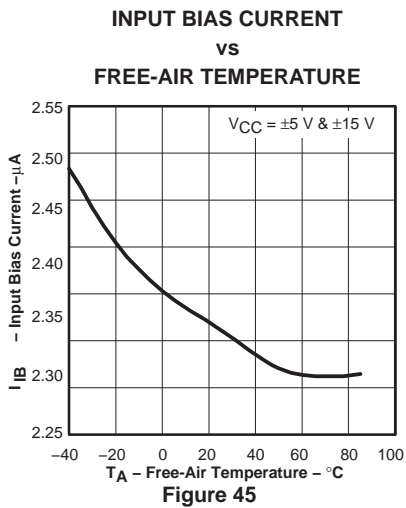
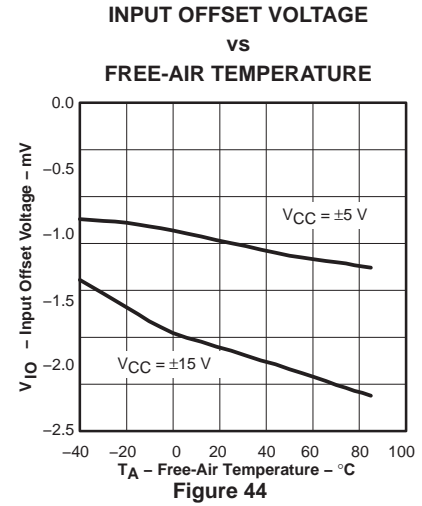
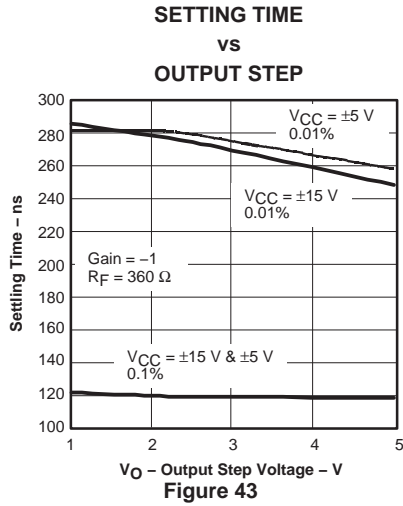
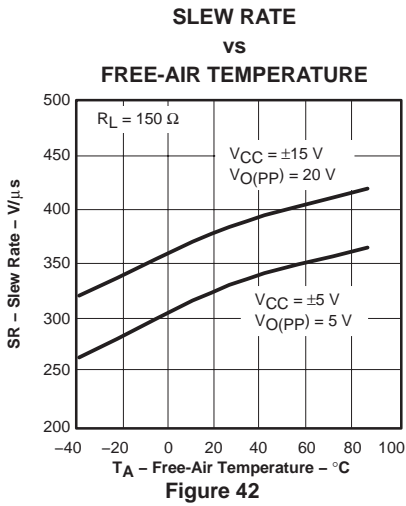
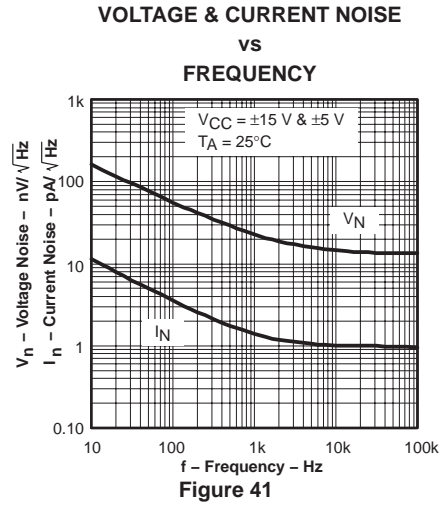
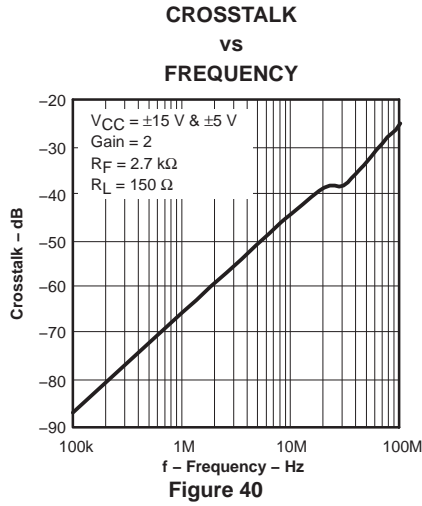
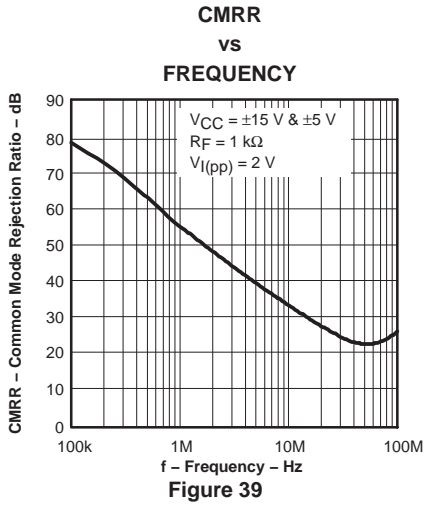

TYPICAL CHARACTERISTICS

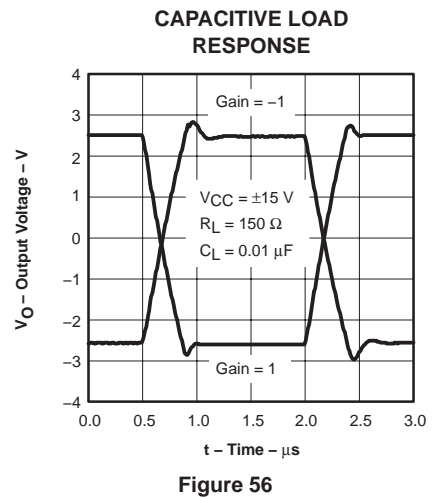
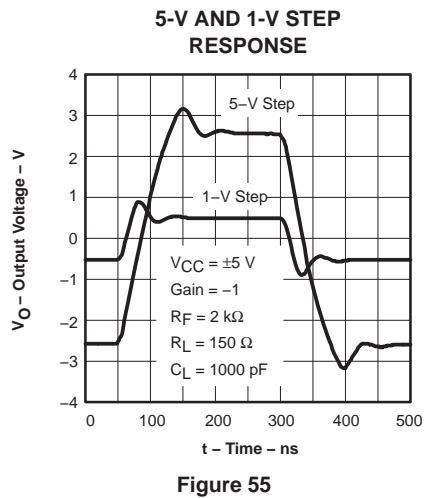
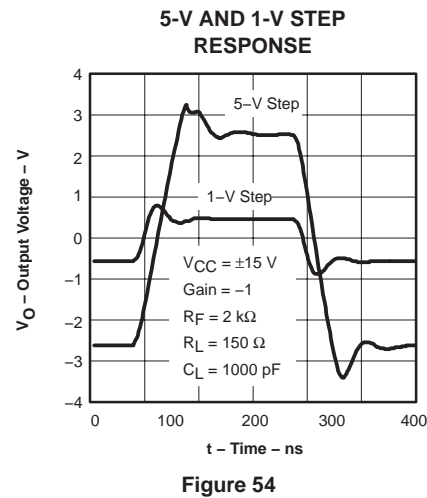
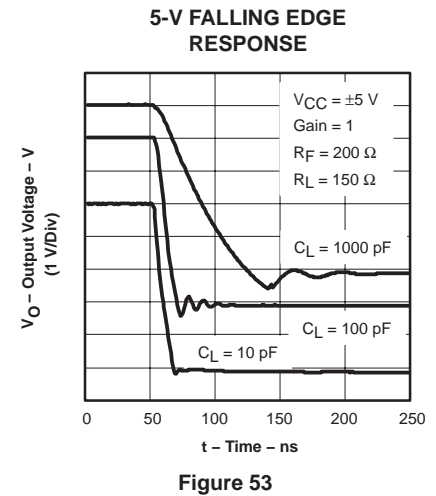
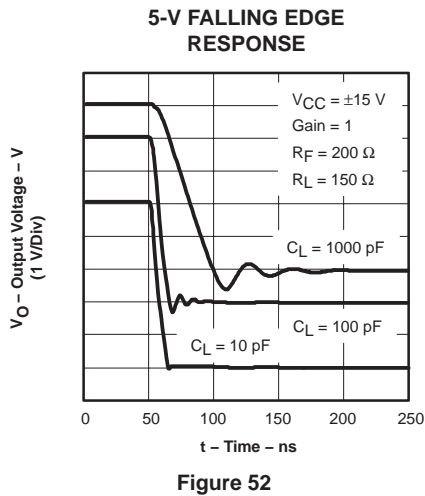
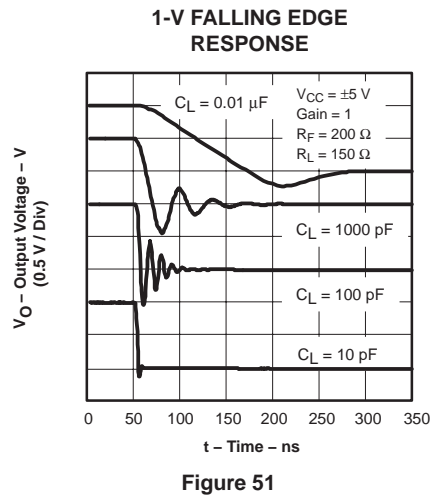
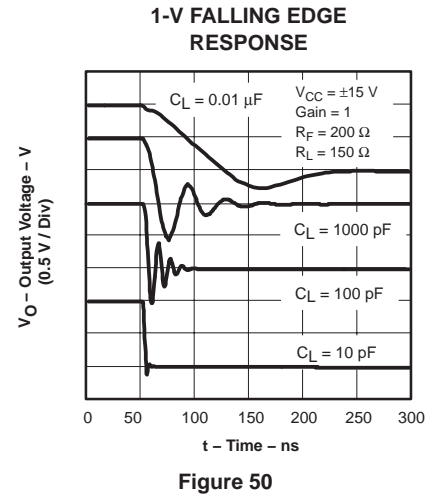
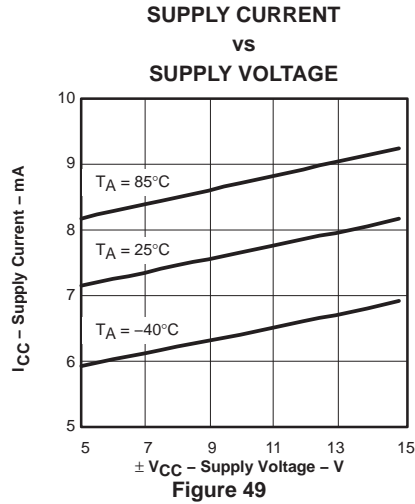
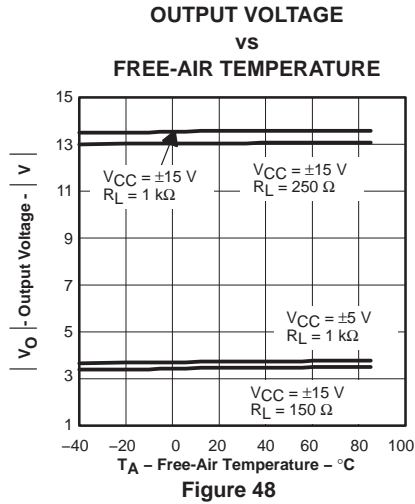

THS4041, THS4042 165-MHz C-STABLE HIGH-SPEED AMPLIFIERS

SLOS237B–MAY 1999 – REVISED FEBRUARY 2000

TYPICAL CHARACTERISTICS

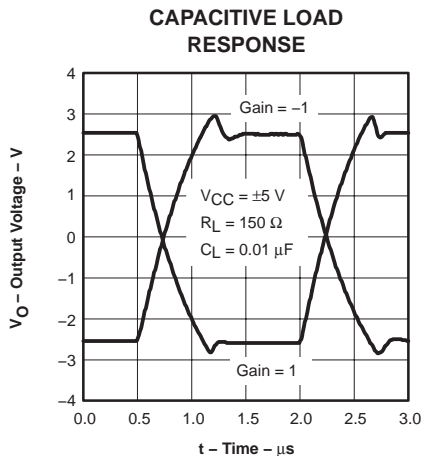

Figure 57

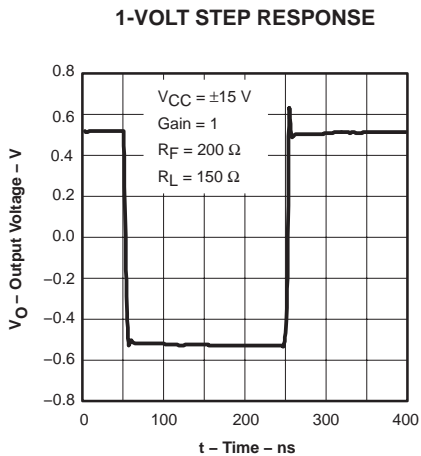

Figure 58

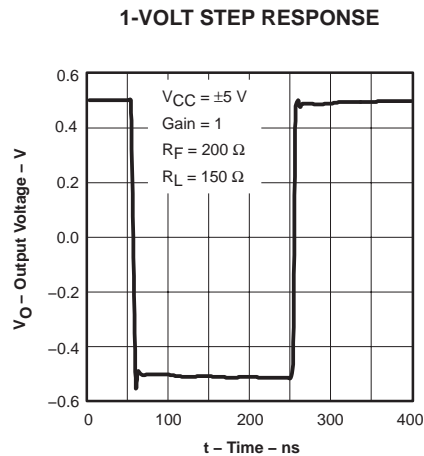

Figure 59

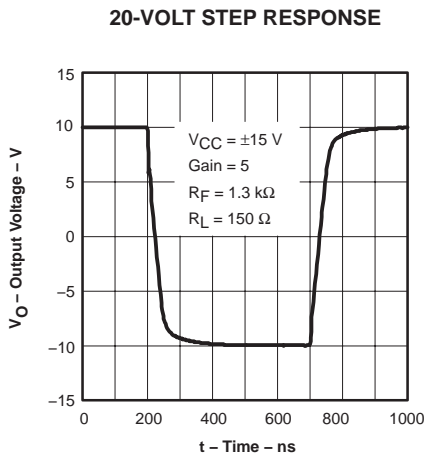

Figure 60

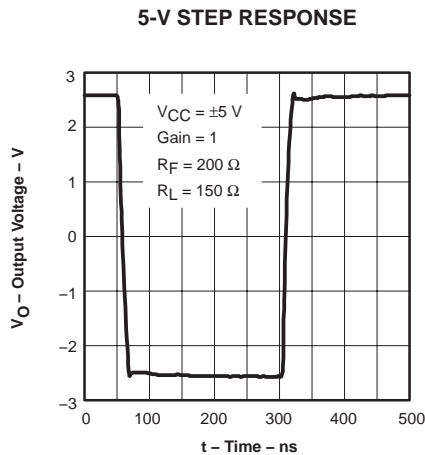

Figure 61

APPLICATION INFORMATION

theory of operation

The THS404x is a high-speed, operational amplifier configured in a voltage feedback architecture. It is built using a 30-V, dielectrically isolated, complementary bipolar process with NPN and PNP transistors possessing f_T s of several GHz. This results in an exceptionally high performance amplifier that has a wide bandwidth, high slew rate, fast settling time, and low distortion. A simplified schematic is shown in Figure 62.

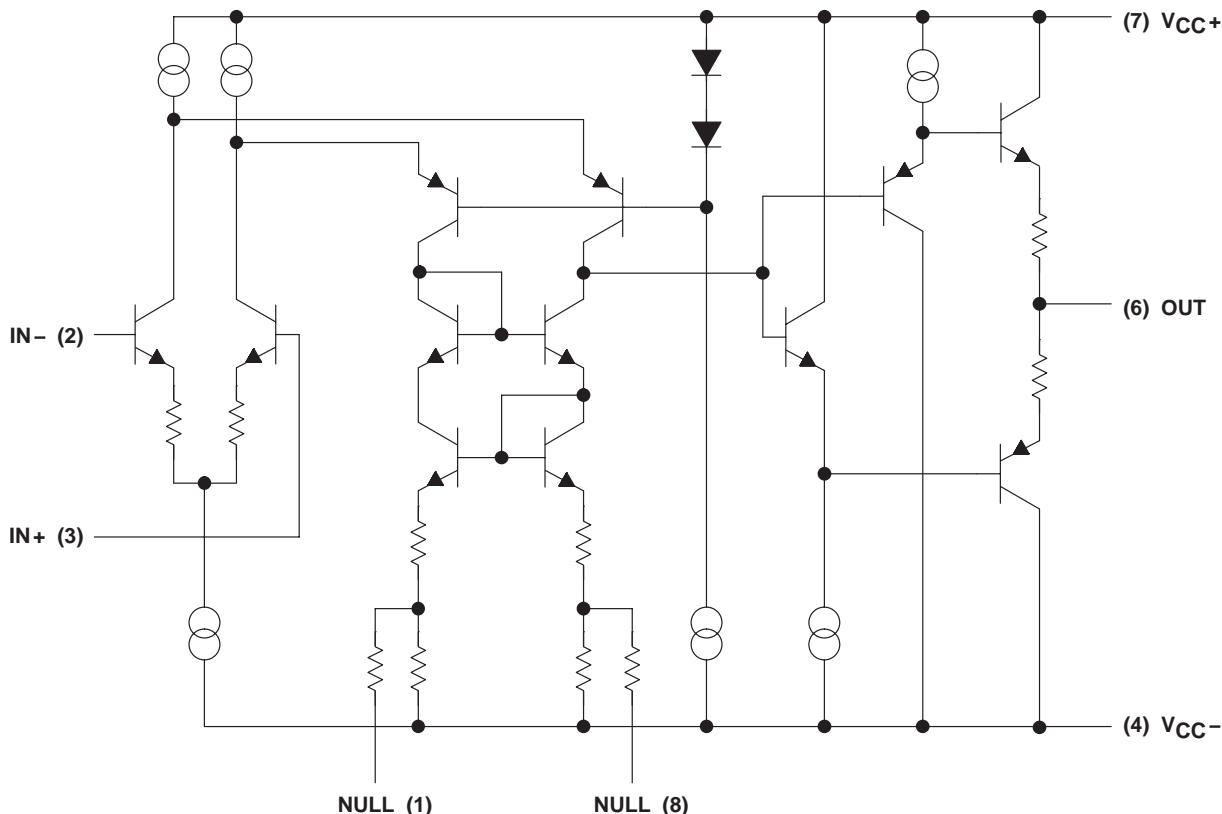

Figure 62. THS4041 Simplified Schematic

noise calculations and noise figure

Noise can cause errors on very small signals. This is especially true when amplifying small signals, where signal-to-noise ratio (SNR) is very important. The noise model for the THS404x is shown in Figure 63. This model includes all of the noise sources as follows:

- e_n = Amplifier internal voltage noise (nV/\sqrt{Hz})
- $IN+$ = Noninverting current noise (pA/\sqrt{Hz})
- $IN-$ = Inverting current noise (pA/\sqrt{Hz})
- e_{RX} = Thermal voltage noise associated with each resistor ($e_{RX} = 4 kTR_X$)

APPLICATION INFORMATION

noise calculations and noise figure (continued)

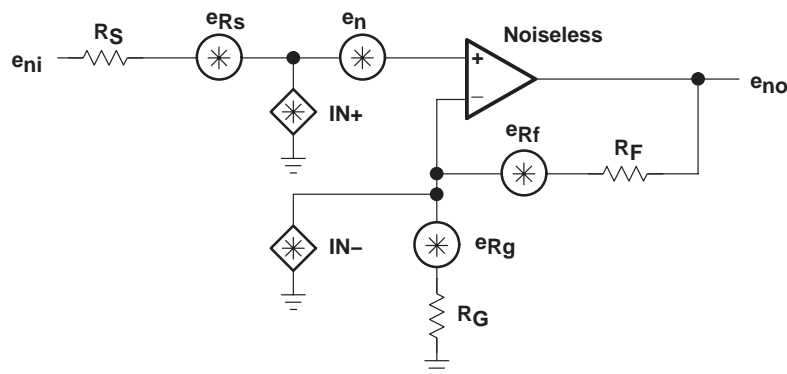

Figure 63. Noise Model

The total equivalent input noise density (e_{ni}) is calculated by using the following equation:

$$e_{ni} = \sqrt{(e_n)^2 + (IN+ \times R_S)^2 + (IN- \times (R_F \parallel R_G))^2 + 4 kTR_S + 4 kT(R_F \parallel R_G)}$$

Where:

- k = Boltzmann's constant = 1.380658×10^{-23}
- T = Temperature in degrees Kelvin (273 + °C)
- $R_F \parallel R_G$ = Parallel resistance of R_F and R_G

To get the equivalent output noise of the amplifier, just multiply the equivalent input noise density (e_{ni}) by the overall amplifier gain (A_V).

$$e_{no} = e_{ni} A_V = e_{ni} \left(1 + \frac{R_F}{R_G} \right) \text{ (noninverting case)}$$

As the previous equations show, to keep noise at a minimum, small value resistors should be used. As the closed-loop gain is increased (by reducing R_G), the input noise is reduced considerably because of the parallel resistance term. This leads to the general conclusion that the most dominant noise sources are the source resistor (R_S) and the internal amplifier noise voltage (e_n). Because noise is summed in a root-mean-squares method, noise sources smaller than 25% of the largest noise source can be effectively ignored. This can greatly simplify the formula and make noise calculations much easier to calculate.

For more information on noise analysis, please refer to the *Noise Analysis* section in *Operational Amplifier Circuits Applications Report* (literature number SLVA043).

APPLICATION INFORMATION

noise calculations and noise figure (continued)

This brings up another noise measurement usually preferred in RF applications, the noise figure (NF). Noise figure is a measure of noise degradation caused by the amplifier. The value of the source resistance must be defined and is typically 50 Ω in RF applications.

$$NF = 10\log \left[\frac{e_{ni}^2}{(e_{Rs})^2} \right]$$

Because the dominant noise components are generally the source resistance and the internal amplifier noise voltage, we can approximate noise figure as:

$$NF = 10\log \left[1 + \frac{\left[(e_n)^2 + (IN + \times R_S)^2 \right]}{4 kTR_S} \right]$$

Figure 64 shows the noise figure graph for the THS404x.

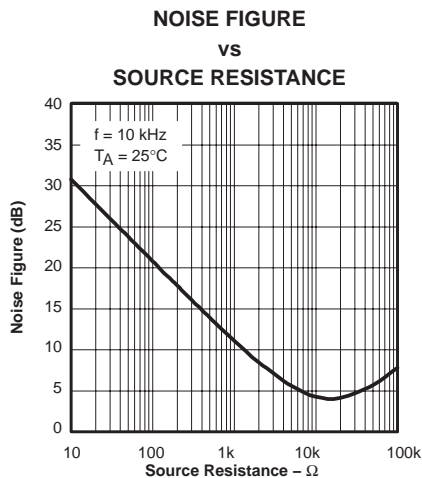

Figure 64. Noise Figure vs Source Resistance

THS4041, THS4042 165-MHz C-STABLE HIGH-SPEED AMPLIFIERS

SLOS237B–MAY 1999 – REVISED FEBRUARY 2000

APPLICATION INFORMATION

driving a capacitive load

Driving capacitive loads with high performance amplifiers is not a problem as long as certain precautions are taken. The first is to realize that the THS404x has been internally compensated to maximize its bandwidth and slew rate performance. Typically when the amplifier is compensated in this manner, capacitive loading directly on the output will decrease the device's phase margin, leading to high frequency ringing or oscillations. However, the THS404x has added internal circuitry that senses a capacitive load and adds extra compensation to the internal dominant pole. As the capacitive load increases, the amplifier remains stable. But, it is not uncommon to see a small amount of peaking in the frequency response. There are typically two ways to compensate for this. The first is to simply increase the gain of the amplifier. This helps by increasing the phase margin to keep peaking minimized. The second is to place an isolation resistor in series with the output of the amplifier, as shown in Figure 65. A minimum value of $20\ \Omega$ should work well for most applications. For example, in $75\text{-}\Omega$ transmission systems, setting the series resistor value to $75\ \Omega$ both isolates any capacitance loading and provides the proper line impedance matching at the source end. For more information about driving capacitive loads, refer to the *Output Resistance and Capacitance* section of the *Parasitic Capacitance in Op Amp Circuits Application Report* (literature number: SLOA013).

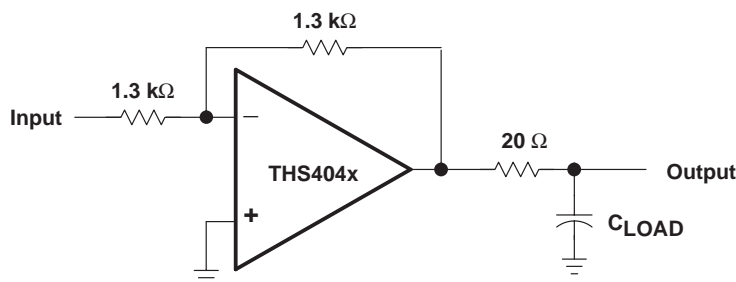

Figure 65. Driving a Capacitive Load for Extra Stability

offset nulling

The THS404x has very low input offset voltage for a high-speed amplifier. However, if additional correction is required, an offset nulling function has been provided on the THS4041. The input offset can be adjusted by placing a potentiometer between terminals 1 and 8 of the device and tying the wiper to the negative supply. This is shown in Figure 66.

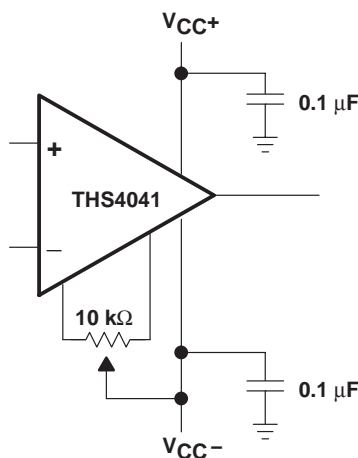

Figure 66. Offset Nulling Schematic



APPLICATION INFORMATION

offset voltage

The output offset voltage, (V_{OO}) is the sum of the input offset voltage (V_{IO}) and both input bias currents (I_{IB}) times the corresponding gains. The following schematic and formula can be used to calculate the output offset voltage:

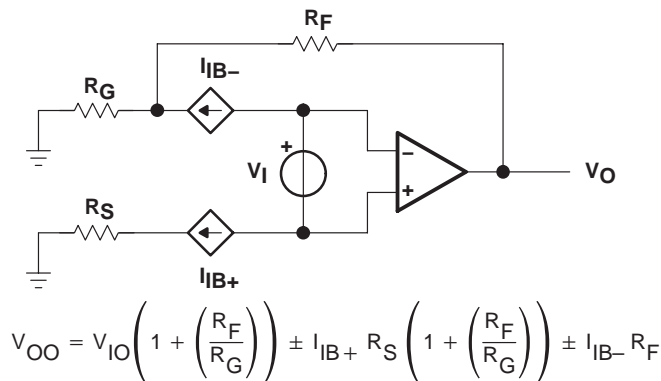

Figure 67. Output Offset Voltage Model

optimizing unity gain response

Internal frequency compensation of the THS404x was selected to provide very wideband performance yet still maintain stability when operated in a noninverting unity gain configuration. When amplifiers are compensated in this manner there is usually peaking in the closed loop response and some ringing in the step response for very fast input edges, depending upon the application. This is because a minimum phase margin is maintained for the $G=+1$ configuration. For optimum settling time and minimum ringing, a feedback resistor of 200Ω should be used as shown in Figure 68. Additional capacitance can also be used in parallel with the feedback resistance if even finer optimization is required.

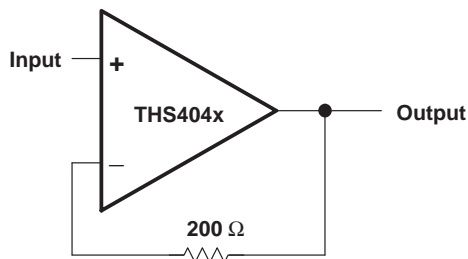

Figure 68. Noninverting, Unity Gain Schematic

THS4041, THS4042

165-MHz C-STABLE HIGH-SPEED AMPLIFIERS

SLOS237B– MAY 1999 – REVISED FEBRUARY 2000

APPLICATION INFORMATION

circuit layout considerations

To achieve the levels of high frequency performance of the THS404x, follow proper printed-circuit board high frequency design techniques. A general set of guidelines is given below. In addition, a THS404x evaluation board is available to use as a guide for layout or for evaluating the device performance.

- Ground planes – It is highly recommended that a ground plane be used on the board to provide all components with a low inductive ground connection. However, in the areas of the amplifier inputs and output, the ground plane can be removed to minimize the stray capacitance.
- Proper power supply decoupling – Use a 6.8- μ F tantalum capacitor in parallel with a 0.1- μ F ceramic capacitor on each supply terminal. It may be possible to share the tantalum among several amplifiers depending on the application, but a 0.1- μ F ceramic capacitor should always be used on the supply terminal of every amplifier. In addition, the 0.1- μ F capacitor should be placed as close as possible to the supply terminal. As this distance increases, the inductance in the connecting trace makes the capacitor less effective. The designer should strive for distances of less than 0.1 inches between the device power terminals and the ceramic capacitors.
- Sockets – Sockets are not recommended for high-speed operational amplifiers. The additional lead inductance in the socket pins will often lead to stability problems. Surface-mount packages soldered directly to the printed-circuit board is the best implementation.
- Short trace runs/compact part placements – Optimum high frequency performance is achieved when stray series inductance has been minimized. To realize this, the circuit layout should be made as compact as possible, thereby minimizing the length of all trace runs. Particular attention should be paid to the inverting input of the amplifier. Its length should be kept as short as possible. This will help to minimize stray capacitance at the input of the amplifier.
- Surface-mount passive components – Using surface-mount passive components is recommended for high frequency amplifier circuits for several reasons. First, because of the extremely low lead inductance of surface-mount components, the problem with stray series inductance is greatly reduced. Second, the small size of surface-mount components naturally leads to a more compact layout, thereby minimizing both stray inductance and capacitance. If leaded components are used, it is recommended that the lead lengths be kept as short as possible.

general PowerPAD design considerations

The THS404x is available packaged in a thermally-enhanced DGN package, which is a member of the PowerPAD family of packages. This package is constructed using a downset leadframe upon which the die is mounted [see Figure 69(a) and Figure 69(b)]. This arrangement results in the lead frame being exposed as a thermal pad on the underside of the package [see Figure 69(c)]. Because this thermal pad has direct thermal contact with the die, excellent thermal performance can be achieved by providing a good thermal path away from the thermal pad.

The PowerPAD package allows for both assembly and thermal management in one manufacturing operation. During the surface-mount solder operation (when the leads are being soldered), the thermal pad can also be soldered to a copper area underneath the package. Through the use of thermal paths within this copper area, heat can be conducted away from the package into either a ground plane or other heat dissipating device.

The PowerPAD package represents a breakthrough in combining the small area and ease of assembly of the surface mount with the, heretofore, awkward mechanical methods of heatsinking.



POST OFFICE BOX 655303 • DALLAS, TEXAS 75265

APPLICATION INFORMATION

general PowerPAD design considerations (continued)

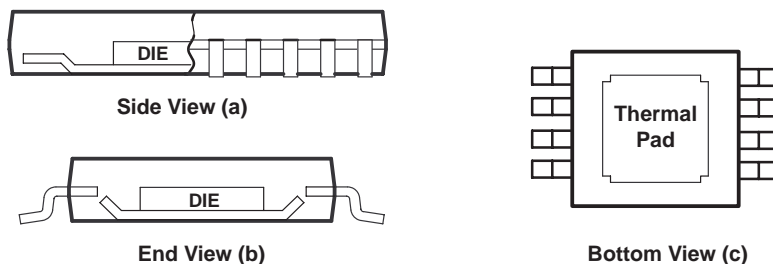

NOTE A: The thermal pad is electrically isolated from all terminals in the package.

Figure 69. Views of Thermally Enhanced DGN Package

Although there are many ways to properly heatsink this device, the following steps illustrate the recommended approach.

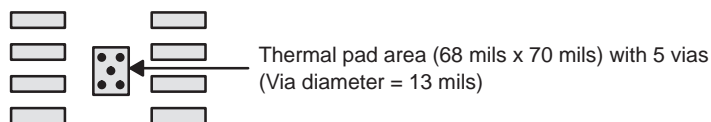

Figure 70. PowerPAD PCB Etch and Via Pattern

1. Prepare the PCB with a top side etch pattern as shown in Figure 70. There should be etch for the leads as well as etch for the thermal pad.
2. Place five holes in the area of the thermal pad. These holes should be 13 mils in diameter. Keep them small so that solder wicking through the holes is not a problem during reflow.
3. Additional vias may be placed anywhere along the thermal plane outside of the thermal pad area. This helps dissipate the heat generated by the THS404xDGN IC. These additional vias may be larger than the 13-mil diameter vias directly under the thermal pad. They can be larger because they are not in the thermal pad area to be soldered so that wicking is not a problem.
4. Connect all holes to the internal ground plane.
5. When connecting these holes to the ground plane, **do not** use the typical web or spoke via connection methodology. Web connections have a high thermal resistance connection that is useful for slowing the heat transfer during soldering operations. This makes the soldering of vias that have plane connections easier. In this application, however, low thermal resistance is desired for the most efficient heat transfer. Therefore, the holes under the THS404xDGN package should make their connection to the internal ground plane with a complete connection around the entire circumference of the plated-through hole.
6. The top-side solder mask should leave the terminals of the package and the thermal pad area with its five holes exposed. The bottom-side solder mask should cover the five holes of the thermal pad area. This prevents solder from being pulled away from the thermal pad area during the reflow process.
7. Apply solder paste to the exposed thermal pad area and all of the IC terminals.
8. With these preparatory steps in place, the THS404xDGN IC is simply placed in position and run through the solder reflow operation as any standard surface-mount component. This results in a part that is properly installed.

THS4041, THS4042 165-MHz C-STABLE HIGH-SPEED AMPLIFIERS

SLOS237B– MAY 1999 – REVISED FEBRUARY 2000

APPLICATION INFORMATION

general PowerPAD design considerations (continued)

The actual thermal performance achieved with the THS404xDGN in its PowerPAD package depends on the application. In the example above, if the size of the internal ground plane is approximately 3 inches × 3 inches, then the expected thermal coefficient, θ_{JA} , is about 58.4°C/W. For comparison, the non-PowerPAD version of the THS404x IC (SOIC) is shown. For a given θ_{JA} , the maximum power dissipation is shown in Figure 71 and is calculated by the following formula:

$$P_D = \left(\frac{T_{MAX} - T_A}{\theta_{JA}} \right)$$

Where:

- P_D = Maximum power dissipation of THS404x IC (watts)
- T_{MAX} = Absolute maximum junction temperature (150°C)
- T_A = Free-ambient air temperature (°C)
- θ_{JA} = $\theta_{JC} + \theta_{CA}$
- θ_{JC} = Thermal coefficient from junction to case (°C/W)
- θ_{CA} = Thermal coefficient from case to ambient air (°C/W)

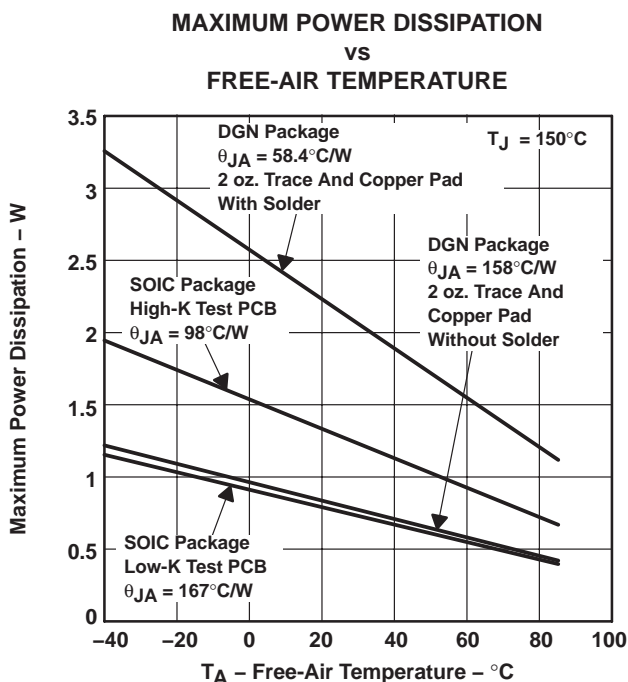

NOTE A: Results are with no air flow and PCB size = 3"× 3"

Figure 71. Maximum Power Dissipation vs Free-Air Temperature

More complete details of the PowerPAD installation process and thermal management techniques can be found in the Texas Instruments Technical Brief, *PowerPAD Thermally Enhanced Package*. This document can be found at the TI web site (www.ti.com) by searching on the key word PowerPAD. The document can also be ordered through your local TI sales office. Refer to literature number SLMA002 when ordering.

APPLICATION INFORMATION

general PowerPAD design considerations (continued)

The next consideration is the package constraints. The two sources of heat within an amplifier are quiescent power and output power. The designer should never forget about the quiescent heat generated within the device, especially mutiamplifier devices. Because these devices have linear output stages (Class A-B), most of the heat dissipation is at low output voltages with high output currents. Figure 72 to Figure 75 show this effect, along with the quiescent heat, with an ambient air temperature of 50°C. Obviously, as the ambient temperature increases, the limit lines shown will drop accordingly. The area under each respective limit line is considered the safe operating area. Any condition above this line will exceed the amplifier's limits and failure may result. When using $V_{CC} = \pm 5\text{ V}$, there is generally not a heat problem, even with SOIC packages. But, when using $V_{CC} = \pm 15\text{ V}$, the SOIC package is severely limited in the amount of heat it can dissipate. The other key factor when looking at these graphs is how the devices are mounted on the PCB. The PowerPAD devices are extremely useful for heat dissipation. But, the device should always be soldered to a copper plane to fully use the heat dissipation properties of the PowerPAD. The SOIC package, on the other hand, is highly dependent on how it is mounted on the PCB. As more trace and copper area is placed around the device, θ_{JA} decreases and the heat dissipation capability increases. The currents and voltages shown in these graphs are for the total package. For the dual amplifier package (THS4042), the sum of the RMS output currents and voltages should be used to choose the proper package. The graphs shown assume that both amplifier's outputs are identical.

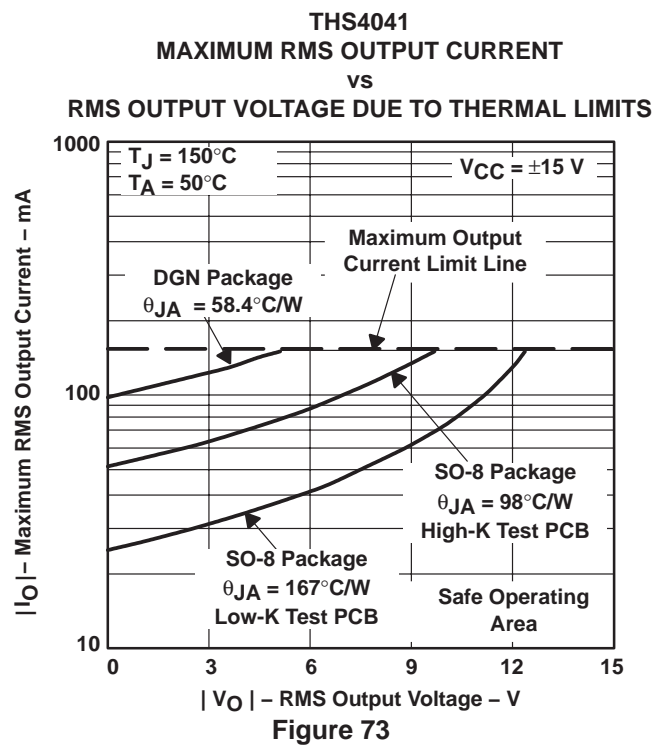
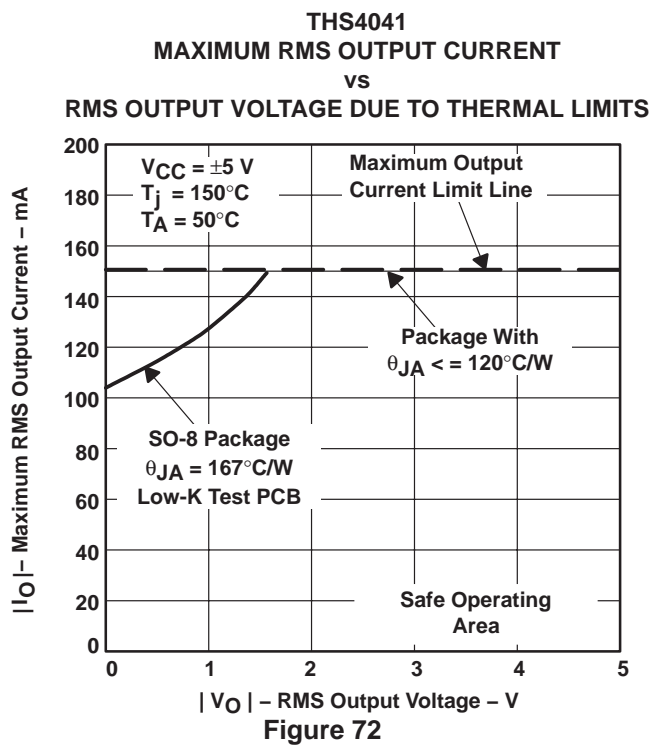

THS4041, THS4042 165-MHz C-STABLE HIGH-SPEED AMPLIFIERS

SLOS237B–MAY 1999 – REVISED FEBRUARY 2000

APPLICATION INFORMATION

general PowerPAD design considerations (continued)

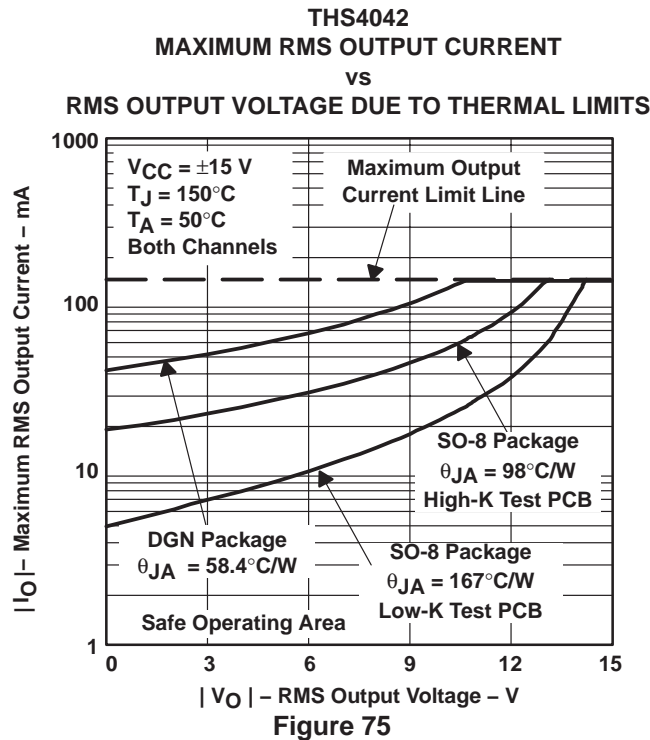
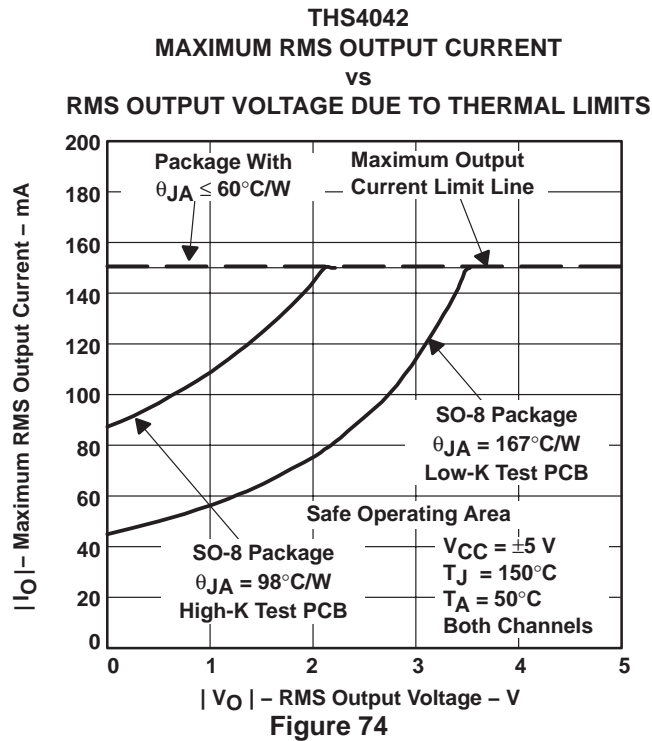

APPLICATION INFORMATION

evaluation board

An evaluation board is available for the THS4041 (literature number SLOP219) and THS4042 (literature number SLOP233). This board has been configured for very low parasitic capacitance in order to realize the full performance of the amplifier. A schematic of the evaluation board is shown in Figure 76. The circuitry has been designed so that the amplifier may be used in either an inverting or noninverting configuration. For more information, please refer to the *THS4041 EVM User's Guide* or the *THS4042 EVM User's Guide*. To order the evaluation board, contact your local TI sales office or distributor.

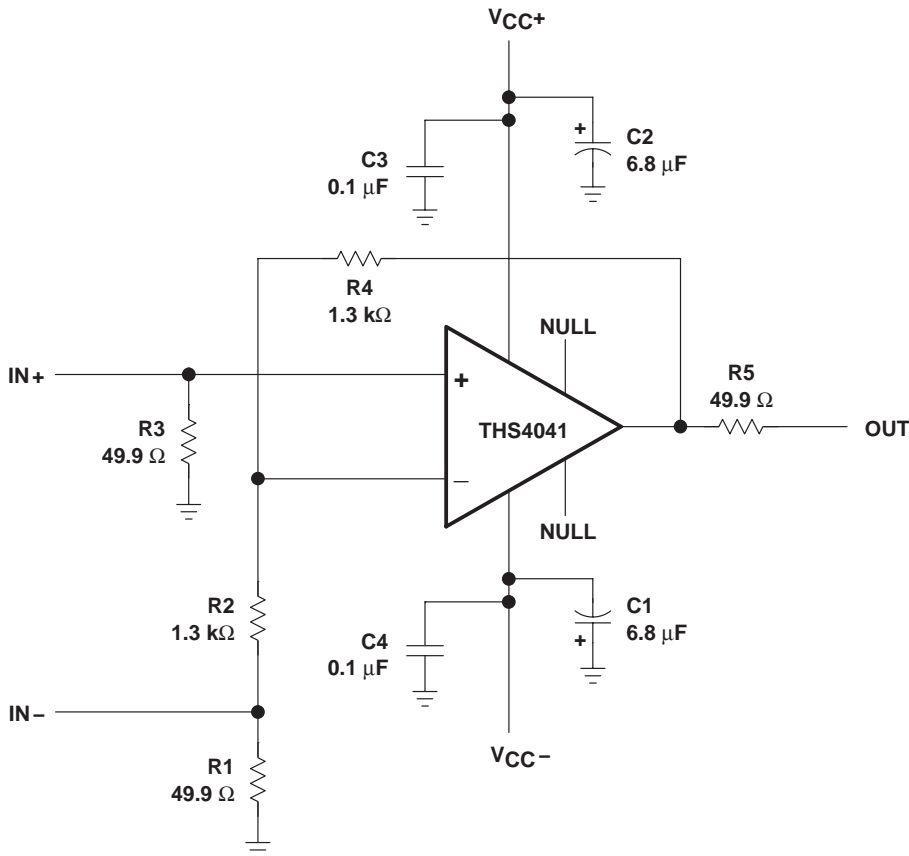

Figure 76. THS4041 Evaluation Board

PACKAGING INFORMATION

Orderable Device	Status ⁽¹⁾	Package Type	Package Drawing	Pins	Package Qty	Eco Plan ⁽²⁾	Lead/Ball Finish	MSL Peak Temp ⁽³⁾
THS4041CD	ACTIVE	SOIC	D	8	75	Green (RoHS & no Sb/Br)	CU NIPDAU	Level-1-260C-UNLIM
THS4041CDG4	ACTIVE	SOIC	D	8	75	Green (RoHS & no Sb/Br)	CU NIPDAU	Level-1-260C-UNLIM
THS4041CDGN	ACTIVE	MSOP-Power PAD	DGN	8	80	Green (RoHS & no Sb/Br)	CU NIPDAU	Level-1-260C-UNLIM
THS4041CDGNG4	ACTIVE	MSOP-Power PAD	DGN	8	80	Green (RoHS & no Sb/Br)	CU NIPDAU	Level-1-260C-UNLIM
THS4041CDGNR	ACTIVE	MSOP-Power PAD	DGN	8	2500	Green (RoHS & no Sb/Br)	CU NIPDAU	Level-1-260C-UNLIM
THS4041CDGNRG4	ACTIVE	MSOP-Power PAD	DGN	8	2500	Green (RoHS & no Sb/Br)	CU NIPDAU	Level-1-260C-UNLIM
THS4041CDR	ACTIVE	SOIC	D	8	2500	Green (RoHS & no Sb/Br)	CU NIPDAU	Level-1-260C-UNLIM
THS4041CDRG4	ACTIVE	SOIC	D	8	2500	Green (RoHS & no Sb/Br)	CU NIPDAU	Level-1-260C-UNLIM
THS4041ID	ACTIVE	SOIC	D	8	75	Green (RoHS & no Sb/Br)	CU NIPDAU	Level-1-260C-UNLIM
THS4041IDG4	ACTIVE	SOIC	D	8	75	Green (RoHS & no Sb/Br)	CU NIPDAU	Level-1-260C-UNLIM
THS4041IDGN	ACTIVE	MSOP-Power PAD	DGN	8	80	Green (RoHS & no Sb/Br)	CU NIPDAU	Level-1-260C-UNLIM
THS4041IDGNG4	ACTIVE	MSOP-Power PAD	DGN	8	80	Green (RoHS & no Sb/Br)	CU NIPDAU	Level-1-260C-UNLIM
THS4041IDGNR	ACTIVE	MSOP-Power PAD	DGN	8	2500	Green (RoHS & no Sb/Br)	CU NIPDAU	Level-1-260C-UNLIM
THS4041IDGNRG4	ACTIVE	MSOP-Power PAD	DGN	8	2500	Green (RoHS & no Sb/Br)	CU NIPDAU	Level-1-260C-UNLIM
THS4041IDR	ACTIVE	SOIC	D	8	2500	Green (RoHS & no Sb/Br)	CU NIPDAU	Level-1-260C-UNLIM
THS4041IDRG4	ACTIVE	SOIC	D	8	2500	Green (RoHS & no Sb/Br)	CU NIPDAU	Level-1-260C-UNLIM
THS4042CD	ACTIVE	SOIC	D	8	75	Green (RoHS & no Sb/Br)	CU NIPDAU	Level-1-260C-UNLIM
THS4042CDG4	ACTIVE	SOIC	D	8	75	Green (RoHS & no Sb/Br)	CU NIPDAU	Level-1-260C-UNLIM
THS4042CDGN	ACTIVE	MSOP-Power PAD	DGN	8	80	Green (RoHS & no Sb/Br)	CU NIPDAU	Level-1-260C-UNLIM
THS4042CDGNG4	ACTIVE	MSOP-Power PAD	DGN	8	80	Green (RoHS & no Sb/Br)	CU NIPDAU	Level-1-260C-UNLIM
THS4042CDGNR	ACTIVE	MSOP-	DGN	8	2500	Green (RoHS & no Sb/Br)	CU NIPDAU	Level-1-260C-UNLIM

Orderable Device	Status ⁽¹⁾	Package Type	Package Drawing	Pins	Package Qty	Eco Plan ⁽²⁾	Lead/Ball Finish	MSL Peak Temp ⁽³⁾
		Power PAD				no Sb/Br)		
THS4042CDGNGR4	ACTIVE	MSOP-Power PAD	DGN	8	2500	Green (RoHS & no Sb/Br)	CU NIPDAU	Level-1-260C-UNLIM
THS4042ID	ACTIVE	SOIC	D	8	75	Green (RoHS & no Sb/Br)	CU NIPDAU	Level-1-260C-UNLIM
THS4042IDG4	ACTIVE	SOIC	D	8	75	Green (RoHS & no Sb/Br)	CU NIPDAU	Level-1-260C-UNLIM
THS4042IDGN	ACTIVE	MSOP-Power PAD	DGN	8	80	Green (RoHS & no Sb/Br)	CU NIPDAU	Level-1-260C-UNLIM
THS4042IDGNG4	ACTIVE	MSOP-Power PAD	DGN	8	80	Green (RoHS & no Sb/Br)	CU NIPDAU	Level-1-260C-UNLIM
THS4042IDGNR	ACTIVE	MSOP-Power PAD	DGN	8	2500	Green (RoHS & no Sb/Br)	CU NIPDAU	Level-1-260C-UNLIM
THS4042IDGNRG4	ACTIVE	MSOP-Power PAD	DGN	8	2500	Green (RoHS & no Sb/Br)	CU NIPDAU	Level-1-260C-UNLIM

⁽¹⁾ The marketing status values are defined as follows:

ACTIVE: Product device recommended for new designs.

LIFEBUY: TI has announced that the device will be discontinued, and a lifetime-buy period is in effect.

NRND: Not recommended for new designs. Device is in production to support existing customers, but TI does not recommend using this part in a new design.

PREVIEW: Device has been announced but is not in production. Samples may or may not be available.

OBSELETE: TI has discontinued the production of the device.

⁽²⁾ Eco Plan - The planned eco-friendly classification: Pb-Free (RoHS), Pb-Free (RoHS Exempt), or Green (RoHS & no Sb/Br) - please check <http://www.ti.com/productcontent> for the latest availability information and additional product content details.

TBD: The Pb-Free/Green conversion plan has not been defined.

Pb-Free (RoHS): TI's terms "Lead-Free" or "Pb-Free" mean semiconductor products that are compatible with the current RoHS requirements for all 6 substances, including the requirement that lead not exceed 0.1% by weight in homogeneous materials. Where designed to be soldered at high temperatures, TI Pb-Free products are suitable for use in specified lead-free processes.

Pb-Free (RoHS Exempt): This component has a RoHS exemption for either 1) lead-based flip-chip solder bumps used between the die and package, or 2) lead-based die adhesive used between the die and leadframe. The component is otherwise considered Pb-Free (RoHS compatible) as defined above.

Green (RoHS & no Sb/Br): TI defines "Green" to mean Pb-Free (RoHS compatible), and free of Bromine (Br) and Antimony (Sb) based flame retardants (Br or Sb do not exceed 0.1% by weight in homogeneous material)

⁽³⁾ MSL, Peak Temp. -- The Moisture Sensitivity Level rating according to the JEDEC industry standard classifications, and peak solder temperature.

Important Information and Disclaimer:The information provided on this page represents TI's knowledge and belief as of the date that it is provided. TI bases its knowledge and belief on information provided by third parties, and makes no representation or warranty as to the accuracy of such information. Efforts are underway to better integrate information from third parties. TI has taken and continues to take reasonable steps to provide representative and accurate information but may not have conducted destructive testing or chemical analysis on incoming materials and chemicals. TI and TI suppliers consider certain information to be proprietary, and thus CAS numbers and other limited information may not be available for release.

In no event shall TI's liability arising out of such information exceed the total purchase price of the TI part(s) at issue in this document sold by TI to Customer on an annual basis.

OTHER QUALIFIED VERSIONS OF THS4041 :

- Automotive: [THS4041-Q1](#)

NOTE: Qualified Version Definitions:

- Automotive - Q100 devices qualified for high-reliability automotive applications targeting zero defects

TAPE AND REEL INFORMATION



QUADRANT ASSIGNMENTS FOR PIN 1 ORIENTATION IN TAPE



*All dimensions are nominal

Device	Package Type	Package Drawing	Pins	SPQ	Reel Diameter (mm)	Reel Width W1 (mm)	A0 (mm)	B0 (mm)	K0 (mm)	P1 (mm)	W (mm)	Pin1 Quadrant
THS4041CDGNR	MSOP-Power PAD	DGN	8	2500	330.0	12.4	5.2	3.3	1.6	8.0	12.0	Q1
THS4041CDR	SOIC	D	8	2500	330.0	12.4	6.4	5.2	2.1	8.0	12.0	Q1
THS4041IDGNR	MSOP-Power PAD	DGN	8	2500	330.0	12.4	5.2	3.3	1.6	8.0	12.0	Q1
THS4041IDR	SOIC	D	8	2500	330.0	12.4	6.4	5.2	2.1	8.0	12.0	Q1
THS4042CDGNR	MSOP-Power PAD	DGN	8	2500	330.0	12.4	5.2	3.3	1.6	8.0	12.0	Q1
THS4042IDGNR	MSOP-Power PAD	DGN	8	2500	330.0	12.4	5.2	3.3	1.6	8.0	12.0	Q1

TAPE AND REEL BOX DIMENSIONS

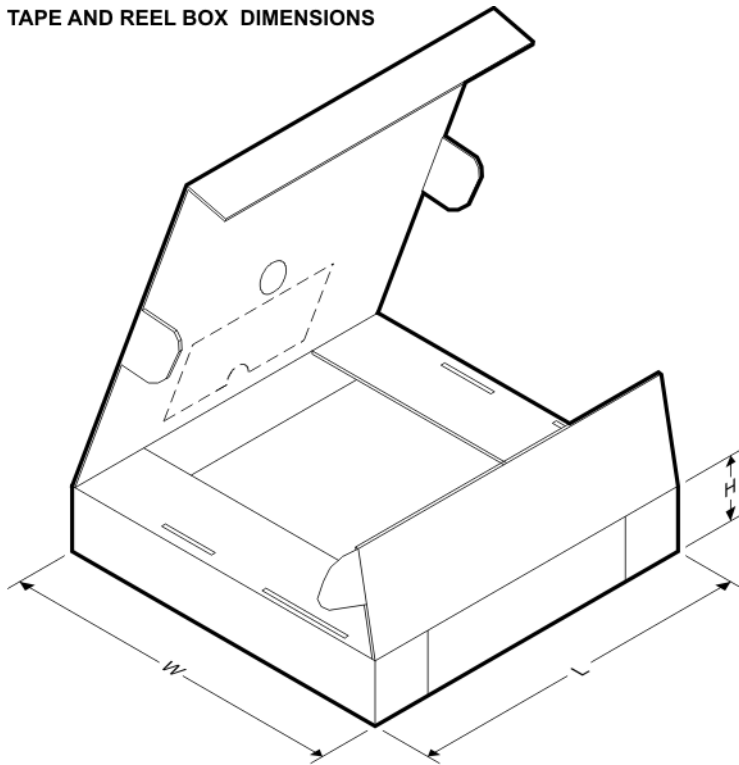

*All dimensions are nominal

Device	Package Type	Package Drawing	Pins	SPQ	Length (mm)	Width (mm)	Height (mm)
THS4041CDGNR	MSOP-PowerPAD	DGN	8	2500	338.1	340.5	21.1
THS4041CDR	SOIC	D	8	2500	346.0	346.0	29.0
THS4041IDGNR	MSOP-PowerPAD	DGN	8	2500	338.1	340.5	21.1
THS4041IDR	SOIC	D	8	2500	346.0	346.0	29.0
THS4042CDGNR	MSOP-PowerPAD	DGN	8	2500	338.1	340.5	21.1
THS4042IDGNR	MSOP-PowerPAD	DGN	8	2500	338.1	340.5	21.1

MECHANICAL DATA

DGN (S-PDSO-G8)

PowerPAD™ PLASTIC SMALL-OUTLINE PACKAGE

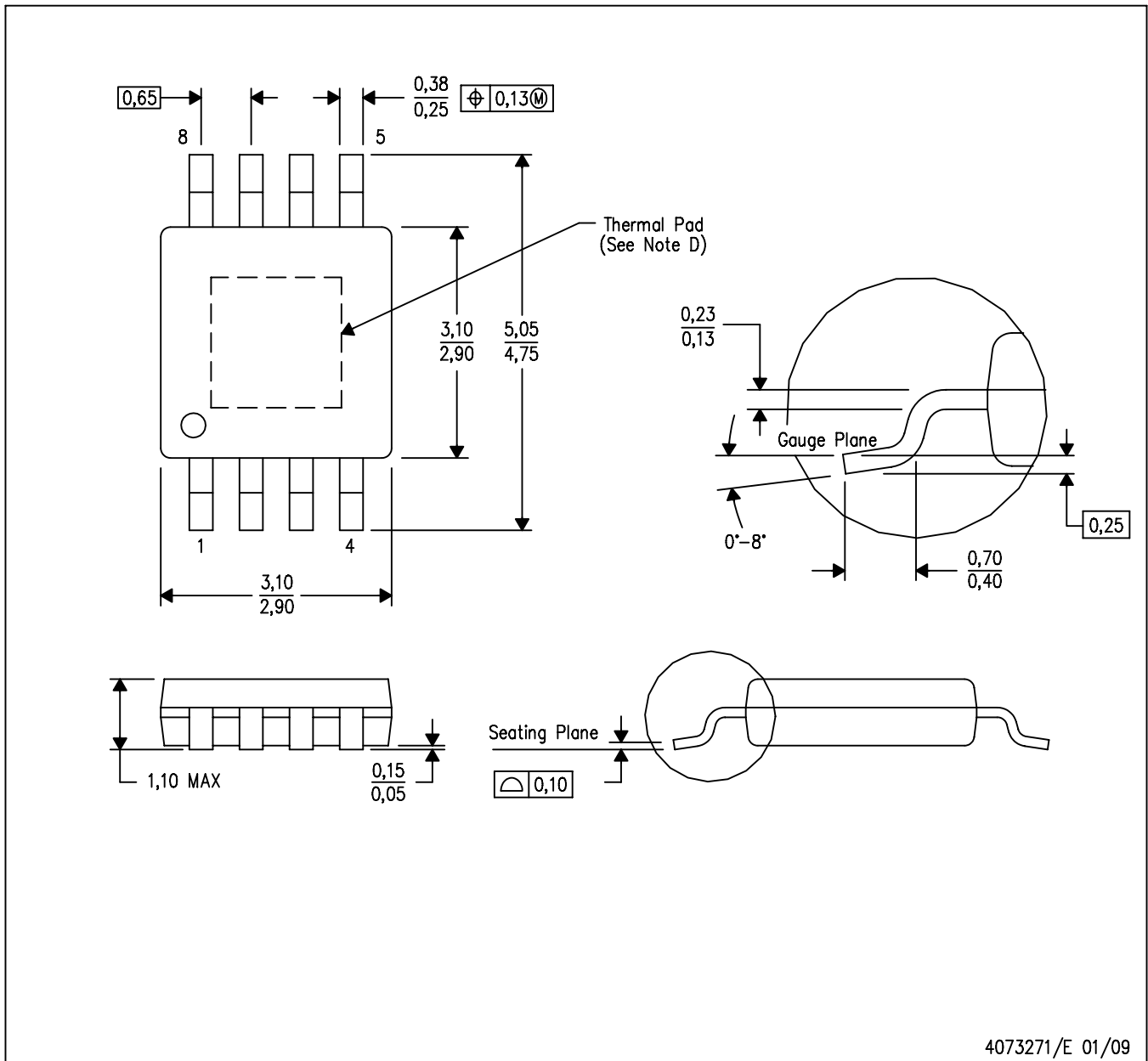

4073271/E 01/09

- NOTES:
- All linear dimensions are in millimeters.
 - This drawing is subject to change without notice.
 - Body dimensions do not include mold flash or protrusion.
 - This package is designed to be soldered to a thermal pad on the board. Refer to Technical Brief, PowerPAD Thermally Enhanced Package, Texas Instruments Literature No. SLMA002 for information regarding recommended board layout. This document is available at www.ti.com <<http://www.ti.com>>.
 - Falls within JEDEC MO-187 variation AA-T

PowerPAD is a trademark of Texas Instruments.

THERMAL INFORMATION

This PowerPAD™ package incorporates an exposed thermal pad that is designed to be attached directly to an external heatsink. The thermal pad must be soldered directly to the printed circuit board (PCB). After soldering, the PCB can be used as a heatsink. In addition, through the use of thermal vias, the thermal pad can be attached directly to the appropriate copper plane shown in the electrical schematic for the device, or alternatively, can be attached to a special heatsink structure designed into the PCB. This design optimizes the heat transfer from the integrated circuit (IC).

For additional information on the PowerPAD package and how to take advantage of its heat dissipating abilities, refer to Technical Brief, PowerPAD Thermally Enhanced Package, Texas Instruments Literature No. SLMA002 and Application Brief, PowerPAD Made Easy, Texas Instruments Literature No. SLMA004. Both documents are available at www.ti.com.

The exposed thermal pad dimensions for this package are shown in the following illustration.

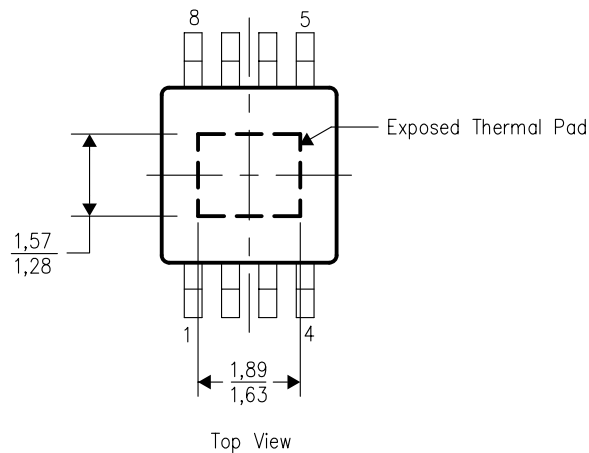

NOTE: All linear dimensions are in millimeters

Exposed Thermal Pad Dimensions

DGN (R-PDS0-G8) PowerPAD™

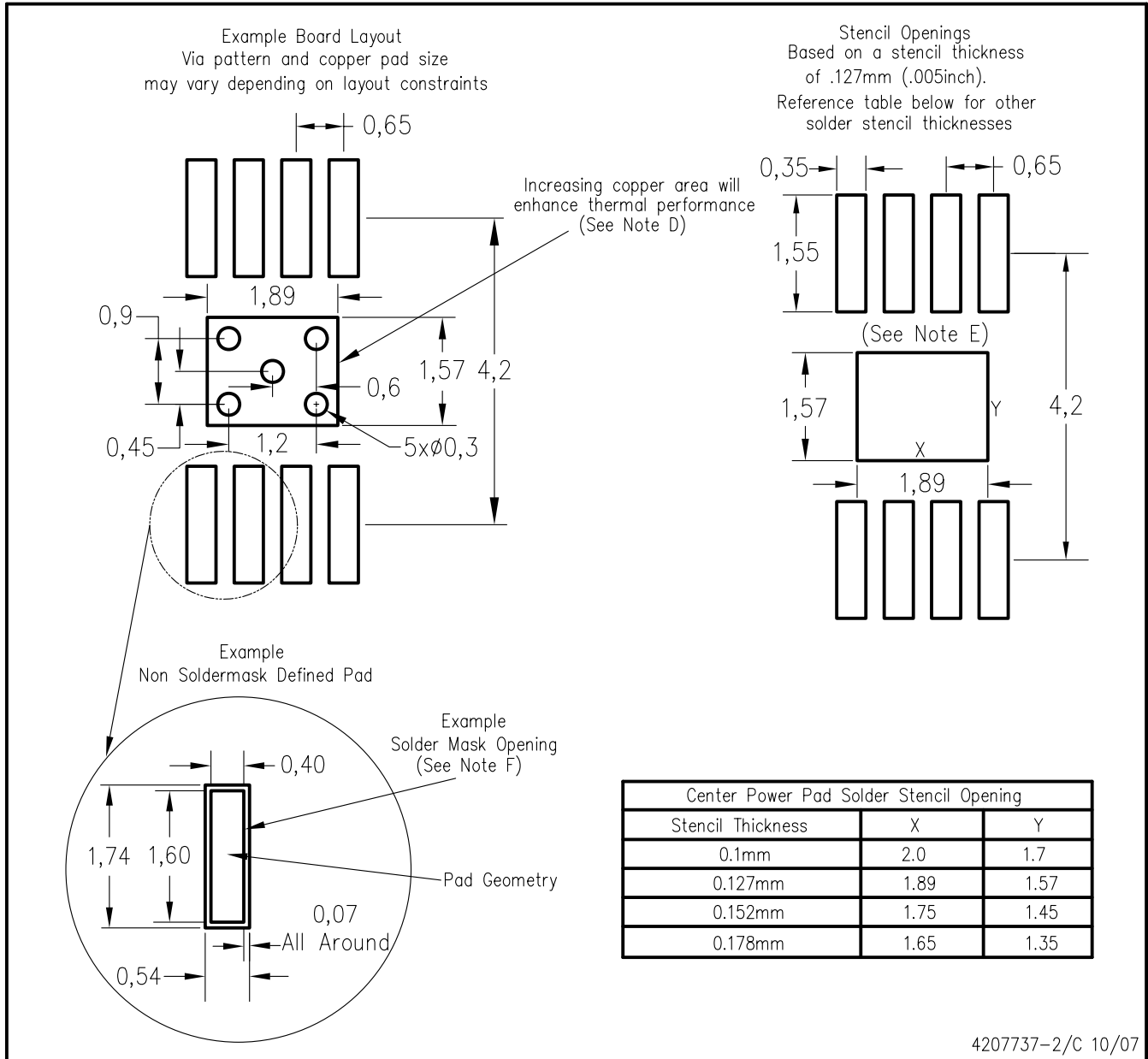

- NOTES:
- A. All linear dimensions are in millimeters.
 - B. This drawing is subject to change without notice.
 - C. Customers should place a note on the circuit board fabrication drawing not to alter the center solder mask defined pad.
 - D. This package is designed to be soldered to a thermal pad on the board. Refer to Technical Brief, PowerPad Thermally Enhanced Package, Texas Instruments Literature No. SLMA002, SLMA004, and also the Product Data Sheets for specific thermal information, via requirements, and recommended board layout. These documents are available at www.ti.com <<http://www.ti.com>>. Publication IPC-7351 is recommended for alternate designs.
 - E. Laser cutting apertures with trapezoidal walls and also rounding corners will offer better paste release. Customers should contact their board assembly site for stencil design recommendations. Example stencil design based on a 50% volumetric metal load solder paste. Refer to IPC-7525 for other stencil recommendations.
 - F. Customers should contact their board fabrication site for solder mask tolerances between and around signal pads.

D (R-PDSO-G8)

PLASTIC SMALL-OUTLINE PACKAGE

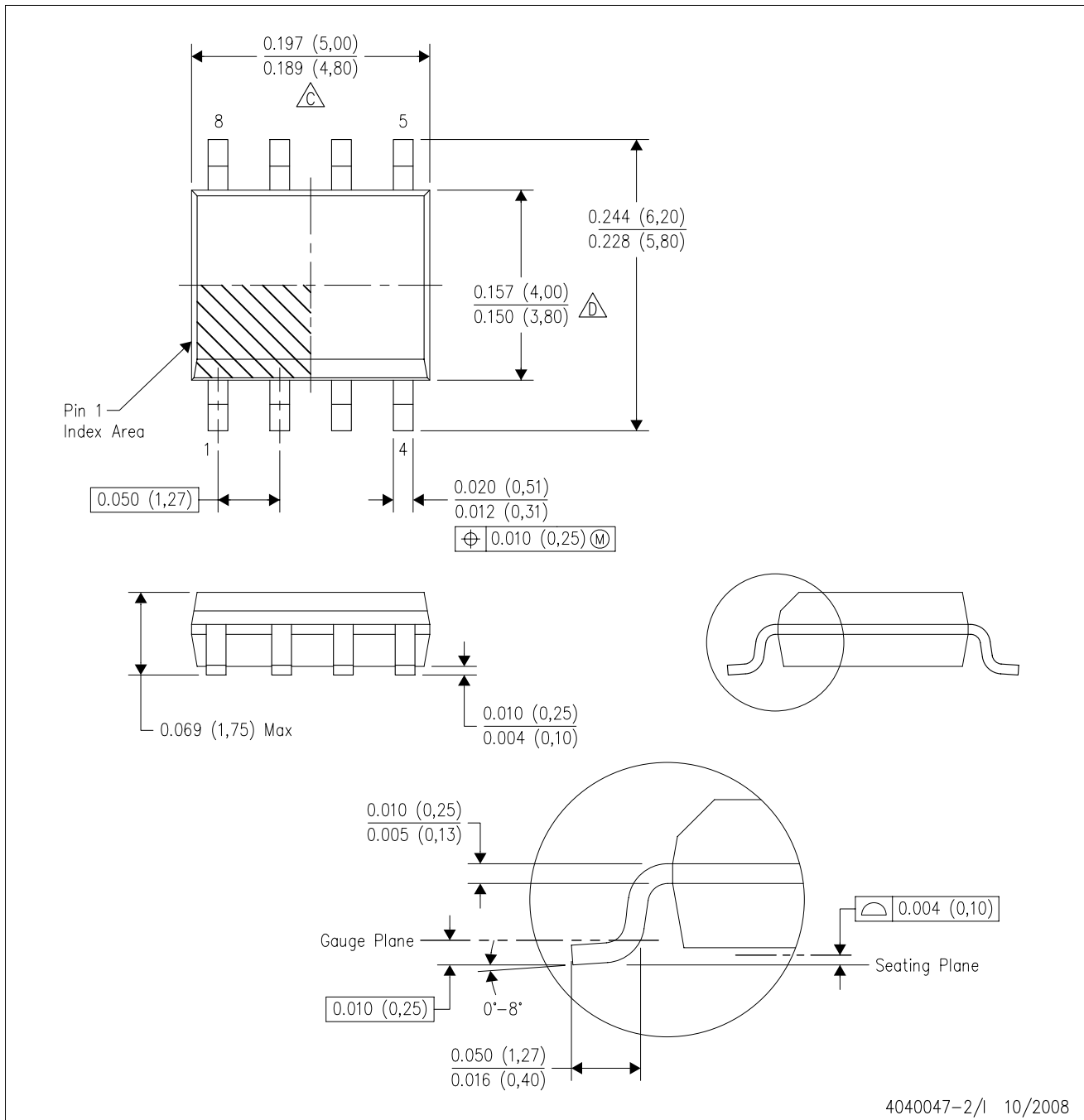

NOTES: A. All linear dimensions are in inches (millimeters).
 B. This drawing is subject to change without notice.
 C. Body length does not include mold flash, protrusions, or gate burrs. Mold flash, protrusions, or gate burrs shall not exceed .006 (0,15) per end.
 D. Body width does not include interlead flash. Interlead flash shall not exceed .017 (0,43) per side.
 E. Reference JEDEC MS-012 variation AA.

IMPORTANT NOTICE

Texas Instruments Incorporated and its subsidiaries (TI) reserve the right to make corrections, modifications, enhancements, improvements, and other changes to its products and services at any time and to discontinue any product or service without notice. Customers should obtain the latest relevant information before placing orders and should verify that such information is current and complete. All products are sold subject to TI's terms and conditions of sale supplied at the time of order acknowledgment.

TI warrants performance of its hardware products to the specifications applicable at the time of sale in accordance with TI's standard warranty. Testing and other quality control techniques are used to the extent TI deems necessary to support this warranty. Except where mandated by government requirements, testing of all parameters of each product is not necessarily performed.

TI assumes no liability for applications assistance or customer product design. Customers are responsible for their products and applications using TI components. To minimize the risks associated with customer products and applications, customers should provide adequate design and operating safeguards.

TI does not warrant or represent that any license, either express or implied, is granted under any TI patent right, copyright, mask work right, or other TI intellectual property right relating to any combination, machine, or process in which TI products or services are used. Information published by TI regarding third-party products or services does not constitute a license from TI to use such products or services or a warranty or endorsement thereof. Use of such information may require a license from a third party under the patents or other intellectual property of the third party, or a license from TI under the patents or other intellectual property of TI.

Reproduction of TI information in TI data books or data sheets is permissible only if reproduction is without alteration and is accompanied by all associated warranties, conditions, limitations, and notices. Reproduction of this information with alteration is an unfair and deceptive business practice. TI is not responsible or liable for such altered documentation. Information of third parties may be subject to additional restrictions.

Resale of TI products or services with statements different from or beyond the parameters stated by TI for that product or service voids all express and any implied warranties for the associated TI product or service and is an unfair and deceptive business practice. TI is not responsible or liable for any such statements.

TI products are not authorized for use in safety-critical applications (such as life support) where a failure of the TI product would reasonably be expected to cause severe personal injury or death, unless officers of the parties have executed an agreement specifically governing such use. Buyers represent that they have all necessary expertise in the safety and regulatory ramifications of their applications, and acknowledge and agree that they are solely responsible for all legal, regulatory and safety-related requirements concerning their products and any use of TI products in such safety-critical applications, notwithstanding any applications-related information or support that may be provided by TI. Further, Buyers must fully indemnify TI and its representatives against any damages arising out of the use of TI products in such safety-critical applications.

TI products are neither designed nor intended for use in military/aerospace applications or environments unless the TI products are specifically designated by TI as military-grade or "enhanced plastic." Only products designated by TI as military-grade meet military specifications. Buyers acknowledge and agree that any such use of TI products which TI has not designated as military-grade is solely at the Buyer's risk, and that they are solely responsible for compliance with all legal and regulatory requirements in connection with such use.

TI products are neither designed nor intended for use in automotive applications or environments unless the specific TI products are designated by TI as compliant with ISO/TS 16949 requirements. Buyers acknowledge and agree that, if they use any non-designated products in automotive applications, TI will not be responsible for any failure to meet such requirements.

Following are URLs where you can obtain information on other Texas Instruments products and application solutions:

Products

Amplifiers	amplifier.ti.com
Data Converters	dataconverter.ti.com
DLP® Products	www.dlp.com
DSP	dsp.ti.com
Clocks and Timers	www.ti.com/clocks
Interface	interface.ti.com
Logic	logic.ti.com
Power Mgmt	power.ti.com
Microcontrollers	microcontroller.ti.com
RFID	www.ti-rfid.com
RF/IF and ZigBee® Solutions	www.ti.com/lprf

Applications

Audio	www.ti.com/audio
Automotive	www.ti.com/automotive
Broadband	www.ti.com/broadband
Digital Control	www.ti.com/digitalcontrol
Medical	www.ti.com/medical
Military	www.ti.com/military
Optical Networking	www.ti.com/opticalnetwork
Security	www.ti.com/security
Telephony	www.ti.com/telephony
Video & Imaging	www.ti.com/video
Wireless	www.ti.com/wireless

Mailing Address: Texas Instruments, Post Office Box 655303, Dallas, Texas 75265
Copyright © 2009, Texas Instruments Incorporated