

LOW NOISE, HIGH SLEW RATE, UNITY GAIN STABLE VOLTAGE FEEDBACK AMPLIFIER

FEATURES

- **Controlled Baseline**
 - One Assembly/Test Site, One Fabrication Site
- **Extended Temperature Performance of -55°C to 125°C**
- **Enhanced Diminishing Manufacturing Sources (DMS) Support**
- **Enhanced Product-Change Notification**
- **Qualification Pedigree⁽¹⁾**
- **Unity Gain Stability**
- **Low Voltage Noise**
 - $3\text{ nV}/\sqrt{\text{Hz}}$
- **High Slew Rate: $1000\text{ V}/\mu\text{s}$**
- **Low Distortion**
 - $-92\text{ dBc THD at } 30\text{ MHz}$
- **Wide Bandwidth: 1.4 GHz**
- **Supply Voltages**
 - $+5\text{ V}, \pm 5\text{ V}, +12\text{ V}, +15\text{ V}$
- **Power Down Functionality (THS4275)**
- **Evaluation Module Available**

⁽¹⁾ Component qualification in accordance with JEDEC and industry standards to ensure reliable operation over an extended temperature range. This includes, but is not limited to, Highly Accelerated Stress Test (HAST) or biased 85/85, temperature cycle, autoclave or unbiased HAST, electromigration, bond intermetallic life, and mold compound life. Such qualification testing should not be viewed as justifying use of this component beyond specified performance and environmental limits.

APPLICATIONS

- **High Linearity ADC Preamplifier**
- **Wireless Communication Receivers**
- **Differential to Single-Ended Conversion**
- **DAC Output Buffer**
- **Active Filtering**

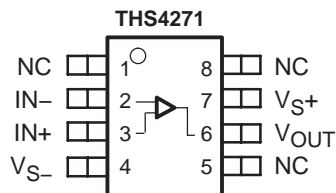

DESCRIPTION

The THS4271 and THS4275 are low-noise, high slew rate, unity gain stable voltage feedback amplifiers designed to run from supply voltages as low as 5 V and as high as 15 V. The THS4275 offers the same performance as the THS4271 with the addition of power down capability. The combination of low-noise, high slew rate, wide bandwidth, low distortion, and unity gain stability make the THS4271 and THS4275 high performance devices across multiple ac specifications.

Designers using the THS4271 are rewarded with higher dynamic range over a wider frequency band without the stability concerns of decompensated amplifiers. The devices are available in SOIC, MSOP with PowerPAD™, and leadless MSOP with PowerPAD™ packages.

RELATED DEVICES

| DEVICE | DESCRIPTION |
|---------|---|
| THS4211 | 1-GHz voltage feedback amplifier |
| THS4503 | Wideband fully differential amplifier |
| THS3202 | Dual, wideband current feedback amplifier |

HARMONIC AND INTERMODULATION DISTORTION vs FREQUENCY

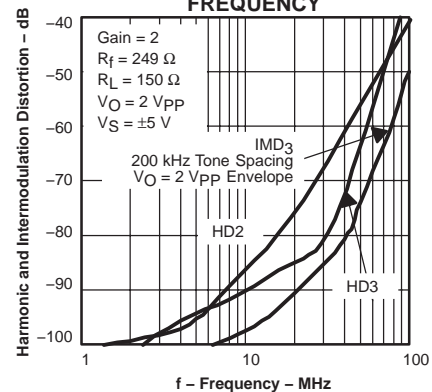

Please be aware that an important notice concerning availability, standard warranty, and use in critical applications of Texas Instruments semiconductor products and disclaimers thereto appears at the end of this data sheet.

PowerPAD is a trademark of Texas Instruments.

Low-Noise, Low-Distortion, Wideband Application Circuit

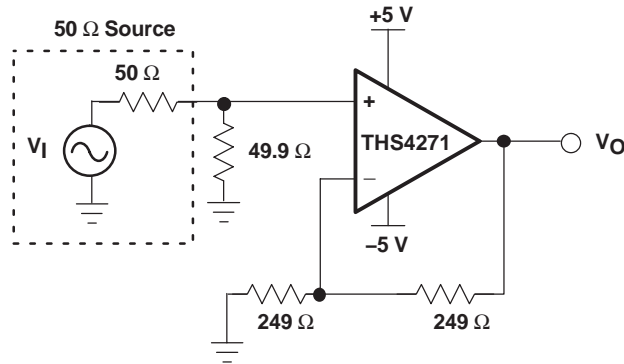

NOTE: Power supply decoupling capacitors not shown

ABSOLUTE MAXIMUM RATINGS

over operating free-air temperature range unless otherwise noted⁽¹⁾

| | UNIT | |
|---|----------------------------------|--------|
| Supply voltage, V_S | 16.5 V | |
| Input voltage, V_I | $\pm V_S$ | |
| Output current, I_O | 100 mA | |
| Continuous power dissipation | See the Dissipation Rating Table | |
| Maximum junction temperature, T_J | 150°C | |
| Maximum junction temperature, continuous operation, long term reliability T_J (2) | 125°C | |
| Storage temperature range, T_{stg} | -65°C to 150°C | |
| Lead temperature 1,6 mm (1/16 inch) from case for 10 seconds | 300°C | |
| ESD ratings: | HBM | 3000 V |
| | CDM | 1000 V |
| | MM | 100 V |

(1) The absolute maximum temperature under any condition is limited by the constraints of the silicon process. Stresses above these ratings may cause permanent damage. Exposure to absolute maximum conditions for extended periods may degrade device reliability. These are stress ratings only and functional operation of the device at these or any other conditions beyond those specified is not implied.

(2) Long-term high-temperature storage and/or extended use at maximum recommended operating conditions may result in a reduction of overall device life. See Figure 1 for additional information on thermal derating.



This integrated circuit can be damaged by ESD. Texas Instruments recommends that all integrated circuits be handled with appropriate precautions. Failure to observe proper handling and installation procedures can cause damage.

ESD damage can range from subtle performance degradation to complete device failure. Precision integrated circuits may be more susceptible to damage because very small parametric changes could cause the device not to meet its published specifications.

PACKAGE DISSIPATION RATINGS

| PACKAGE | θ_{JC} (°C/W) | $\theta_{JA}^{(1)}$ (°C/W) |
|----------------------------|-------------------------|-------------------------------|
| D (8 pin) | 38.3 | 97.5 |
| DGN (8 pin) ⁽²⁾ | 4.7 | 58.4 |

(1) This data was taken using the JEDEC standard High-K test PCB.

(2) The THS4271/5 may incorporate a PowerPAD™ on the underside of the chip. This acts as a heat sink and must be connected to a thermally dissipative plane for proper power dissipation. Failure to do so may result in exceeding the maximum junction temperature which could permanently damage the device. See Texas Instruments technical briefs SLMA002 and SLMA004 for more information about utilizing the PowerPAD thermally enhanced package.

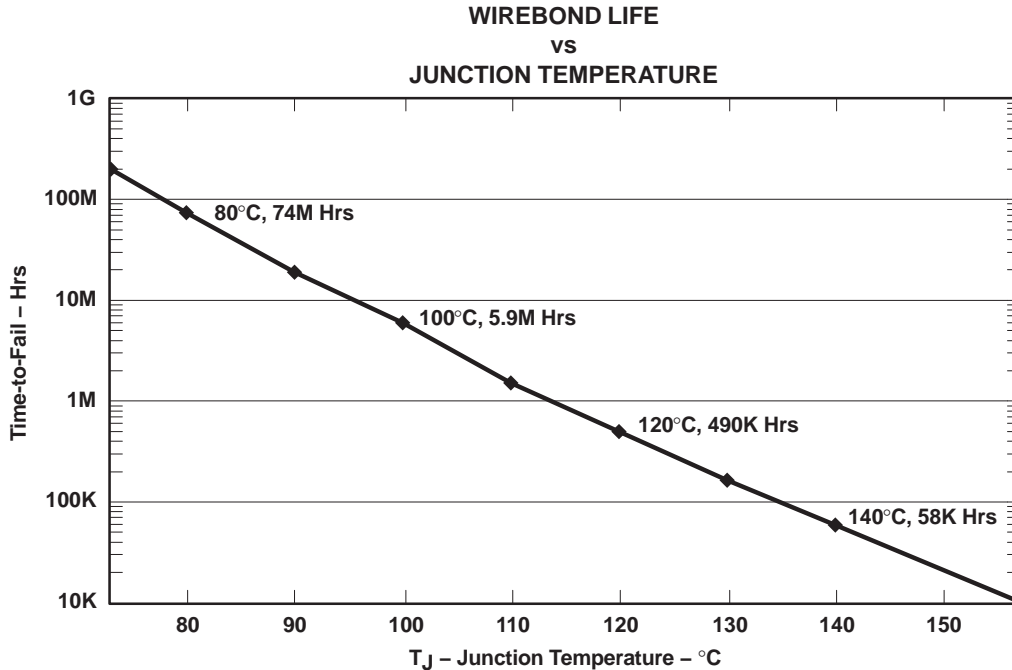

Figure 1. EME-G600 Estimated Wirebond Life

RECOMMENDED OPERATING CONDITIONS

| | | MIN | MAX | UNIT |
|--|---------------|-----------------------|-----------------------|------|
| Supply voltage, (V _{S+} and V _{S-}) | Dual supply | ±2.5 | ±7.5 | V |
| | Single supply | 5 | 15 | |
| Input common-mode voltage range | | V _{S-} + 1.4 | V _{S+} - 1.4 | V |
| Operating free-air temperature, T _A | | -55 | 125 | °C |

PACKAGING/ORDERING INFORMATION

| ORDERABLE PACKAGE AND NUMBER | | |
|-------------------------------|---------------------------|-----------------|
| PLASTIC SMALL OUTLINE (D) (1) | PLASTIC MSOP (1) PowerPAD | |
| | (DGN) | PACKAGE MARKING |
| THS4271MDEP(2) | THS4271MDGNTEP(2) | BLT |
| THS4271MDREP(2) | THS4271MDGNREP | |
| THS4275MDEP(2) | THS4275MDGNTEP(2) | BLY |
| THS4275MDREP(2) | THS4275MDGNREP(2) | |

(1) All packages are available taped and reeled. The R suffix standard quantity is 2500 (e.g., THS4271MDGNREP).

(2) Product Preview

PIN ASSIGNMENTS

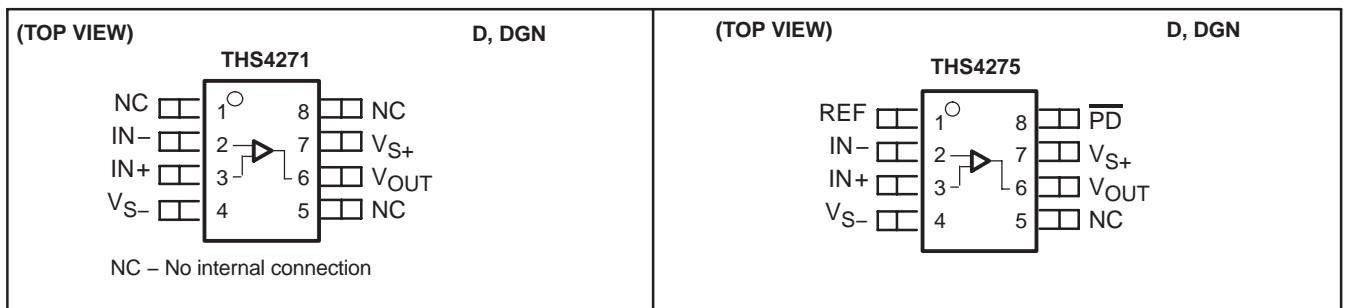

ELECTRICAL CHARACTERISTICS $V_S = \pm 5\text{ V}$

$R_F = 301\ \Omega$, $R_L = 499\ \Omega$, $G = +2$, unless otherwise noted

| PARAMETER | TEST CONDITIONS | TYP | OVER TEMPERATURE | | | MIN/ TYP/ MAX |
|--|---|---------|------------------|-------------------|------------------------------|---------------------|
| | | 25°C | 25°C | -55°C TO 125°C | UNITS | |
| AC PERFORMANCE | | | | | | |
| Small signal bandwidth | $G = 1, V_O = 100\text{ mV}_{PP}, R_L = 150\ \Omega$ | 1.4 | | | GHz | Typ |
| | $G = -1, V_O = 100\text{ mV}_{PP}$ | 400 | | | MHz | |
| | $G = 2, V_O = 100\text{ mV}_{PP}$ | 390 | | | MHz | |
| | $G = 5, V_O = 100\text{ mV}_{PP}$ | 85 | | | MHz | |
| | $G = 10, V_O = 100\text{ mV}_{PP}$ | 40 | | | MHz | |
| 0.1-dB flat bandwidth | $G = 1, V_O = 100\text{ mV}_{PP}, R_L = 150\ \Omega$ | 200 | | | MHz | Typ |
| Gain bandwidth product | $G > 10, f = 1\text{ MHz}$ | 400 | | | MHz | Typ |
| Full-power bandwidth | $G = -1, V_O = 2\text{ V}_p$ | 80 | | | MHz | Typ |
| Slew rate | $G = 1, V_O = 2\text{ V Step}$ | 950 | | | V/ μ s | Typ |
| | $G = -1, V_O = 2\text{ V Step}$ | 1000 | | | | |
| Settling time to 0.1% | $G = -1, V_O = 4\text{ V Step}$ | 25 | | | ns | Typ |
| Settling time to 0.01% | $G = -1, V_O = 4\text{ V Step}$ | 38 | | | ns | Typ |
| Harmonic distortion | $G = 1, V_O = 1\text{ V}_{PP}, f = 30\text{ MHz}$ | | | | | |
| Second harmonic distortion | $R_L = 150\ \Omega$ | -92 | | | dBc | Typ |
| | $R_L = 499\ \Omega$ | -80 | | | | |
| Third harmonic distortion | $R_L = 150\ \Omega$ | -95 | | | dBc | Typ |
| | $R_L = 499\ \Omega$ | -95 | | | | |
| Harmonic distortion | $G = 2, V_O = 2\text{ V}_{PP}, f = 30\text{ MHz}$ | | | | | |
| Second harmonic distortion | $R_L = 150\ \Omega$ | -65 | | | dBc | Typ |
| | $R_L = 499\ \Omega$ | -70 | | | | |
| Third harmonic distortion | $R_L = 150\ \Omega$ | -80 | | | dBc | Typ |
| | $R_L = 499\ \Omega$ | -90 | | | | |
| Third order intermodulation (IMD ₃) | $G = 2, V_O = 2\text{ V}_{PP}, R_L = 150\ \Omega,$ $f = 70\text{ MHz}$ | -60 | | | dBc | Typ |
| Third order output intercept (OIP ₃) | $G = 2, V_O = 2\text{ V}_{PP}, R_L = 150\ \Omega,$ $f = 70\text{ MHz}$ | 35 | | | dBm | Typ |
| Differential gain (NTSC, PAL) | $G = 2, R_L = 150\ \Omega$ | 0.007% | | | | Typ |
| Differential phase (NTSC, PAL) | $G = 2, R_L = 150\ \Omega$ | 0.004 | | | degrees | Typ |
| Input voltage noise | $f = 1\text{ MHz}$ | 3 | | | nV/ $\sqrt{\text{Hz}}$ | Typ |
| Input current noise | $f = 1\text{ MHz}$ | 3 | | | pA/ $\sqrt{\text{Hz}}$ | Typ |
| DC PERFORMANCE | | | | | | |
| Open-loop voltage gain (A _{OL}) | $V_O = \pm 50\text{ mV}, R_L = 499\ \Omega$ | 75 | 65 | 56 | dB | Min |
| Input offset voltage | $V_{CM} = 0\text{ V}$ | 5 | ± 14 | ± 16 | mV | Max |
| Average offset voltage drift | $V_{CM} = 0\text{ V}$ | | | ± 10 | $\mu\text{V}/^\circ\text{C}$ | Typ |
| Input bias current | $V_{CM} = 0\text{ V}$ | 6 | 15 | 18 | μA | Max |
| Average bias current drift | $V_{CM} = 0\text{ V}$ | | | ± 10 | nA/ $^\circ\text{C}$ | Typ |
| Input offset current | $V_{CM} = 0\text{ V}$ | 1 | 6 | 8 | μA | Max |
| Average offset current drift | $V_{CM} = 0\text{ V}$ | | | ± 10 | nA/ $^\circ\text{C}$ | Typ |
| INPUT CHARACTERISTICS | | | | | | |
| Common-mode input range | | ± 4 | ± 3.6 | ± 3.5 | V | Min |
| Common-mode rejection ratio | $V_{CM} = \pm 1\text{ V}$ | 72 | 67 | 62 | dB | Min |
| Input resistance | Common-mode | 5 | | | M Ω | Typ |
| Input capacitance | Common-mode / differential | 0.4/0.8 | | | pF | Typ |

ELECTRICAL CHARACTERISTICS $V_S = \pm 5$ V (CONTINUED)

$R_F = 301 \Omega$, $R_L = 499 \Omega$, $G = +2$, unless otherwise noted

| PARAMETER | TEST CONDITIONS | TYP | OVER TEMPERATURE | | | MIN/ TYP/ MAX | |
|--|--|------------|------------------|-------------------|-----------|---------------------|-----|
| | | 25°C | 25°C | -55°C to 125°C | UNITS | | |
| OUTPUT CHARACTERISTICS | | | | | | | |
| Output voltage swing | $G = +2$ | ± 4 | ± 3.75 | ± 3.6 | V | Min | |
| Output current (sourcing) | $R_L = 10 \Omega$ | 160 | 120 | 104 | mA | Min | |
| Output current (sinking) | $R_L = 10 \Omega$ | 80 | 60 | 44 | mA | Min | |
| Output impedance | $f = 1$ MHz | 0.1 | | | Ω | Typ | |
| POWER SUPPLY | | | | | | | |
| Specified operating voltage | | ± 5 | ± 7.5 | ± 7.5 | V | Max | |
| Maximum quiescent current | | 22 | 24 | 34 | mA | Max | |
| Minimum quiescent current | | 22 | 20 | 13 | mA | Min | |
| Power supply rejection (+PSRR) | $V_{S+} = 5.5$ V to 4.5 V, $V_{S-} = -5$ V | 85 | 75 | 58 | dB | Min | |
| Power supply rejection (-PSRR) | $V_{S+} = 5$ V, $V_{S-} = -5.5$ V to -4.5 V | 75 | 65 | 57 | dB | Min | |
| POWER-DOWN CHARACTERISTICS (THS4275 only) | | | | | | | |
| Power-down voltage level ⁽¹⁾ | $REF = 0$ V, or V_{S-} | Enable | | REF+1.8 | | V | Min |
| | | Power down | | REF+1 | | V | Max |
| | $REF = V_{S+}$ or Floating | Enable | | REF-1 | | V | Min |
| | | Power down | | REF-1.7 | | V | Max |
| Power-down quiescent current | PD = Ref +1 V, Ref = 0 V | 875 | 1000 | 1200 | μ A | Max | |
| | PD = Ref -1.7 V, Ref = V_{S+} | 650 | 800 | 1000 | μ A | Max | |
| Turnon time delay (t_{ON}) | 50% of final supply current value | 4 | | | μ s | Typ | |
| Turnoff time delay (t_{OFF}) | 50% of final supply current value | 3 | | | μ s | Typ | |
| Input impedance | $f = 1$ MHz | 4 | | | $G\Omega$ | Typ | |
| Output impedance | | 200 | | | $k\Omega$ | Typ | |

(1) For detailed information on the power-down circuit, see the *powerdown* section in the *Application Information* section of this data sheet.

ELECTRICAL CHARACTERISTICS $V_S = 5\text{ V}$

$R_F = 301\ \Omega$, $R_L = 499\ \Omega$, $G = +2$, unless otherwise noted

| PARAMETER | TEST CONDITIONS | TYP | OVER TEMPERATURE | | | MIN/ TYP/ MAX |
|--|---|---------|------------------|-------------------|------------------------------|---------------------|
| | | 25°C | 25°C | -55°C to 125°C | UNITS | |
| AC PERFORMANCE | | | | | | |
| Small signal bandwidth | $G = 1, V_O = 100\text{ mV}_{PP}, R_L = 150\ \Omega$ | 1.2 | | | GHz | Typ |
| | $G = -1, V_O = 100\text{ mV}_{PP}$ | 380 | | | MHz | |
| | $G = 2, V_O = 100\text{ mV}_{PP}$ | 360 | | | MHz | |
| | $G = 5, V_O = 100\text{ mV}_{PP}$ | 80 | | | MHz | |
| | $G = 10, V_O = 100\text{ mV}_{PP}$ | 35 | | | MHz | |
| 0.1-dB flat bandwidth | $G = 1, V_O = 100\text{ mV}_{PP}, R_L = 150\ \Omega$ | 120 | | | MHz | Typ |
| Gain bandwidth product | $G > 10, f = 1\text{ MHz}$ | 350 | | | MHz | Typ |
| Full-power bandwidth | $G = -1, V_O = 2\text{ V}_p$ | 60 | | | MHz | Typ |
| Slew rate | $G = 1, V_O = 2\text{ V Step}$ | 700 | | | V/ μ s | Typ |
| | $G = -1, V_O = 2\text{ V Step}$ | 750 | | | | |
| Settling time to 0.1% | $G = -1, V_O = 2\text{ V Step}$ | 18 | | | ns | Typ |
| Settling time to 0.01% | $G = -1, V_O = 2\text{ V Step}$ | 66 | | | ns | Typ |
| Harmonic distortion | $G = 1, V_O = 1\text{ V}_{PP}, f = 30\text{ MHz}$ | | | | | |
| Second harmonic distortion | $R_L = 150\ \Omega$ | -75 | | | dBc | Typ |
| | $R_L = 499\ \Omega$ | -72 | | | | |
| Third harmonic distortion | $R_L = 150\ \Omega$ | -70 | | | dBc | Typ |
| | $R_L = 499\ \Omega$ | -70 | | | | |
| Third order intermodulation (IMD ₃) | $G = 2, V_O = 1\text{ V}_{PP}, R_L = 150\ \Omega,$ $f = 70\text{ MHz}$ | -65 | | | dBc | Typ |
| Third order output intercept (OIP ₃) | $G = 2, V_O = 1\text{ V}_{PP}, R_L = 150\ \Omega,$ $f = 70\text{ MHz}$ | 32 | | | dBm | Typ |
| Input voltage noise | $f = 1\text{ MHz}$ | 3 | | | nV/ $\sqrt{\text{Hz}}$ | Typ |
| Input current noise | $f = 10\text{ MHz}$ | 3 | | | pA/ $\sqrt{\text{Hz}}$ | Typ |
| DC PERFORMANCE | | | | | | |
| Open-loop voltage gain (A _{OL}) | $V_O = \pm 50\text{ mV}, R_L = 499\ \Omega$ | 68 | 63 | 56 | dB | Min |
| Input offset voltage | $V_{CM} = V_S/2$ | 5 | ± 14 | ± 16 | mV | Max |
| Average offset voltage drift | $V_{CM} = V_S/2$ | | | ± 10 | $\mu\text{V}/^\circ\text{C}$ | Typ |
| Input bias current | $V_{CM} = V_S/2$ | 6 | 15 | 18 | μA | Max |
| Average bias current drift | $V_{CM} = V_S/2$ | | | ± 10 | nA/ $^\circ\text{C}$ | Typ |
| Input offset current | $V_{CM} = V_S/2$ | 1 | 6 | 8 | μA | Max |
| Average offset current drift | $V_{CM} = V_S/2$ | | | ± 10 | nA/ $^\circ\text{C}$ | Typ |
| INPUT CHARACTERISTICS | | | | | | |
| Common-mode input range | | 1/4 | 1.3/3.7 | 1.5/3.5 | V | Min |
| Common-mode rejection ratio | $V_{CM} = \pm 0.5\text{ V}, V_O = 2.5\text{ V}$ | 72 | 67 | 62 | dB | Min |
| Input resistance | Common-mode | 5 | | | M Ω | Typ |
| Input capacitance | Common-mode / differential | 0.4/0.8 | | | pF | Typ |
| OUTPUT CHARACTERISTICS | | | | | | |
| Output voltage swing | $G = +2$ | 1.2/3.8 | 1.4/3.6 | 1.5/3.5 | V | Min |
| Output current (sourcing) | $R_L = 10\ \Omega$ | 120 | 90 | 78 | mA | Min |
| Output current (sinking) | $R_L = 10\ \Omega$ | 65 | 45 | 37 | mA | Min |
| Output impedance | $f = 1\text{ MHz}$ | 0.1 | | | Ω | Typ |

ELECTRICAL CHARACTERISTICS $V_S = 5\text{ V}$ (CONTINUED)
 $R_F = 301\ \Omega$, $R_L = 499\ \Omega$, $G = +2$, unless otherwise noted

| PARAMETER | TEST CONDITIONS | TYP | OVER TEMPERATURE | | | MIN/ TYP/ MAX | |
|--|---|------------|------------------|-------------------|------------------|---------------------|-----|
| | | 25°C | 25°C | -55°C to 125°C | UNITS | | |
| POWER SUPPLY | | | | | | | |
| Specified operating voltage | | 5 | 15 | 15 | V | Max | |
| Maximum quiescent current | | 20 | 23 | 34 | mA | Max | |
| Minimum quiescent current | | 20 | 18 | 13 | mA | Min | |
| Power supply rejection (+PSRR) | $V_{S+} = 5.5\text{ V to } 4.5\text{ V}$, $V_{S-} = 0\text{ V}$ | 85 | 70 | 57 | dB | Min | |
| Power supply rejection (-PSRR) | $V_{S+} = 5\text{ V}$, $V_{S-} = -0.5\text{ V to } 0.5\text{ V}$ | 75 | 65 | 56 | dB | Min | |
| POWER-DOWN CHARACTERISTICS (THS4275 Only) | | | | | | | |
| Power-down voltage level ⁽¹⁾ | REF = 0 V, or V_{S-} | Enable | | REF+1.8 | | V | Min |
| | | Power down | | REF+1 | | V | Max |
| | REF = V_{S+} or Floating | Enable | | REF-1 | | V | Min |
| | | Power down | | REF-1.7 | | V | Max |
| Power-down quiescent current | PD = Ref +1 V, Ref = 0 V | 650 | 800 | 1000 | μA | Max | |
| | PD = Ref -1.7 V, Ref = V_{S+} | 650 | 800 | 1000 | μA | Max | |
| Turnon time delay (t_{ON}) | 50% of final value | 4 | | | μs | Typ | |
| Turnoff time delay (t_{OFF}) | 50% of final value | 3 | | | μs | Typ | |
| Input impedance | $f = 1\text{ MHz}$ | 6 | | | $\text{G}\Omega$ | Typ | |
| Output impedance | | 100 | | | $\text{k}\Omega$ | Typ | |

⁽¹⁾ For detailed information on the power-down circuit, see the *powerdown* section in the *Application Information* section of this data sheet.

TYPICAL CHARACTERISTICS

Table of Graphs (± 5 V)

| | | FIGURE |
|--|----------------------------|----------------|
| Small signal unity gain frequency response | | 1 |
| Small signal frequency response | | 2 |
| 0.1-dB gain flatness frequency response | | 3 |
| Large signal frequency response | | 4 |
| Slew rate | vs Output voltage | 5 |
| Harmonic distortion | vs Frequency | 6, 7, 8, 9 |
| Harmonic distortion | vs Output voltage swing | 10, 11, 12, 13 |
| Third order intermodulation distortion | vs Frequency | 14, 16 |
| Third order intercept point | vs Frequency | 15, 17 |
| Voltage and current noise | vs Frequency | 18 |
| Differential gain | vs Number of loads | 19 |
| Differential phase | vs Number of loads | 20 |
| Settling time | | 21 |
| Quiescent current | vs Supply voltage | 22 |
| Output voltage | Load resistance | 23 |
| Frequency response | vs Capacitive load | 24 |
| Open-loop gain and phase | vs Frequency | 25 |
| Open-loop gain | vs Case temperature | 26 |
| Rejection ratios | vs Frequency | 27 |
| Rejection ratios | vs Case temperature | 28 |
| Common-mode rejection ratio | vs Input common-mode range | 29 |
| Input offset voltage | vs Case temperature | 30 |
| Input bias and offset current | vs Case temperature | 31 |
| Small signal transient response | | 32 |
| Large signal transient response | | 33 |
| Overdrive recovery | | 34 |
| Closed-loop output impedance | vs Frequency | 35 |
| Power-down quiescent current | vs Supply voltage | 36 |
| Power-down output impedance | vs Frequency | 37 |
| Turnon and turnoff delay times | | 38 |

TYPICAL CHARACTERISTICS

Table of Graphs (5 V)

| | | FIGURE |
|--|----------------------------|----------------|
| Small signal unity gain frequency response | | 39 |
| Small signal frequency response | | 40 |
| 0.1-dB gain flatness frequency response | | 41 |
| Large signal frequency response | | 42 |
| Slew rate | vs Output voltage | 43 |
| Harmonic distortion | vs Frequency | 44, 45, 46, 47 |
| Harmonic distortion | vs Output voltage swing | 48, 49, 50, 51 |
| Third order intermodulation distortion | vs Frequency | 52, 54 |
| Third order intercept point | vs Frequency | 53, 55 |
| Voltage and current noise | vs Frequency | 56 |
| Settling time | | 57 |
| Quiescent current | vs Supply voltage | 58 |
| Output voltage | vs Load resistance | 59 |
| Frequency response | vs Capacitive load | 60 |
| Open-loop gain and phase | vs Frequency | 61 |
| Open-loop gain | vs Case temperature | 62 |
| Rejection ratios | vs Frequency | 63 |
| Rejection ratios | vs Case temperature | 64 |
| Common-mode rejection ratio | vs Input common-mode range | 65 |
| Input offset voltage | vs Case temperature | 66 |
| Input bias and offset current | vs Case temperature | 67 |
| Small signal transient response | | 68 |
| Large signal transient response | | 69 |
| Overdrive recovery | | 70 |
| Closed-loop output impedance | vs Frequency | 71 |
| Power-down quiescent current | vs Supply voltage | 72 |
| Power-down output impedance | vs Frequency | 73 |
| Turnon and turnoff delay times | | 74 |

TYPICAL CHARACTERISTICS (± 5 V GRAPHS)

SMALL SIGNAL UNITY GAIN
FREQUENCY RESPONSE

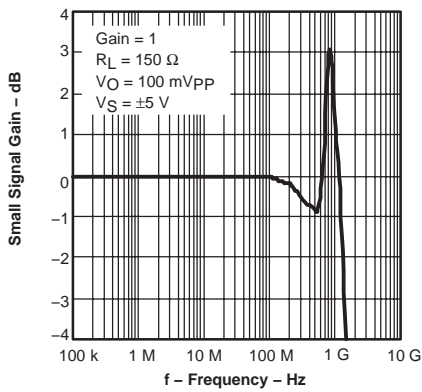

Figure 2

SMALL SIGNAL FREQUENCY RESPONSE

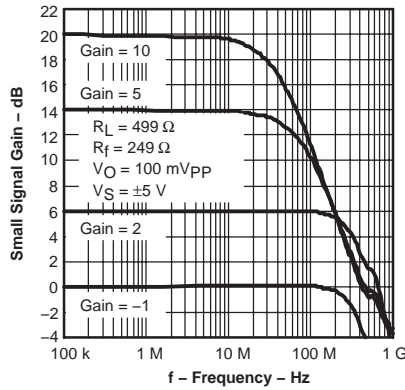

Figure 3

0.1 dB GAIN FLATNESS
FREQUENCY RESPONSE

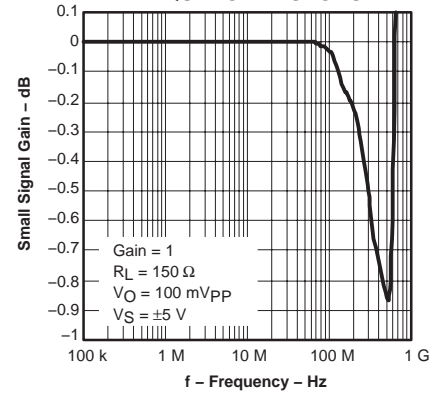

Figure 4

LARGE SIGNAL FREQUENCY RESPONSE

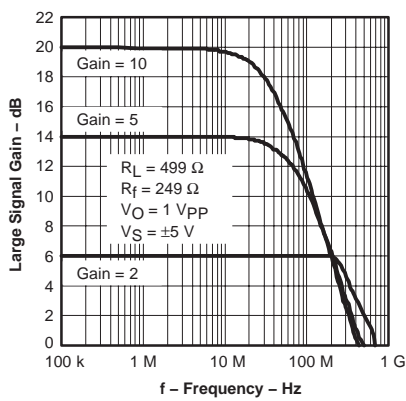

Figure 5

SLEW RATE
VS
OUTPUT VOLTAGE

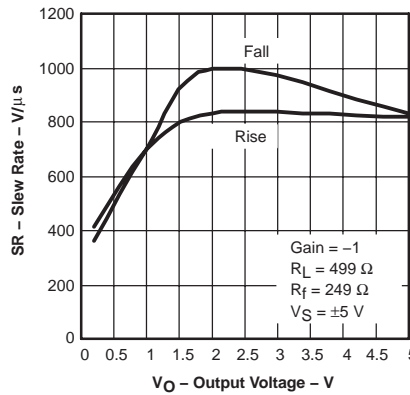

Figure 6

HARMONIC DISTORTION
VS
FREQUENCY

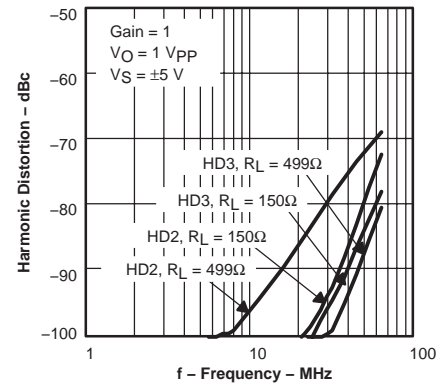

Figure 7

HARMONIC DISTORTION
VS
FREQUENCY

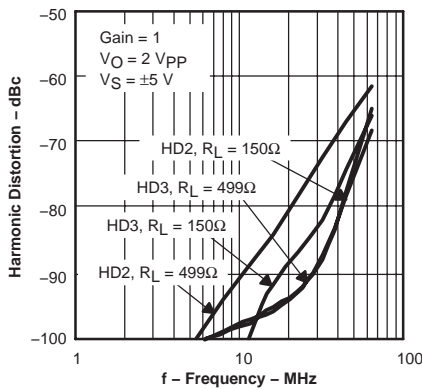

Figure 8

HARMONIC DISTORTION
VS
FREQUENCY

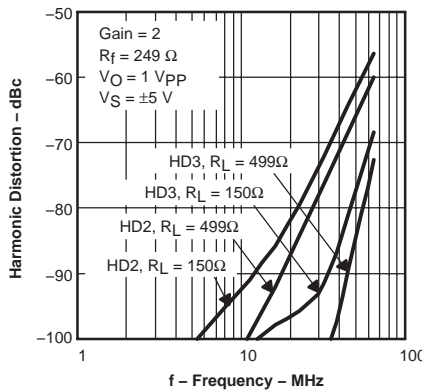

Figure 9

HARMONIC DISTORTION
VS
FREQUENCY

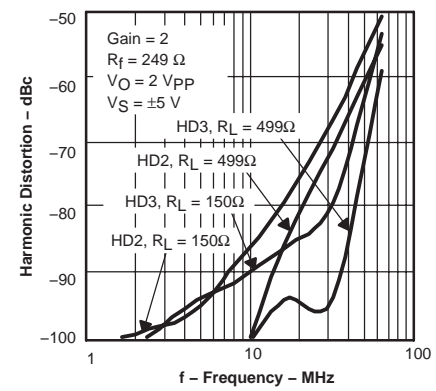

Figure 10

TYPICAL CHARACTERISTICS (± 5 V GRAPHS) (CONTINUED)

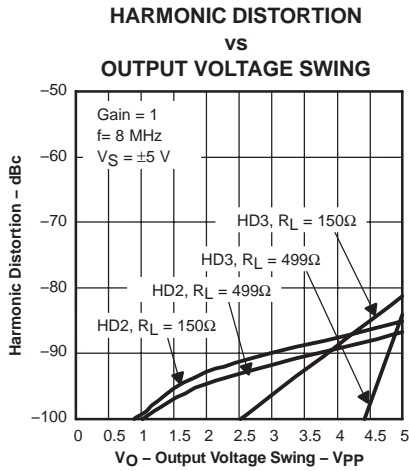

Figure 11

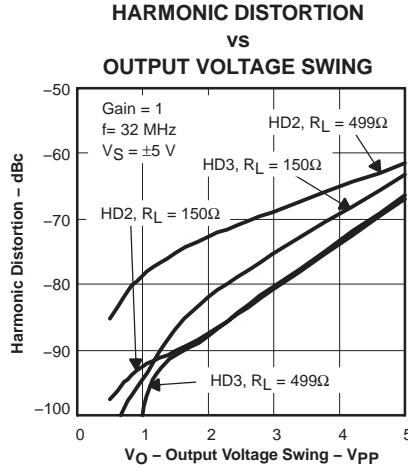

Figure 12

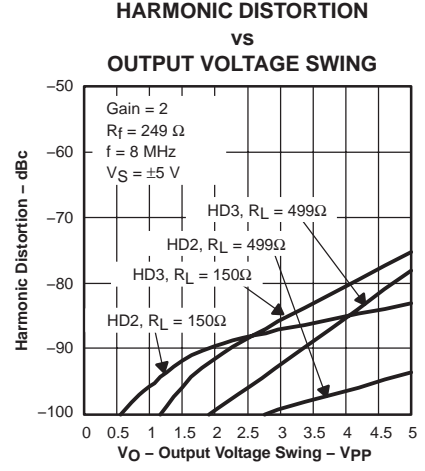

Figure 13

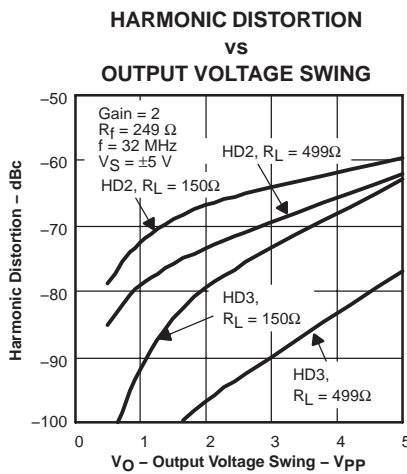

Figure 14

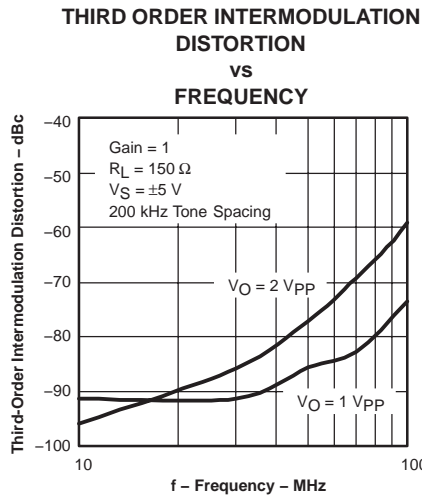

Figure 15

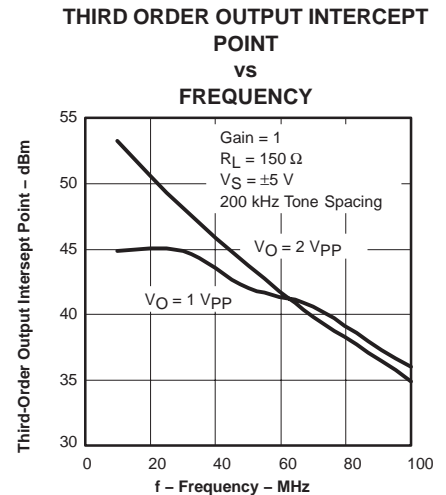

Figure 16

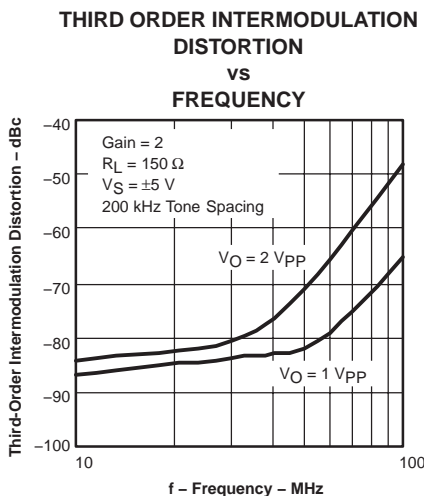

Figure 17

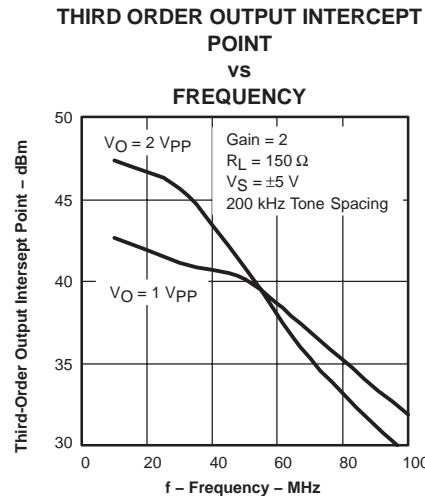

Figure 18

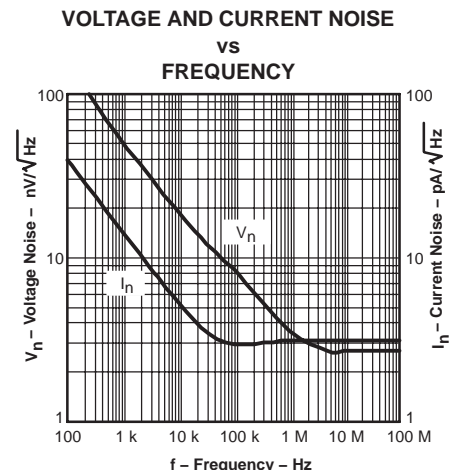

Figure 19

TYPICAL CHARACTERISTICS (± 5 V GRAPHS) (CONTINUED)

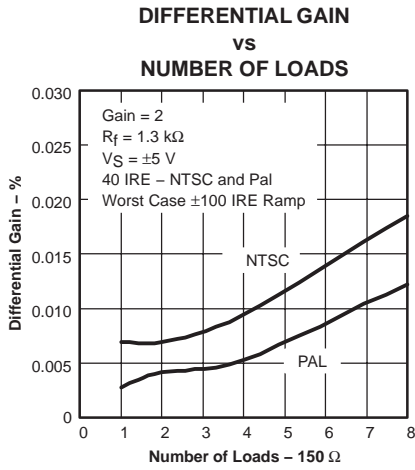

Figure 20

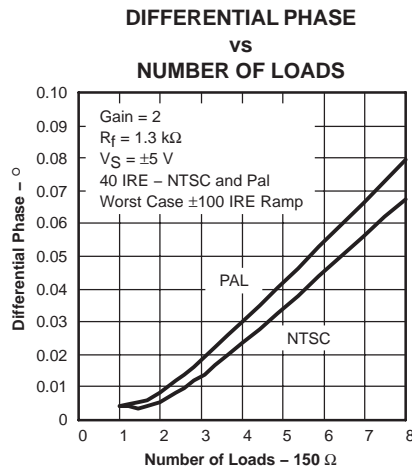

Figure 21

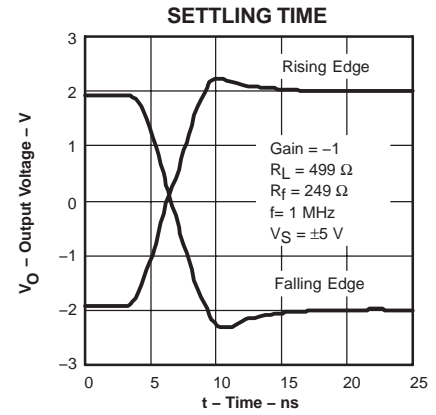

Figure 22

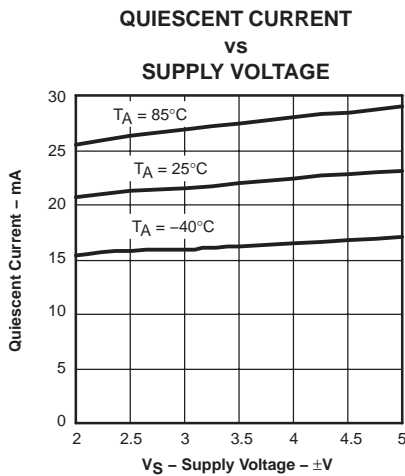

Figure 23

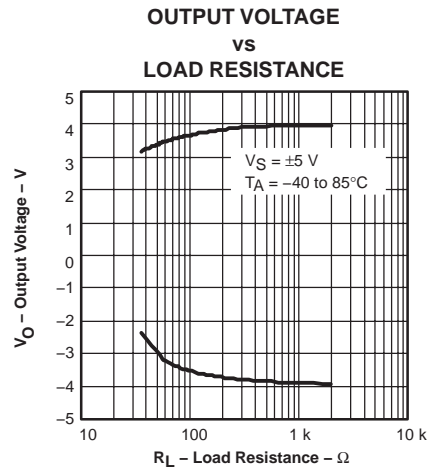

Figure 24

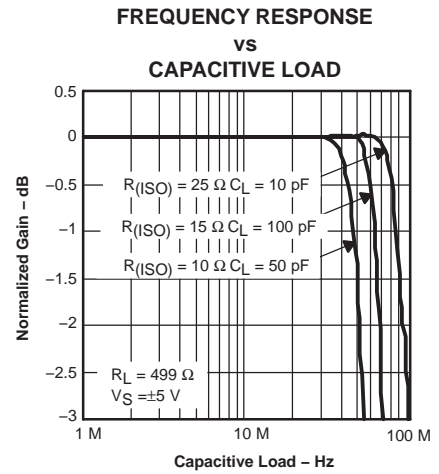

Figure 25

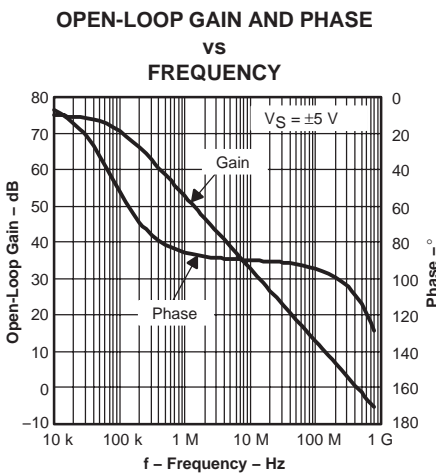

Figure 26

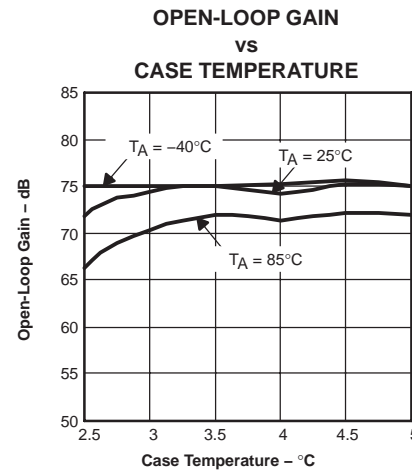

Figure 27

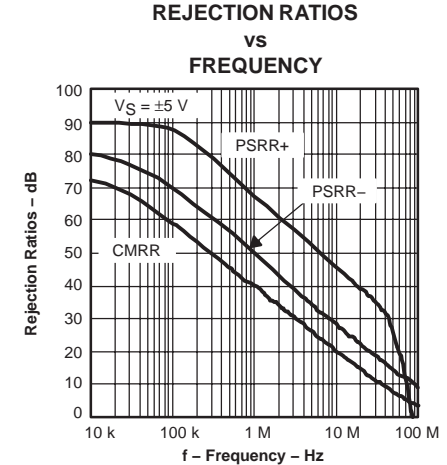

Figure 28

TYPICAL CHARACTERISTICS (± 5 V GRAPHS) (CONTINUED)

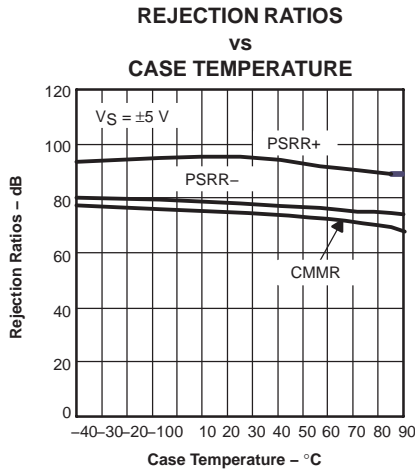

Figure 29

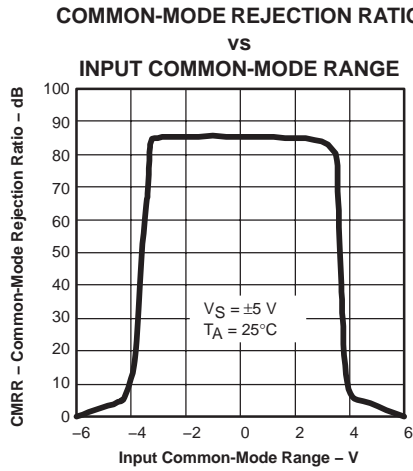

Figure 30

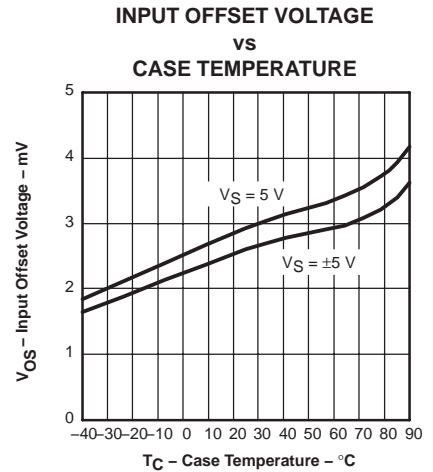

Figure 31

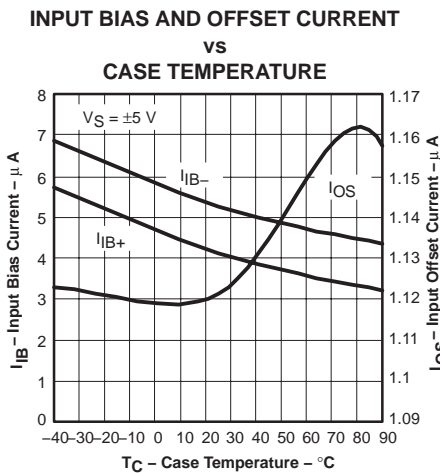

Figure 32

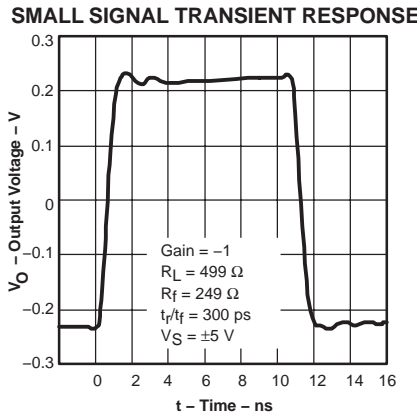

Figure 33

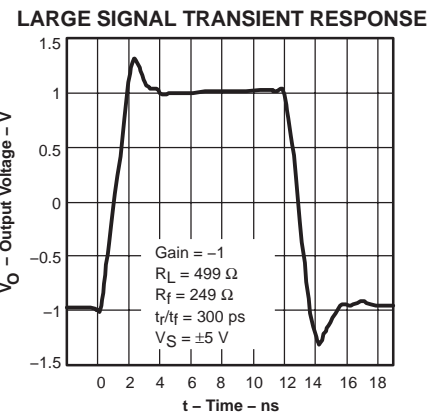

Figure 34

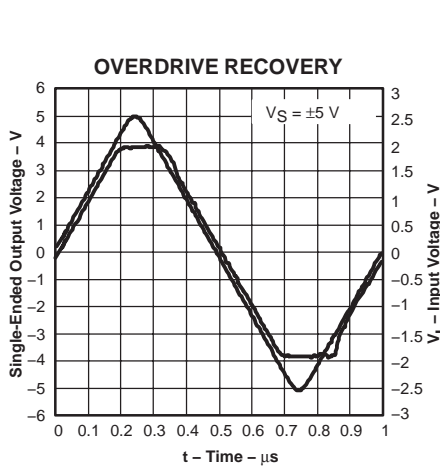

Figure 35

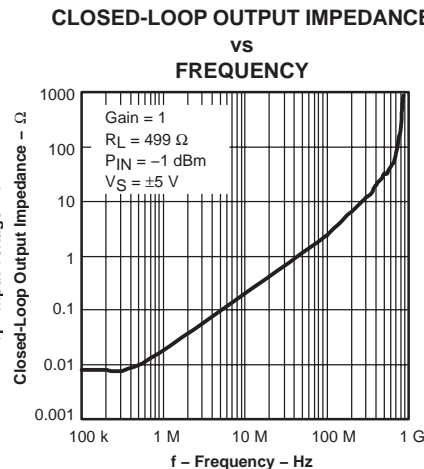

Figure 36

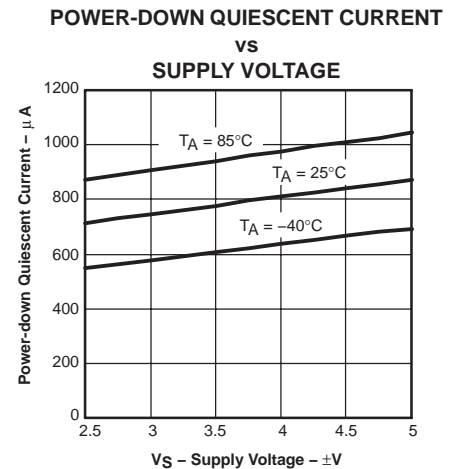

Figure 37

TYPICAL CHARACTERISTICS (± 5 V GRAPHS) (CONTINUED)

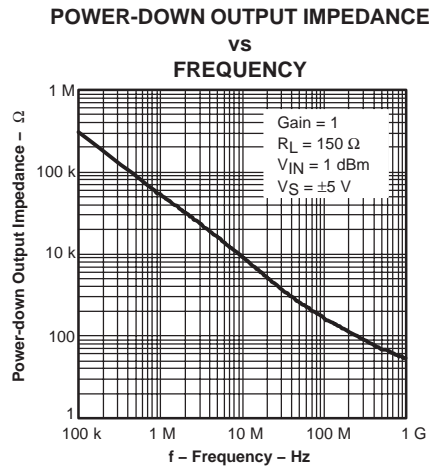

Figure 38

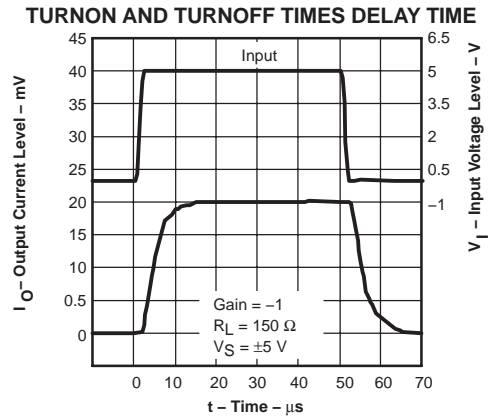

Figure 39

TYPICAL CHARACTERISTICS (5 V GRAPHS)

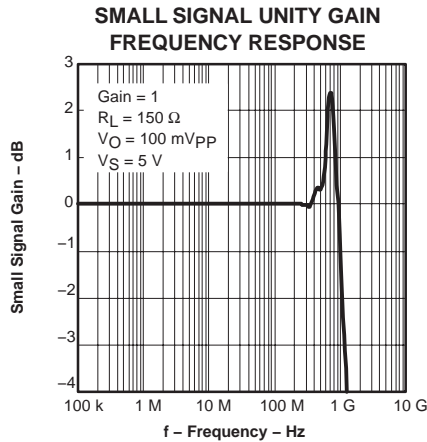

Figure 40

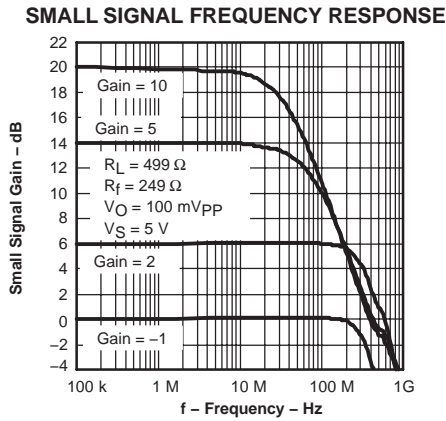

Figure 41

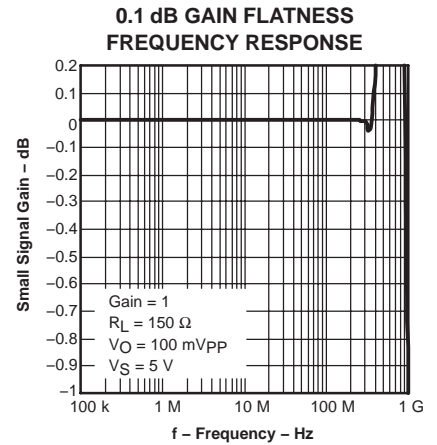

Figure 42

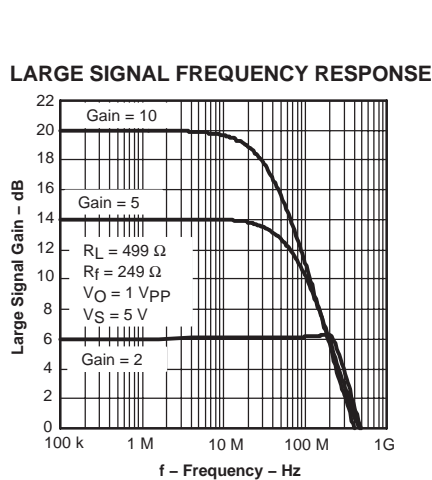

Figure 43

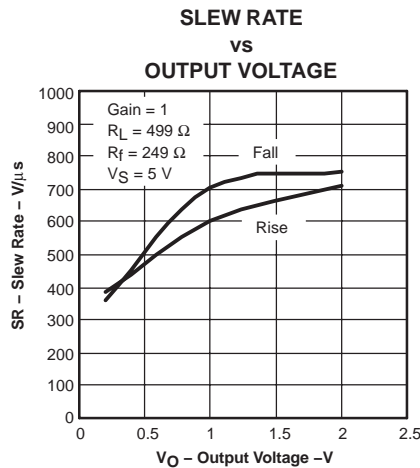

Figure 44

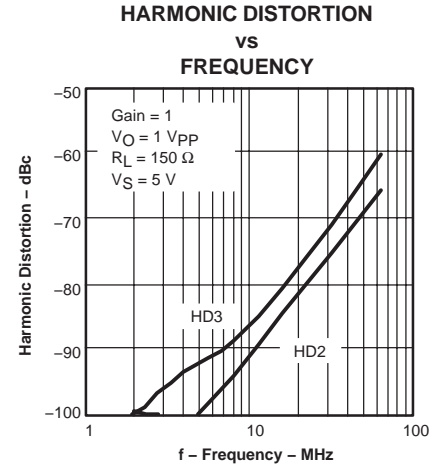

Figure 45

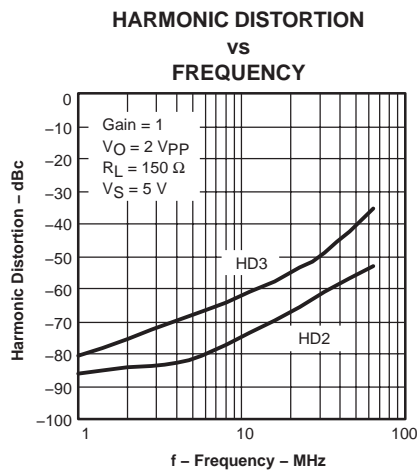

Figure 46

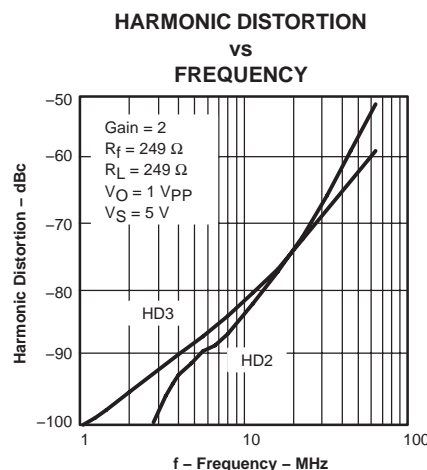

Figure 47

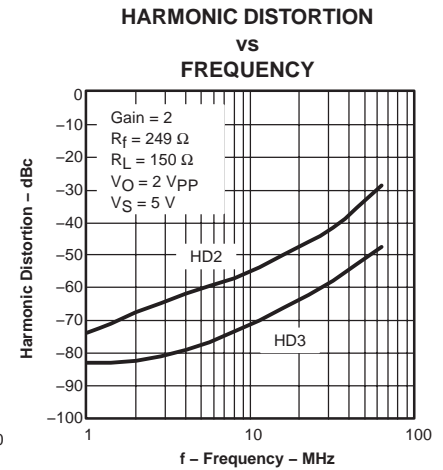

Figure 48

TYPICAL CHARACTERISTICS (5 V GRAPHS)

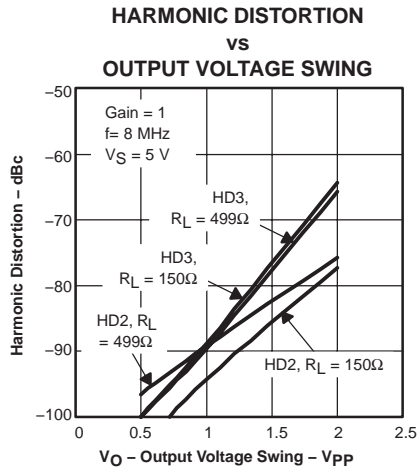

Figure 49

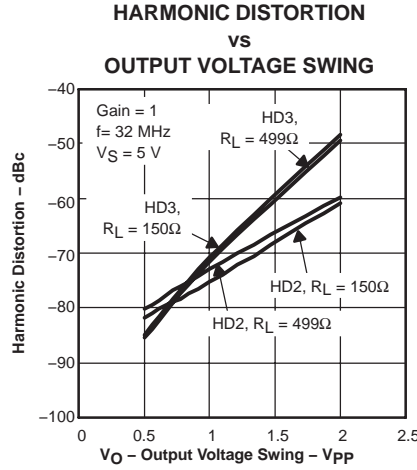

Figure 50

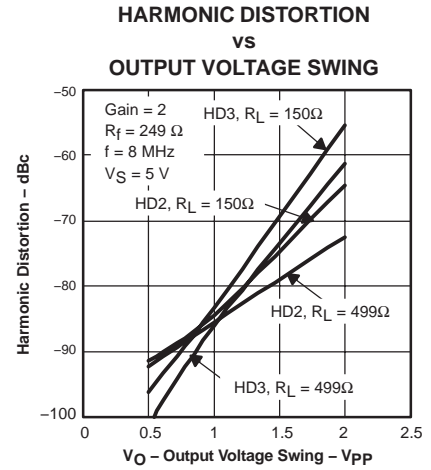

Figure 51

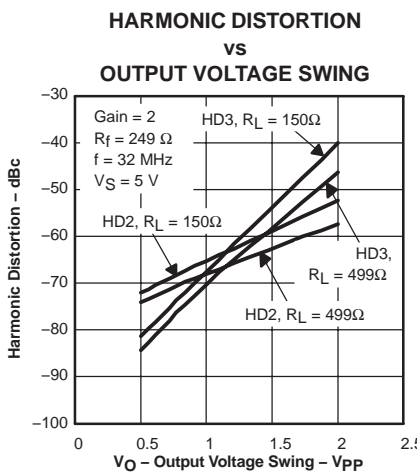

Figure 52

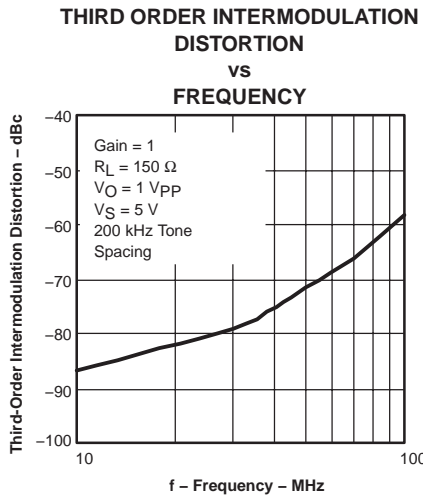

Figure 53

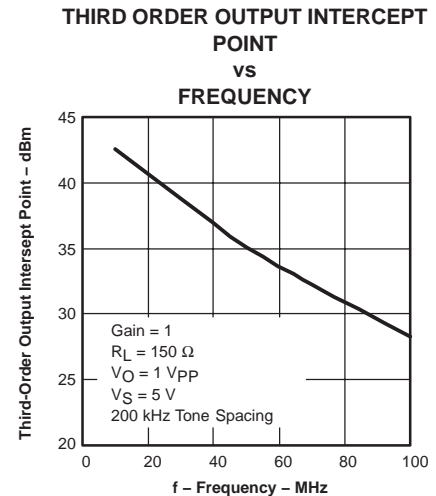

Figure 54

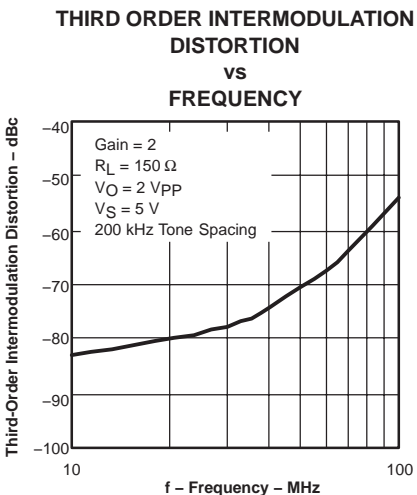

Figure 55

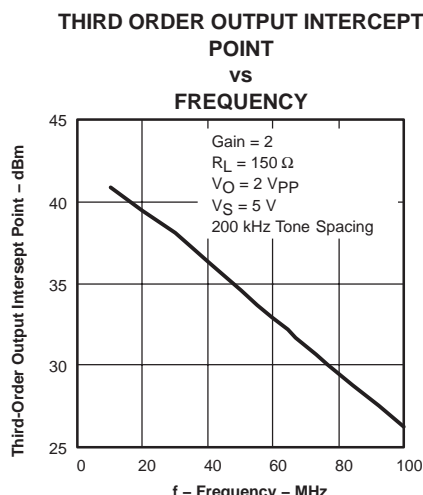

Figure 56

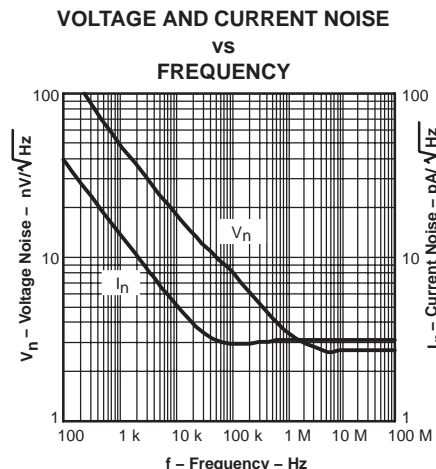

Figure 57

TYPICAL CHARACTERISTICS (5 V GRAPHS) (CONTINUED)

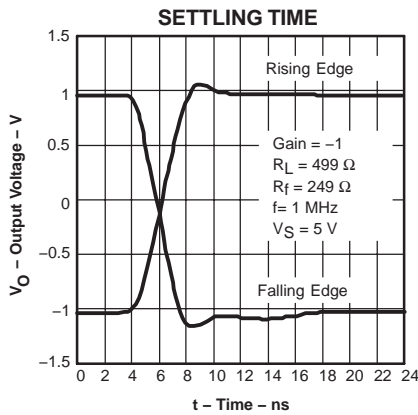

Figure 58

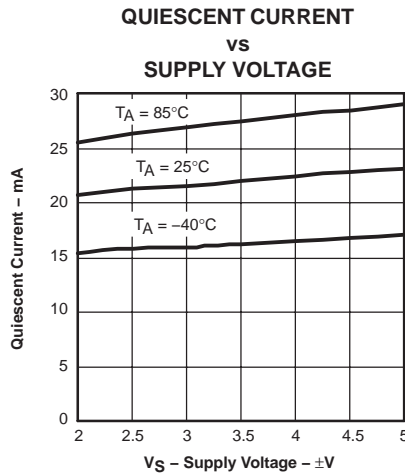

Figure 59

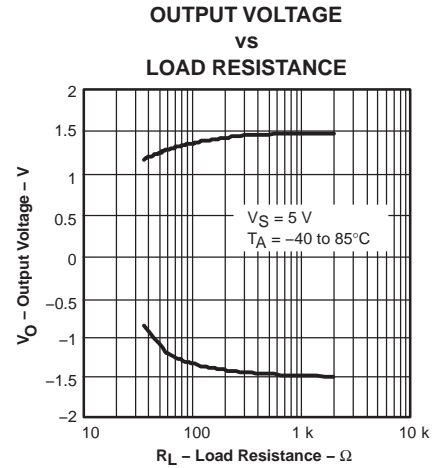

Figure 60

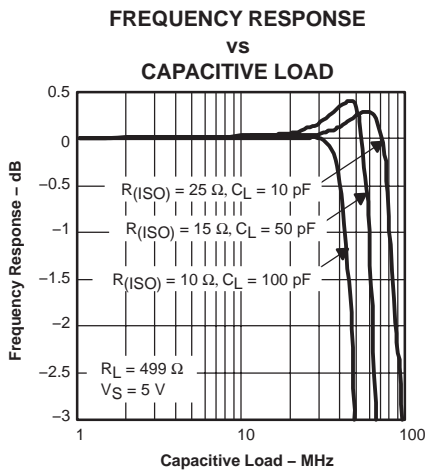

Figure 61

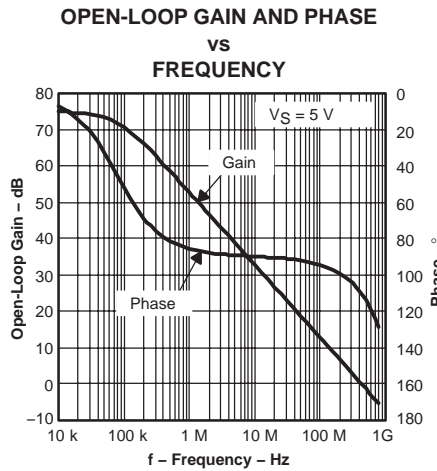

Figure 62

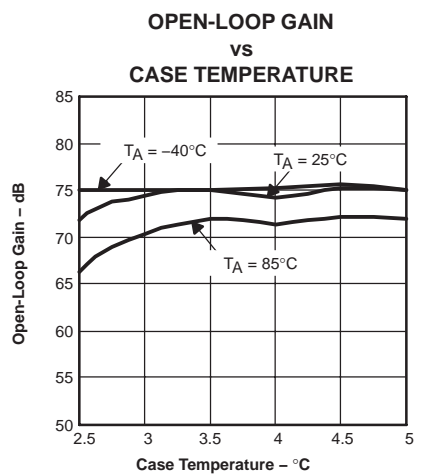

Figure 63

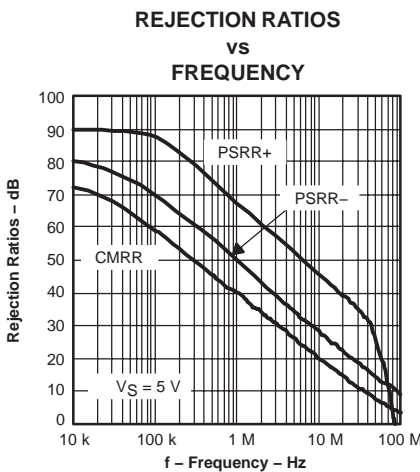

Figure 64

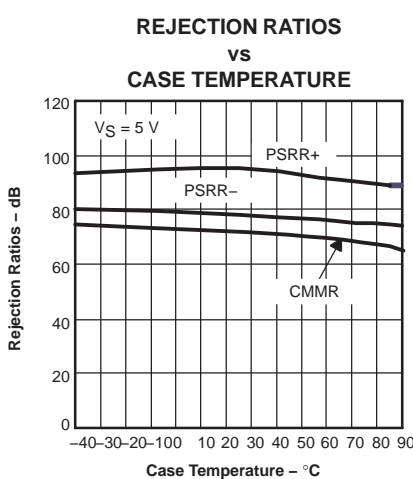

Figure 65

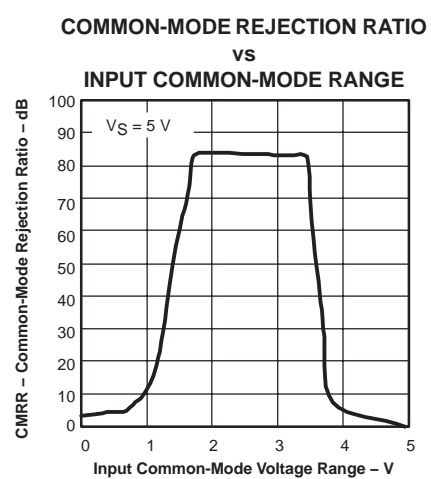

Figure 66

TYPICAL CHARACTERISTICS (5 V GRAPHS) (CONTINUED)

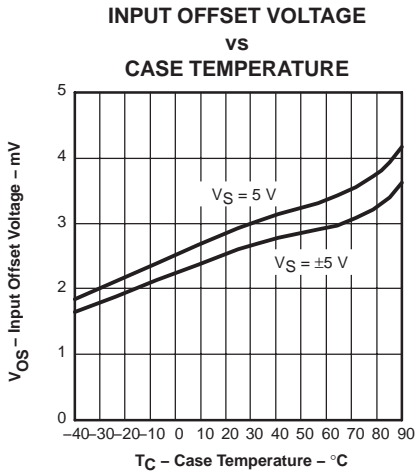

Figure 67

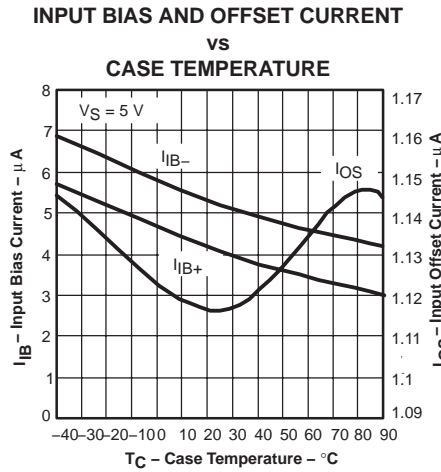

Figure 68

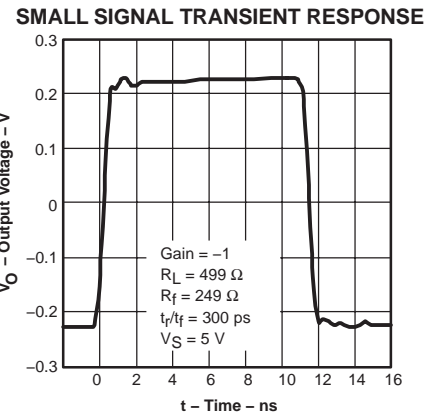

Figure 69

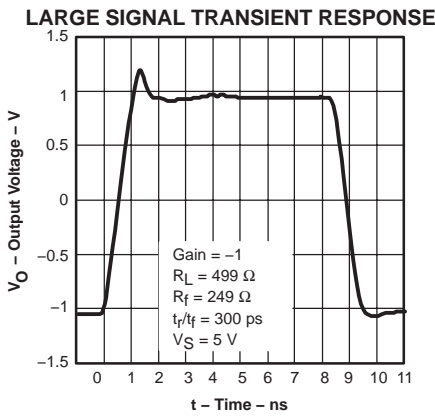

Figure 70

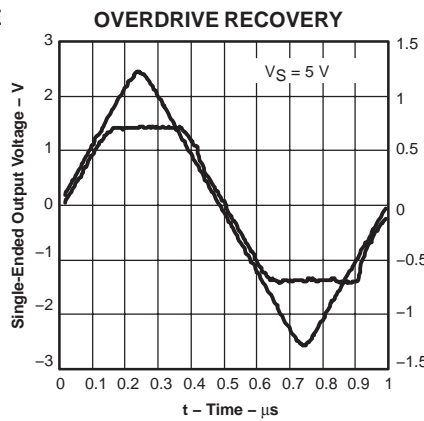

Figure 71

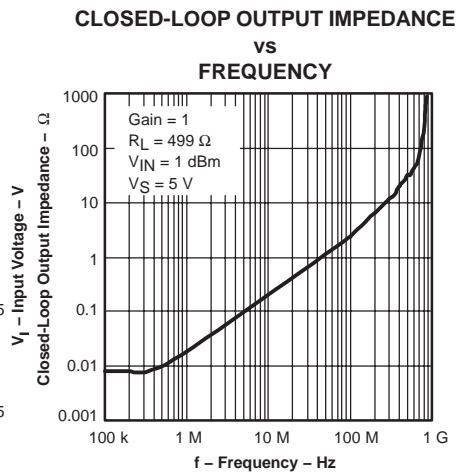

Figure 72

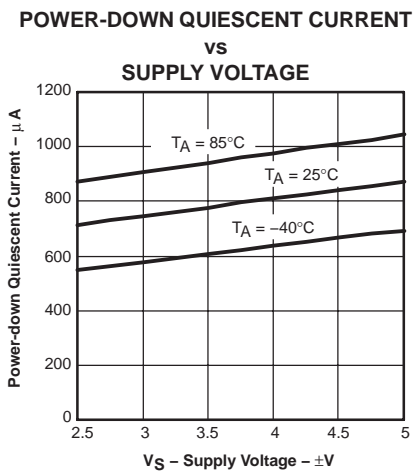

Figure 73

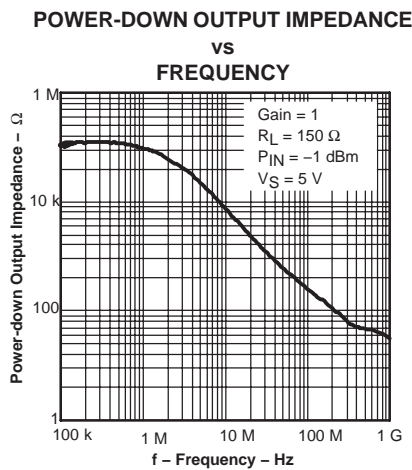

Figure 74

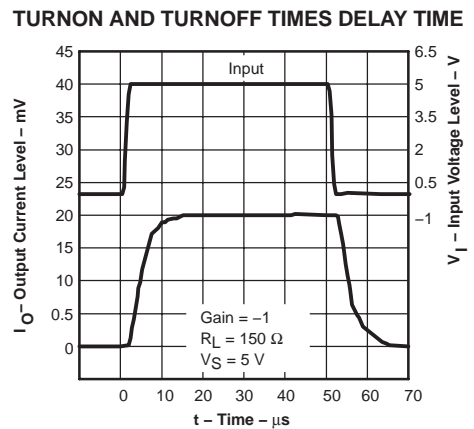

Figure 75

APPLICATION INFORMATION

HIGH-SPEED OPERATIONAL AMPLIFIERS

The THS4271 and the THS4275 operational amplifiers set new performance levels, combining low distortion, high slew rates, low noise, and a unity-gain bandwidth in excess of 1 GHz. To achieve the full performance of the amplifier, careful attention must be paid to printed-circuit board layout and component selection.

The THS4275 provides a power-down mode, providing the ability to save power when the amplifier is inactive. A reference pin is provided to allow the user the flexibility to control the threshold levels of the power-down control pin.

Applications Section Contents

- Wideband, Noninverting Operation
- Wideband, Inverting Gain Operation
- Single Supply Operation
- Saving Power With Power-Down Functionality and Setting Threshold Levels With the Reference Pin
- Power Supply Decoupling Techniques and Recommendations
- Using the THS4271 as a DAC Output Buffer
- Driving an ADC With the THS4271
- Active Filtering With the THS4271
- Building a Low-Noise Receiver With the THS4271
- Linearity: Definitions, Terminology, Circuit Techniques and Design Tradeoffs
- An Abbreviated Analysis of Noise in Amplifiers
- Driving Capacitive Loads
- Printed Circuit Board Layout Techniques for Optimal Performance
- Power Dissipation and Thermal Considerations
- Performance vs Package Options
- Evaluation Fixtures, Spice Models, and Applications Support
- Additional Reference Material
- Mechanical Package Drawings

WIDEBAND, NONINVERTING OPERATION

The THS4271 and the THS4275 are unity gain stable 1.4-GHz voltage feedback operational amplifiers, with and without power-down capability, designed to operate from a single 5-V to 15-V power supply.

Figure 76 is the noninverting gain configuration of 2 V/V used to demonstrate the typical performance curves. Most of the curves were characterized using signal sources with

50- Ω source impedance, and with measurement equipment presenting a 50- Ω load impedance. In Figure 76, the 49.9- Ω shunt resistor at the V_{IN} terminal matches the source impedance of the test generator. The total 499- Ω load at the output, combined with the 498- Ω total feedback network load, presents the THS4271 and THS4275 with an effective output load of 249 Ω for the circuit of Figure 76.

Voltage feedback amplifiers, unlike current feedback designs, can use a wide range of resistors values to set their gain with minimal impact on their stability and frequency response. Larger-valued resistors decrease the loading effect of the feedback network on the output of the amplifier, but this enhancement comes at the expense of additional noise and potentially lower bandwidth. Feedback resistor values between 249 Ω and 1 k Ω are recommended for most situations.

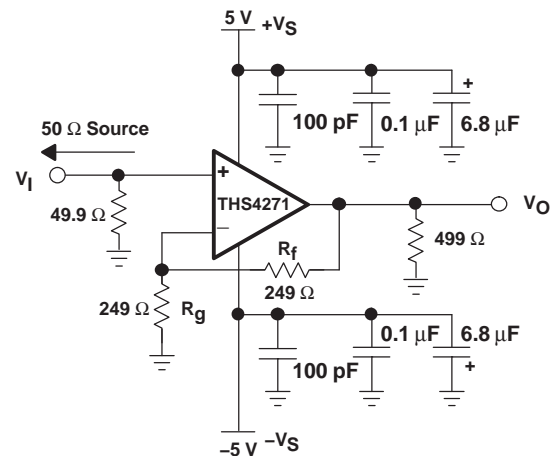

Figure 76. Wideband, Noninverting Gain Configuration

WIDEBAND, INVERTING GAIN OPERATION

Since the THS4271 and THS4275 are general-purpose, wideband voltage-feedback amplifiers, several familiar operational amplifier applications circuits are available to the designer. Figure 77 shows a typical inverting configuration where the input and output impedances and noise gain from Figure 76 are retained in an inverting circuit configuration. Inverting operation is one of the more common requirements and offers several performance benefits. The inverting configuration shows improved slew rates and distortion due to the pseudo-static voltage maintained on the inverting input.

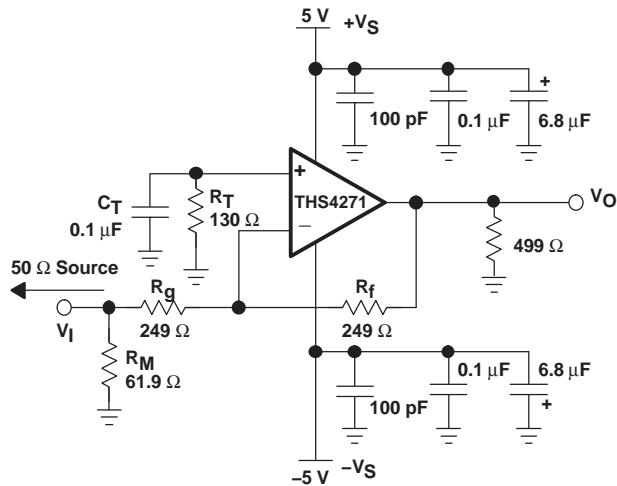

Figure 77. Wideband, Inverting Gain Configuration

In the inverting configuration, some key design considerations must be noted. One is that the gain resistor (R_g) becomes part of the signal channel input impedance. If the input impedance matching is desired (which is beneficial whenever the signal is coupled through a cable, twisted pair, long PC board trace, or other transmission line conductors), R_g may be set equal to the required termination value and R_f adjusted to give the desired gain. However, care must be taken when dealing with low inverting gains, as the resultant feedback resistor value can present a significant load to the amplifier output. For an inverting gain of 2, setting R_g to 49.9 Ω for input matching eliminates the need for R_M but requires a 100- Ω feedback resistor. This has an advantage of the noise gain becoming equal to 2 for a 50- Ω source impedance—the same as the noninverting circuit in Figure 76. However, the amplifier output now sees the 100- Ω feedback resistor in parallel with the external load. To eliminate this excessive loading, it is preferable to increase both R_g and R_f values, as shown in Figure 77, and then achieve the input matching impedance with a third resistor (R_M) to ground. The total input impedance becomes the parallel combination of R_g and R_M .

The next major consideration is that the signal source impedance becomes part of the noise gain equation and hence influences the bandwidth. For example, the R_M value combines in parallel with the external 50- Ω source impedance (at high frequencies), yielding an effective source impedance of $50 \Omega \parallel 61.9 \Omega = 27.7 \Omega$. This impedance is then added in series with R_g for calculating the noise gain. The result is 1.9 for Figure 77, as opposed to the 1.8 if R_M is eliminated. The bandwidth is lower for the gain of -2 circuit, Figure 77, ($NG=+1.9$) than for the gain of $+2$ circuit in Figure 76.

The last major consideration in inverting amplifier design is setting the bias current cancellation resistor on the noninverting input. If the resistance is set equal to the total dc resistance looking out of the inverting terminal, the output dc error, due to the input bias currents, is reduced to (input offset current) multiplied by R_f in Figure 77, the dc-source impedance looking out of the inverting terminal is $249 \Omega \parallel (249 \Omega + 27.7 \Omega) = 130 \Omega$. To reduce the additional high-frequency noise introduced by the resistor at the noninverting input, and power-supply feedback, R_T is bypassed with a capacitor to ground.

SINGLE SUPPLY OPERATION

The THS4271 is designed to operate from a single 5-V to 15-V power supply. When operating from a single power supply, care must be taken to ensure the input signal and amplifier are biased appropriately to allow for the maximum output voltage swing. The circuits shown in Figure 78 demonstrate methods to configure an amplifier in a manner conducive for single supply operation.

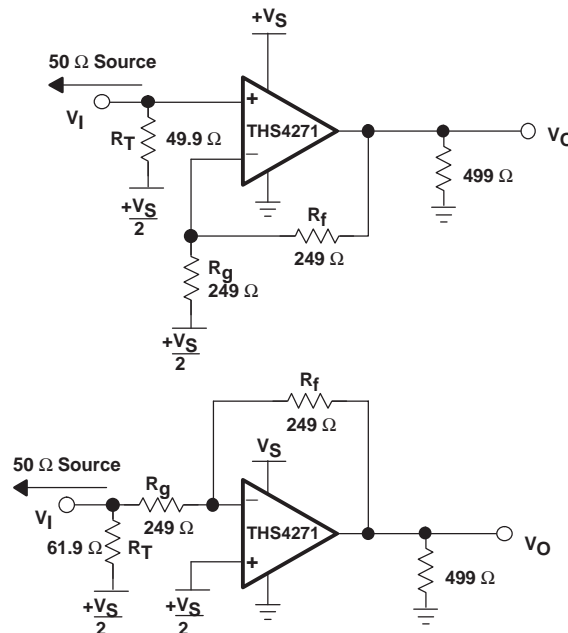

Figure 78. DC-Coupled Single Supply Operation

Saving Power With Power-Down Functionality and Setting Threshold Levels With the Reference Pin

The THS4275 features a power-down pin (\overline{PD}) which lowers the quiescent current from 22 mA down to 700 μ A, ideal for reducing system power.

The power-down pin of the amplifiers defaults to the positive supply voltage in the absence of an applied voltage, putting the amplifier in the power-on mode of operation. To turn off the amplifier in an effort to conserve power, the power-down pin can be driven towards the

negative rail. The threshold voltages for power-on and power-down are relative to the supply rails and given in the specification tables. Above the *Enable Threshold Voltage*, the device is on. Below the *Disable Threshold Voltage*, the device is off. Behavior in between these threshold voltages is not specified.

Note that this power-down functionality is just that; the amplifier consumes less power in power-down mode. The power-down mode is not intended to provide a high-impedance output. In other words, the power-down functionality is not intended to allow use as a 3-state bus driver. When in power-down mode, the impedance looking back into the output of the amplifier is dominated by the feedback and gain setting resistors, but the output impedance of the device itself varies depending on the voltage applied to the outputs.

The time delays associated with turning the device on and off are specified as the time it takes for the amplifier to reach 50% of the nominal quiescent current. The time delays are on the order of microseconds because the amplifier moves in and out of the linear mode of operation in these transitions.

Power-Down Reference Pin Operation

In addition to the power-down pin, the THS4275 also features a reference pin (REF) which allows the user to control the enable or disable power-down voltage levels applied to the \overline{PD} pin. Operation of the reference pin as it relates to the power-down pin is described below.

In most split-supply applications, the reference pin is connected to ground. In some cases, the user may want to connect it to the negative or positive supply rail. In either case, the user needs to be aware of the voltage level thresholds that apply to the power-down pin. The tables below show examples and illustrate the relationship between the reference voltage and the power-down thresholds.

| POWER-DOWN THRESHOLD VOLTAGE LEVELS (REF ≤ MIDRAIL) | | | |
|---|---------------------------|------------------|-------------------|
| SUPPLY VOLTAGE (V) | REFERENCE PIN VOLTAGE (V) | ENABLE LEVEL (V) | DISABLE LEVEL (V) |
| ±5 | GND | ≥ 1.8 | ≤ 1 |
| | -2.5 | ≥ -0.7 | ≤ -1.5 |
| | -5 | ≥ -3.2 | ≤ -4 |
| 5 | GND | ≥ 1.8 | ≤ 1 |
| | 1 | ≥ 2.8 | ≤ 2 |
| | 2.5 | ≥ 4.3 | ≤ 3.5 |

In the above table, the threshold levels are derived by the following equations:

$$\text{REF} + 1.8 \text{ V for enable}$$

$$\text{REF} + 1 \text{ V for disable}$$

Note that in order to maintain these threshold levels, the reference pin can be any voltage between V_{S-} or GND up to $V_{S/2}$ (midrail).

| POWER-DOWN THRESHOLD VOLTAGE LEVELS (REF > MIDRAIL) | | | |
|---|---------------------------|------------------|-------------------|
| SUPPLY VOLTAGE (V) | REFERENCE PIN VOLTAGE (V) | ENABLE LEVEL (V) | DISABLE LEVEL (V) |
| ±5 | Floating or 5 | ≥ 4 | ≤ 3.3 |
| | 2.5 | ≥ 1.5 | ≤ 0.8 |
| | 1 | ≥ 0 | ≤ -0.7 |
| 5 | Floating or 5 | ≥ 3.3 | ≤ 3.3 |
| | 4 | ≥ 3 | ≤ 2.3 |
| | 3.5 | ≥ 2.5 | ≤ 1.8 |

In the above table, the threshold levels are derived by the following equations:

$$\text{REF} - 1 \text{ V for enable}$$

$$\text{REF} - 1.7 \text{ V for disable}$$

Note that in order to maintain these threshold levels, the reference pin can be any voltage between $(V_{S+}/2) + 1 \text{ V}$ to V_{S+} .

The recommended mode of operation is to tie the reference pin to midrail, thus setting the threshold levels to midrail +1 V and midrail +1.8 V.

| NO. OF CHANNELS | PACKAGES |
|-----------------|--------------------------------------|
| Single (8 pin) | THS4275D, THS4275DGN, and THS4275DRB |

Power Supply Decoupling Techniques and Recommendations

Power supply decoupling is a critical aspect of any high-performance amplifier design process. Careful decoupling provides higher quality ac performance (most notably improved distortion performance). The following guidelines ensure the highest level of performance.

1. Place decoupling capacitors as close to the power supply inputs as possible, with the goal of minimizing the inductance of the path from ground to the power supply.
2. Placement priority should put the smallest valued capacitors closest to the device.
3. Use of solid power and ground planes is recommended to reduce the inductance along power supply return current paths, with the exception of the areas underneath the input and output pins.
4. Recommended values for power supply decoupling include a bulk decoupling capacitor (6.8 to 22 μF), a mid-range decoupling capacitor (0.1 μF) and a high frequency decoupling capacitor (1000 pF) for each supply. A 100-pF capacitor can be used across the supplies as well for extremely high frequency return currents, but often is not required.

APPLICATION CIRCUITS

Driving an Analog-to-Digital Converter With the THS4271

The THS4271 can be used to drive high-performance analog-to-digital converters. Two example circuits are presented below.

The first circuit uses a wideband transformer to convert a single-ended input signal into a differential signal. The differential signal is then amplified and filtered by two THS4271 amplifiers. This circuit provides low intermodulation distortion, suppressed even-order distortion, 14 dB of voltage gain, a 50-Ω input impedance, and a single-pole filter at 100 MHz. For applications without signal content at dc, this method of driving ADCs can be useful. Where dc information content is required, the THS4500 family of fully differential amplifiers may be applicable.

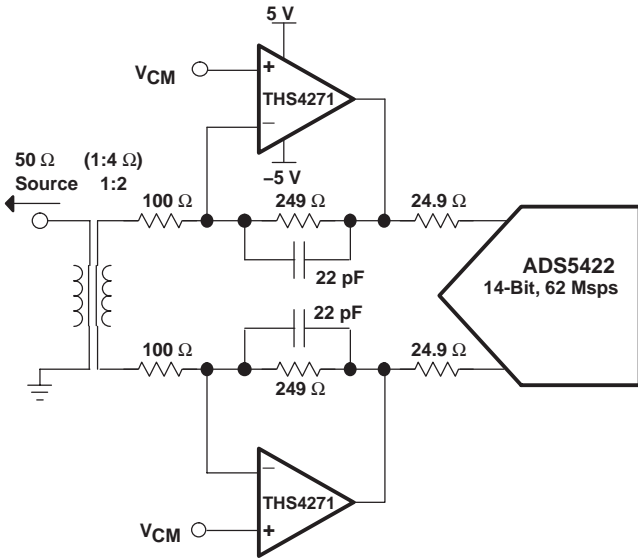
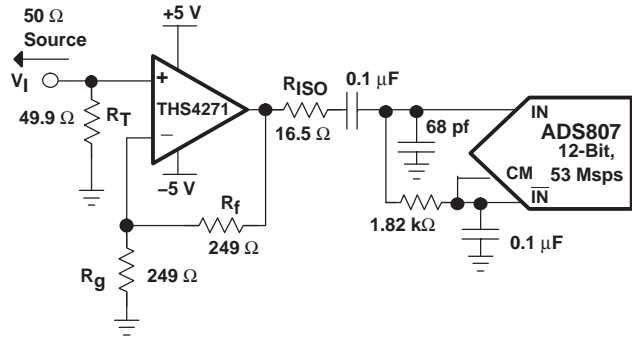

Figure 79. A Linear, Low Noise, High Gain ADC Preamplifier

The second circuit depicts single-ended ADC drive. While not recommended for optimum performance using converters with differential inputs, satisfactory performance can sometimes be achieved with single-ended input drive. An example circuit is shown here for reference.



NOTE: For the best performance, high-speed ADCs should be driven differentially. See the THS4500 family of devices for more information.

Figure 80. Driving an ADC With a Single-Ended Input

Using the THS4271 as a DAC Output Buffer

Two example circuits are presented here showing the THS4271 buffering the output of a digital-to-analog converter. The first circuit performs a differential to single-ended conversion with the THS4271 configured as a difference amplifier. The difference amplifier can double as the termination mechanism for the DAC outputs as well.

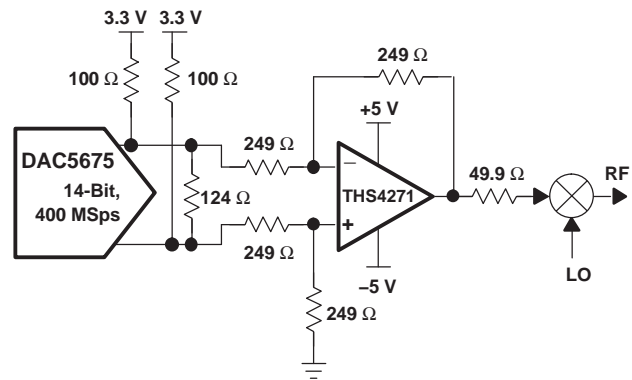

Figure 81. Differential to Single-Ended Conversion of a High-Speed DAC Output

For cases where a differential signaling path is desirable, a pair of THS4271 amplifiers can be used as output buffers. The circuit depicts differential drive into a mixer's IF inputs, coupled with additional signal gain and filtering.

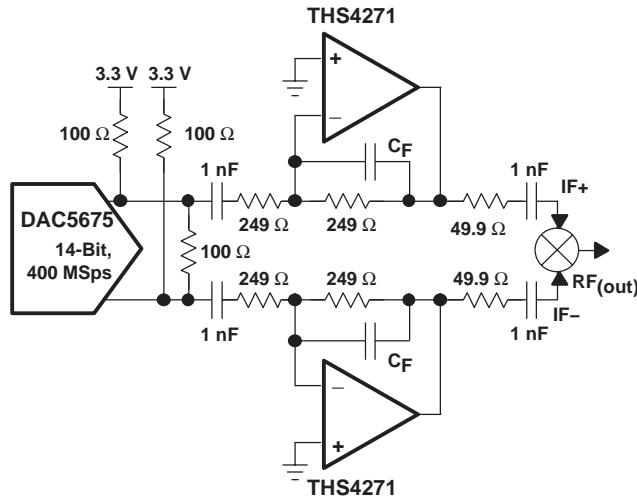

Figure 82. Differential Mixer Drive Circuit Using the DAC5675 and the THS4271

Active Filtering With the THS4271

High-frequency active filtering with the THS4271 is achievable due to the amplifier's high slew-rate, wide bandwidth, and voltage feedback architecture. Several options are available for high-pass, low-pass, bandpass, and bandstop filters of varying orders. A simple two-pole low pass filter is presented here as an example, with two poles at 100 MHz.

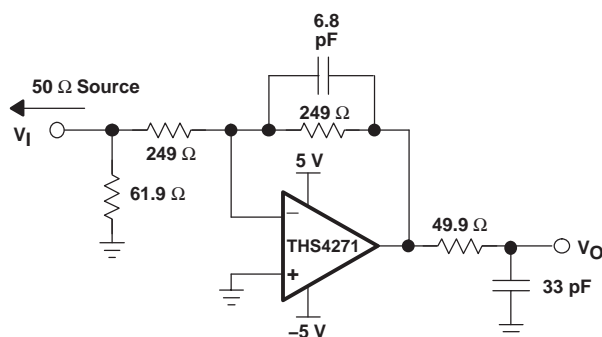

Figure 83. A Two-Pole Active Filter With Two Poles Between 90 MHz and 100 MHz

A Low-Noise Receiver With the THS4271

A combination of two THS4271 amplifiers can create a high-speed, low-distortion, low-noise differential receiver circuit as depicted in Figure 84. With both amplifiers operating in the noninverting mode of operation, the circuit presents a high load impedance to the source. The designer has the option of controlling the impedance through termination resistors if a matched termination impedance is desired.

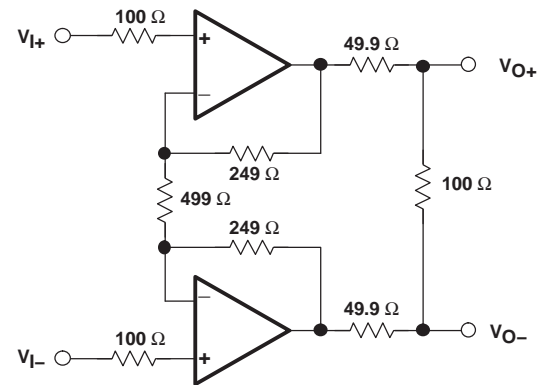

Figure 84. A High Input Impedance, Low Noise, Differential Receiver

A modification on this circuit to include a difference amplifier turns this circuit into a high-speed instrumentation amplifier, as shown in Figure 85.

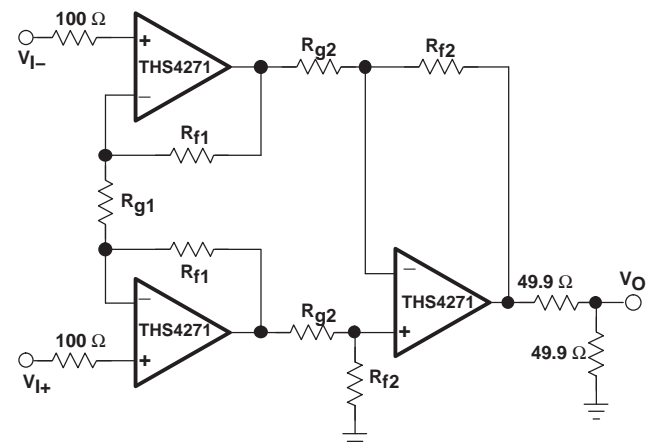

Figure 85. A High-Speed Instrumentation Amplifier

$$V_o = \frac{1}{2} \left(1 + \frac{2R_{f1}}{R_{g1}} \right) (V_{i+} - V_{i-}) \left(\frac{R_{f2}}{R_{g2}} \right) \quad (1)$$

THEORY AND GUIDELINES

Distortion Performance

The THS4271 provides excellent distortion performance into a 150-Ω load. Relative to alternative solutions, it provides exceptional performance into lighter loads, as well as exceptional performance on a single 5-V supply. Generally, until the fundamental signal reaches high frequency or power levels, the 2nd harmonic dominates the total harmonic distortion with a negligible 3rd harmonic component. Focusing then on the 2nd harmonic, increasing the load impedance improves distortion

directly. The total load includes the feedback network; in the noninverting configuration (see Figure 76) this is the sum of R_f and R_g , while in the inverting configuration (see Figure 77), only R_f needs to be included in parallel with the actual load.

LINEARITY: DEFINITIONS, TERMINOLOGY, CIRCUIT TECHNIQUES, AND DESIGN TRADEOFFS

The THS4271 features excellent distortion performance for monolithic operational amplifiers. This section focuses on the fundamentals of distortion, circuit techniques for reducing nonlinearity, and methods for equating distortion of operational amplifiers to desired linearity specifications in RF receiver chains.

Amplifiers are generally thought of as *linear* devices. The output of an amplifier is a linearly scaled version of the input signal applied to it. However, amplifier transfer functions are nonlinear. Minimizing amplifier nonlinearity is a primary design goal in many applications.

Intercept points are specifications long used as key design criteria in the RF communications world as a metric for the intermodulation distortion performance of a device in the signal chain (e.g., amplifiers, mixers, etc.). Use of the intercept point, rather than strictly the intermodulation distortion, allows simpler system-level calculations. Intercept points, like noise figures, can be easily cascaded back and forth through a signal chain to determine the overall receiver chain's intermodulation distortion performance. The relationship between intermodulation distortion and intercept point is depicted in Figure 86 and Figure 87.

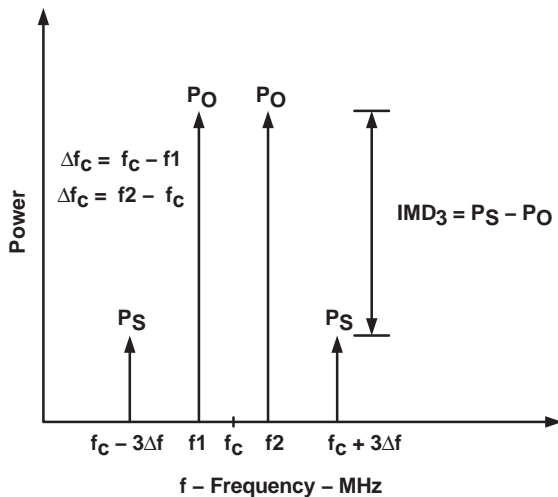

Figure 86

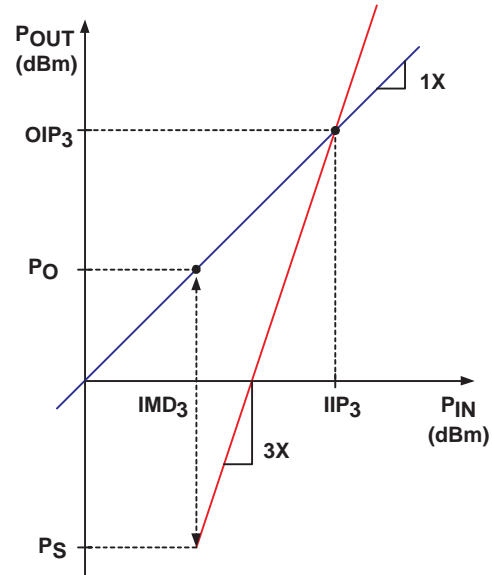

Figure 87

Due to the intercept point's ease of use in system level calculations for receiver chains, it has become the specification of choice for guiding distortion-related design decisions. Traditionally, these systems use primarily class-A, single-ended RF amplifiers as gain blocks. These RF amplifiers are typically designed to operate in a 50- Ω environment. Giving intercept points in dBm, implies an associated impedance (50 Ω).

However, with an operational amplifier, the output does not require termination as an RF amplifier would. Because closed-loop amplifiers deliver signals to their outputs regardless of the impedance present, it is important to comprehend this when evaluating the intercept point of an operational amplifier. The THS4271 yields optimum distortion performance when loaded with 150 Ω to 1 k Ω , which is similar to the input impedance of an analog-to-digital converter over its input frequency band.

As a result, terminating the input of the ADC to 50 Ω can actually be detrimental to systems performance.

The discontinuity between open-loop, class-A amplifiers and closed-loop, class-AB amplifiers becomes apparent when comparing the intercept points of the two types of devices. Equations 1 and 2 gives the definition of an intercept point, relative to the intermodulation distortion.

$$OIP_3 = P_O + \left(\frac{|IMD_3|}{2} \right) \text{ where} \quad (2)$$

$$P_O = 10 \log \left(\frac{V_P^2}{2R_L \times 0.001} \right) \quad (3)$$

NOTE: P_O is the output power of a single tone, R_L is the load resistance, and V_P is the peak voltage for a single tone.

NOISE ANALYSIS

High slew rate, unity gain stable, voltage-feedback operational amplifiers usually achieve their slew rate at the expense of a higher input noise voltage. The 3-nV/ $\sqrt{\text{Hz}}$ input voltage noise for the THS4271 and THS4275 is, however, much lower than comparable amplifiers. The input-referred voltage noise, and the two input-referred current noise terms (3 pA/ $\sqrt{\text{Hz}}$), combine to give low output noise under a wide variety of operating conditions. Figure 88 shows the amplifier noise analysis model with all the noise terms included. In this model, all noise terms are taken to be noise voltage or current density terms in either nV/ $\sqrt{\text{Hz}}$ or pA/ $\sqrt{\text{Hz}}$.

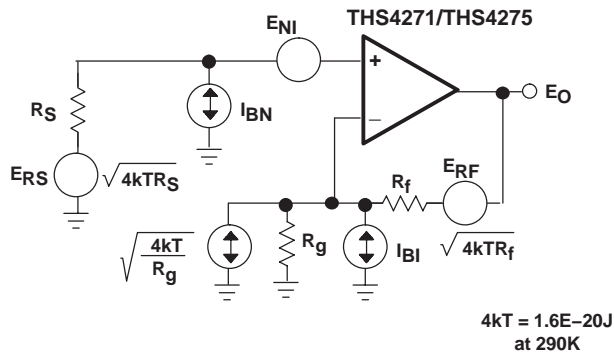

Figure 88. Noise Analysis Model

The total output shot noise voltage can be computed as the square of all square output noise voltage contributors. Equation 3 shows the general form for the output noise voltage using the terms shown in Figure 88:

$$E_O = \sqrt{\left(E_{NI}^2 + (I_{BN}R_S)^2 + 4kTR_S\right)NG^2 + (I_{BI}R_f)^2 + 4kTR_f} \quad (4)$$

Dividing this expression by the noise gain ($NG=(1+R_f/R_g)$) gives the equivalent input-referred spot noise voltage at the noninverting input, as shown in Equation 4:

$$E_O = \sqrt{E_{NI}^2 + (I_{BN}R_S)^2 + 4kTR_S + \left(\frac{I_{BI}R_f}{NG}\right)^2 + \frac{4kTR_f}{NG}} \quad (5)$$

Evaluation of these two equations for the circuit and component values shown in Figure 76 gives a total output spot noise voltage of 12.2 nV/ $\sqrt{\text{Hz}}$ and a total equivalent input spot noise voltage of 6.2 nV/ $\sqrt{\text{Hz}}$. This includes the noise added by the resistors. This total input-referred spot noise voltage is not much higher than the 3 nV/ $\sqrt{\text{Hz}}$ specification for the amplifier voltage noise alone.

Driving Capacitive Loads

One of the most demanding, and yet common, load conditions for an op amp is capacitive loading. Often, the capacitive load is the input of an A/D converter, including additional external capacitance, which may be recommended to improve A/D linearity. A high-speed, high open-loop gain amplifier like the THS4271 can be susceptible to decreased stability and closed-loop response peaking when a capacitive load is placed directly on the output pin. When the amplifier's open-loop output resistance is considered, this capacitive load introduces an additional pole in the signal path that can decrease the phase margin. When the primary considerations are frequency response flatness, pulse response fidelity, or distortion, the simplest and most effective solution is to isolate the capacitive load from the feedback loop by inserting a series isolation resistor between the amplifier output and the capacitive load. This does not eliminate the pole from the loop response, but rather shifts it and adds a zero at a higher frequency. The additional zero acts to cancel the phase lag from the capacitive load pole, thus increasing the phase margin and improving stability.

The *Typical Characteristics* show the recommended isolation resistor vs capacitive load and the resulting frequency response at the load. Parasitic capacitive loads greater than 2 pF can begin to degrade the performance of the THS4271. Long PC board traces, unmatched cables, and connections to multiple devices can easily cause this value to be exceeded. Always consider this effect carefully, and add the recommended series resistor as close as possible to the THS4271 output pin (see Board Layout Guidelines).

The criterion for setting this $R_{(ISO)}$ resistor is a maximum bandwidth, flat frequency response at the load. For a gain of +2, the frequency response at the output pin is already slightly peaked without the capacitive load, requiring relatively high values of $R_{(ISO)}$ to flatten the response at the load. Increasing the noise gain also reduces the peaking.

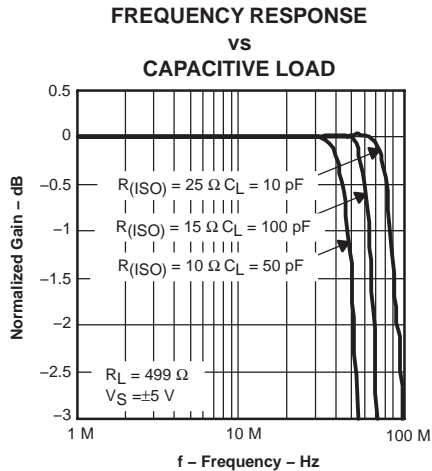

Figure 89. Isolation Resistor Diagram

BOARD LAYOUT

Achieving optimum performance with a high frequency amplifier like the THS4271 requires careful attention to board layout parasitics and external component types.

Recommendations that optimize performance include:

1. **Minimize parasitic capacitance to any ac ground for all of the signal I/O pins.** Parasitic capacitance on the output and inverting input pins can cause instability: on the noninverting input, it can react with the source impedance to cause unintentional band limiting. To reduce unwanted capacitance, a window around the signal I/O pins should be opened in all of the ground and power planes around those pins. Otherwise, ground and power planes should be unbroken elsewhere on the board.
2. **Minimize the distance (< 0.25") from the power supply pins to high frequency 0.1-μF decoupling capacitors.** At the device pins, the ground and power plane layout should not be in close proximity to the signal I/O pins. Avoid narrow power and ground traces to minimize inductance between the pins and the decoupling capacitors. The power supply connections should always be decoupled with these capacitors. Larger (2.2 μF to 6.8 μF) decoupling capacitors, effective at lower frequency, should also be used on the main supply pins. These may be placed somewhat farther from the device and may be shared among several devices in the same area of the PC board.
3. **Careful selection and placement of external components preserves the high frequency performance of the THS4271.** Resistors should be a low reactance type. Surface-mount resistors work best and allow a tighter overall layout. Metal-film and carbon composition, axially-leaded resistors can also provide good high frequency performance. Again,
4. **Connections to other wideband devices on the board may be made with short direct traces or through onboard transmission lines.** For short connections, consider the trace and the input to the next device as a lumped capacitive load. Relatively wide traces (50 mils to 100 mils) should be used, preferably with ground and power planes opened up around them. Estimate the total capacitive load and set R_{ISO} from the plot of recommended R_{ISO} vs capacitive load. Low parasitic capacitive loads (<4 pF) may not need an R_{ISO} , since the THS4271 is nominally compensated to operate with a 2-pF parasitic load. Higher parasitic capacitive loads without an R_{ISO} are allowed as the signal gain increases (increasing the unloaded phase margin). If a long trace is required, and the 6-dB signal loss intrinsic to a doubly-terminated transmission line is acceptable, implement a matched impedance transmission line using microstrip or stripline techniques (consult an ECL design handbook for microstrip and stripline layout techniques). A 50-Ω environment is normally not necessary onboard, and in fact, a higher impedance environment improves distortion as shown in the distortion versus load plots. With a characteristic board trace impedance defined based on board material and trace dimensions, a matching series resistor into the trace from the output of the THS4271 is used as well as a terminating shunt resistor at the input of the destination device. Remember also that the terminating impedance is the

parallel combination of the shunt resistor and the input impedance of the destination device: this total effective impedance should be set to match the trace impedance. If the 6-dB attenuation of a doubly terminated transmission line is unacceptable, a long trace can be series-terminated at the source end only. Treat the trace as a capacitive load in this case and set the series resistor value as shown in the plot of $R_{(ISO)}$ vs capacitive load. This does not preserve signal integrity or a doubly-terminated line. If the input impedance of the destination device is low, there is some signal attenuation due to the voltage divider formed by the series output into the terminating impedance.

5. **Socketing a high speed part like the THS4271 is not recommended.** The additional lead length and pin-to-pin capacitance introduced by the socket can create a troublesome parasitic network, which can make it almost impossible to achieve a smooth, stable frequency response. The best results are obtained by soldering the THS4271 onto the board.

PowerPAD™ DESIGN CONSIDERATIONS

The THS4271 and THS4275 are available in a thermally-enhanced PowerPAD family of packages. These packages are constructed using a downset leadframe upon which the die is mounted [see Figure 90(a) and Figure 90(b)]. This arrangement results in the lead frame being exposed as a thermal pad on the underside of the package [see Figure 90(c)]. Because this thermal pad has direct thermal contact with the die, excellent thermal performance can be achieved by providing a good thermal path away from the thermal pad.

The PowerPAD package allows both assembly and thermal management in one manufacturing operation.

During the surface-mount solder operation (when the leads are being soldered), the thermal pad can also be soldered to a copper area underneath the package. Through the use of thermal paths within this copper area, heat can be conducted away from the package into either a ground plane or other heat dissipating device.

The PowerPAD package represents a breakthrough in combining the small area and ease of assembly of surface mount with the heretofore awkward mechanical methods of heatsinking.

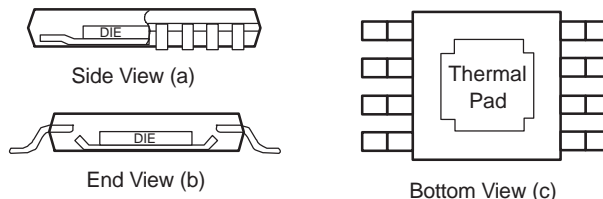

Figure 90. Views of Thermally Enhanced Package

Although there are many ways to properly heatsink the PowerPAD package, the following steps illustrate the recommended approach.

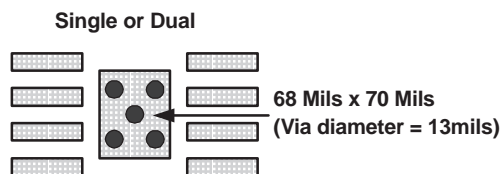

Figure 91. PowerPAD PCB Etch and Via Pattern

PowerPAD PCB LAYOUT CONSIDERATIONS

1. Prepare the PCB with a top side etch pattern as shown in Figure 91. There should be etch for the leads as well as etch for the thermal pad.
2. Place five holes in the area of the thermal pad. The holes should be 13 mils in diameter. Keep the holes small so that solder wicking through the holes is not a problem during reflow.
3. Additional vias may be placed anywhere along the thermal plane outside of the thermal pad area. They help dissipate the heat generated by the THS4271 and THS4275 IC. These additional vias may be larger than the 13-mil diameter vias directly under the thermal pad. They can be larger because they are not in the thermal pad area to be soldered, so that wicking is not a problem.
4. Connect all holes to the internal ground plane.
5. When connecting these holes to the ground plane, **do not** use the typical web or spoke via connection methodology. Web connections have a high thermal resistance connection that is useful for slowing the heat transfer during soldering operations. This resistance makes the soldering of vias that have plane connections easier. In this application, however, low thermal resistance is desired for the most efficient heat transfer. Therefore, the holes under the THS4271 and THS4275 PowerPAD package should make their connection to the internal ground plane, with a complete connection around the entire circumference of the plated-through hole.

6. The top-side solder mask should leave the terminals of the package and the thermal pad area with its five holes exposed. The bottom-side solder mask should cover the five holes of the thermal pad area. This prevents solder from being pulled away from the thermal pad area during the reflow process.
7. Apply solder paste to the exposed thermal pad area and all of the IC terminals.
8. With these preparatory steps in place, the IC is simply placed in position and run through the solder reflow operation as any standard surface-mount component. This results in a part that is properly installed.

For a given θ_{JA} , the maximum power dissipation is shown in Figure 92 and is calculated by the equation 5:

$$P_D = \frac{T_{max} - T_A}{\theta_{JA}} \quad (6)$$

where:

- P_D = Maximum power dissipation of THS4271 (W)
- T_{MAX} = Absolute maximum junction temperature (150°C)
- T_A = Free-ambient temperature (°C)
- $\theta_{JA} = \theta_{JC} + \theta_{CA}$
- θ_{JC} = Thermal coefficient from junction to the case
- θ_{CA} = Thermal coefficient from the case to ambient air (°C/W).

The next consideration is the package constraints. The two sources of heat within an amplifier are quiescent power and output power. The designer should never forget about the quiescent heat generated within the device, especially multi-amplifier devices. Because these devices have linear output stages (Class AB), most of the heat dissipation is at low output voltages with high output currents.

The other key factor when dealing with power dissipation is how the devices are mounted on the PCB. The PowerPAD devices are extremely useful for heat dissipation. But, the device should always be soldered to a copper plane to fully use the heat dissipation properties of the PowerPAD. The SOIC package, on the other hand, is highly dependent on how it is mounted on the PCB. As more trace and copper area is placed around the device, θ_{JA} decreases and the heat dissipation capability increases. For a single package, the sum of the RMS output currents and voltages should be used to choose the proper package.

THERMAL ANALYSIS

The THS4271 device does not incorporate automatic thermal shutoff protection, so the designer must take care to ensure that the design does not violate the absolute

maximum junction temperature of the device. Failure may result if the absolute maximum junction temperature of 150°C is exceeded.

The thermal characteristics of the device are dictated by the package and the PC board. Maximum power dissipation for a given package can be calculated using the following formula.

$$P_{Dmax} = \frac{T_{max} - T_A}{\theta_{JA}} \quad (7)$$

where:

- P_{Dmax} is the maximum power dissipation in the amplifier (W).
- T_{max} is the absolute maximum junction temperature (°C).
- T_A is the ambient temperature (°C).
- $\theta_{JA} = \theta_{JC} + \theta_{CA}$
- θ_{JC} is the thermal coefficient from the silicon junctions to the case (°C/W).
- θ_{CA} is the thermal coefficient from the case to ambient air (°C/W).

For systems where heat dissipation is more critical, the THS4271 is offered in an 8-pin MSOP with PowerPAD. The thermal coefficient for the MSOP PowerPAD package is substantially improved over the traditional SOIC. Maximum power dissipation levels are depicted in the graph for the two packages. The data for the DGN package assumes a board layout that follows the PowerPAD layout guidelines referenced above and detailed in the PowerPAD application notes in the *Additional Reference Material* section at the end of the data sheet.

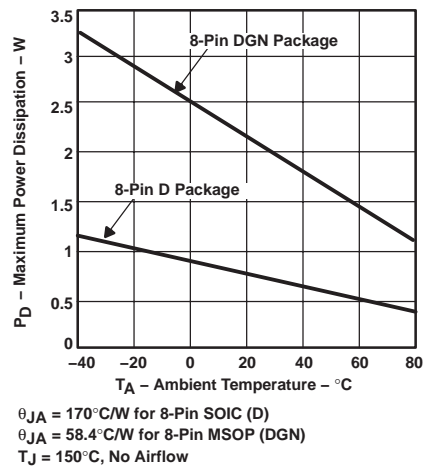

Figure 92. Maximum Power Dissipation vs Ambient Temperature

When determining whether or not the device satisfies the maximum power dissipation requirement, it is important to consider not only quiescent power dissipation, but also dynamic power dissipation. Often maximum power is difficult to quantify because the signal pattern is inconsistent, but an estimate of the RMS power dissipation can provide visibility into a possible problem.

DESIGN TOOLS

Performance vs Package Options

The THS4271 and THS4275 are offered in different package options. However, performance may be limited due to package parasitics and lead inductance in some packages. In order to achieve maximum performance of the THS4271 and THS4275, Texas Instruments recommends using the leadless MSOP (DRB) or MSOP (DGN) packages, in addition to proper high-speed PCB layout. Figure 93 shows the unity gain frequency response of the THS4271 using the leadless MSOP, MSOP, and SOIC package for comparison. Using the THS4271 and THS4275 in a unity gain with the SOIC package may result in the device becoming unstable. In higher gain configurations, this effect is mitigated by the reduced bandwidth. As such, the SOIC is suitable for application with gains equal to or higher than +2 V/V or (–1 V/V).

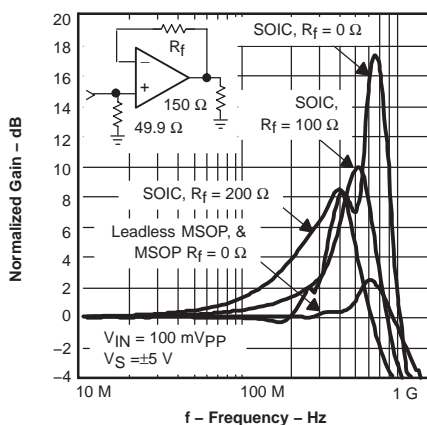

Figure 93. Effects of Unity Gain Frequency Response for Differential Packages

Evaluation Fixtures, Spice Models, and Applications Support

Texas Instruments is committed to providing its customers with the highest quality of applications support. To support this goal, evaluation boards have been developed for the THS4271 operational amplifier. Three evaluation boards are available: one THS4271 and one THS4275, both are configurable for different gains and a third for a gain of +1 (THS4271 only). These boards are easy to use, allowing for straightforward evaluation of the device. These evaluation boards can be ordered through the Texas Instruments web site, www.ti.com, or through your local Texas Instruments sales representative. Schematics for the evaluation boards are shown below.

The THS4271/THS4275 EVM board shown in Figure 97 through Figure 100 is designed to accommodate different gain configurations. Its default component values are set to give a gain of two. The EVM can be configured in a gain of +1; however, it is strongly not recommended. Evaluating the THS4271/THS4275 in a gain of one using this EVM may cause the part to become unstable. The stability of the device can be controlled by adding a large resistor in the feedback path, the performance is sacrificed. Figure 94 shows the small signal frequency response of the THS4271 with different feedback resistors in the feedback path. Figure 95 is the small frequency response of the THS4271 using the gain of 1 EVM.

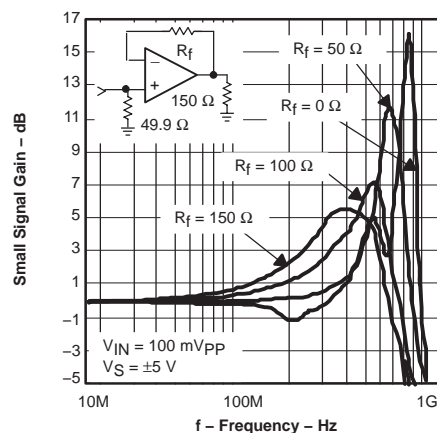

Figure 94. Frequency Response vs Feedback Resistor Using the EDGE #6439527 EVM

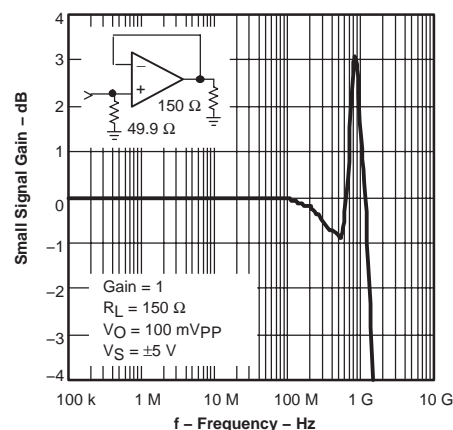

Figure 95. Frequency Response Using the EDGE # 6443547 G = +1 EVM

The peaking in the frequency response is due to the lead inductance in the feedback path. Each pad and trace on a PCB has an inductance associated with it, which in conjunction with the inductance associated with the package may cause peaking in the frequency response, causing the device to become unstable.

In order to achieve the maximum performance of the device, PCB layout is critical. Texas Instruments has developed an EVM for the evaluation of the THS4271 in a gain of one. The EVM is shown in Figure 102 through Figure 105. This EVM is designed to minimize peaking in the unity gain configuration.

Minimizing the inductance in the feedback path is critical for reducing the peaking of the frequency response in unity gain. The recommended maximum inductance allowed in the feedback path is 4 nH. This can be calculated by using Equation 8.

$$L(\text{nH}) = K\ell \left[\ln \frac{2\ell}{W + T} + 0.223 \frac{W + T}{\ell} + 0.5 \right] \quad (8)$$

where:

W = Width of trace in inches.

ℓ = Length of the trace in inches.

T = Thickness of the trace in inches.

K = 5.08 for dimensions in inches and K = 2 for dimensions in cm.

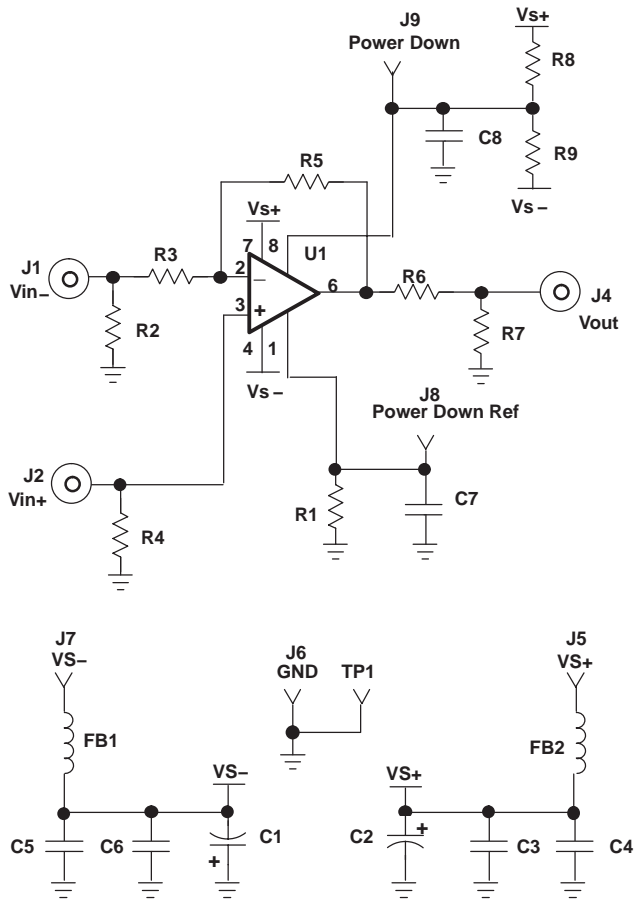

Figure 96. THS4271/THS4275 EVM Circuit Configuration

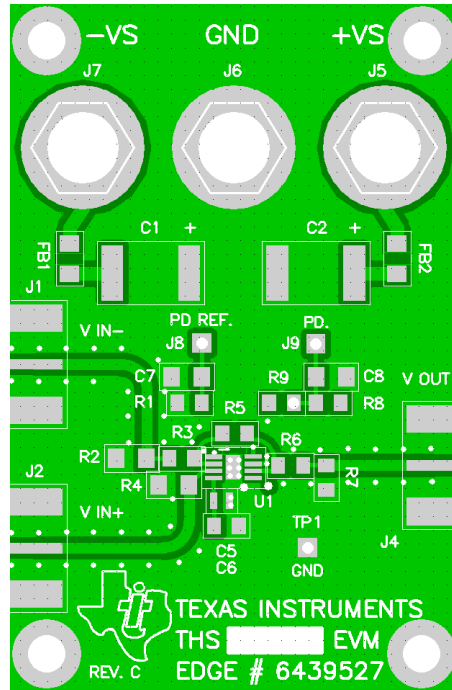

Figure 97. THS4271/THS4275 EVM Board Layout (Top Layer)

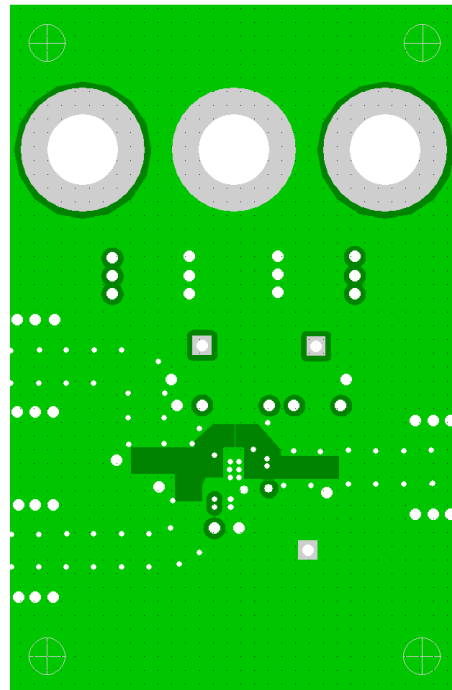

Figure 98. THS4271/THS4275 EVM Board Layout (Second Layer, Ground)

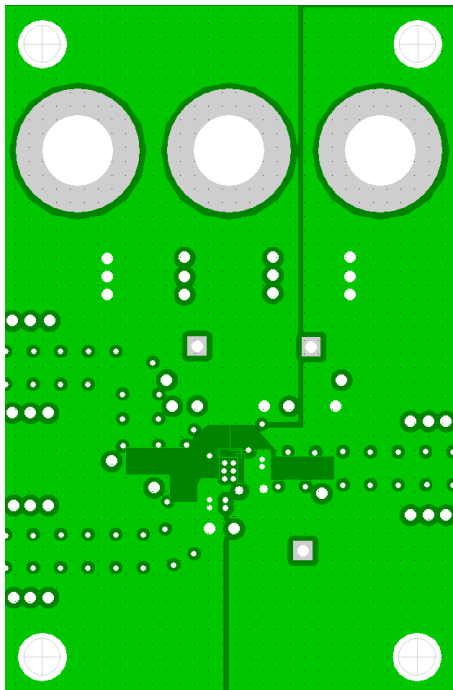

Figure 99. THS4271/THS4275 EVM Board Layout (Third Layer, Power)

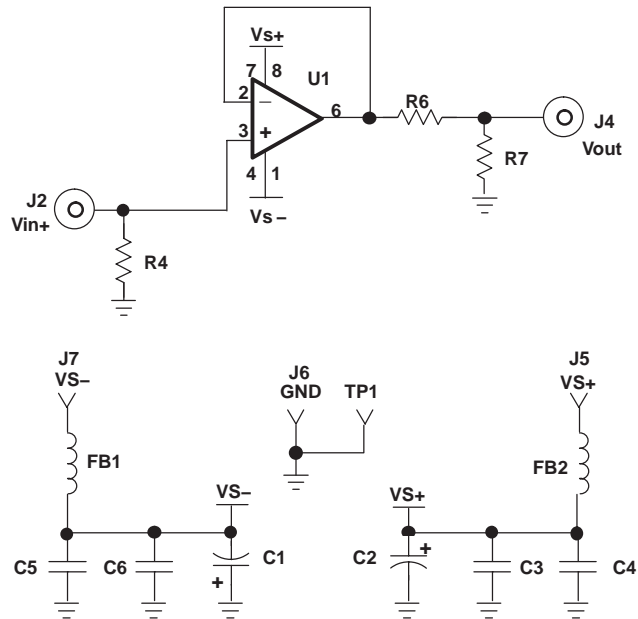

Figure 101. THS4271 Unity Gain EVM Circuit Configuration

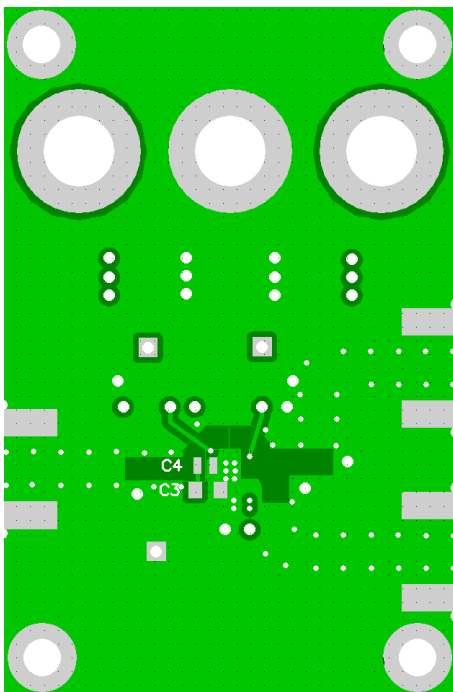

Figure 100. THS4271/THS4275 EVM Board Layout (Bottom Layer)

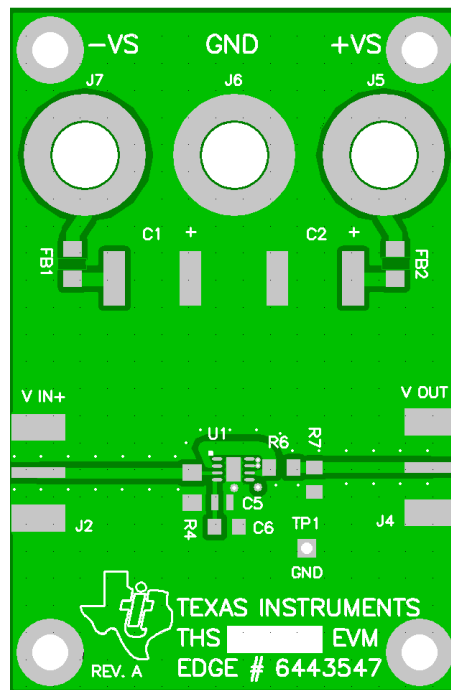

Figure 102. THS4271 Unity Gain EVM Board Layout (Top Layer)

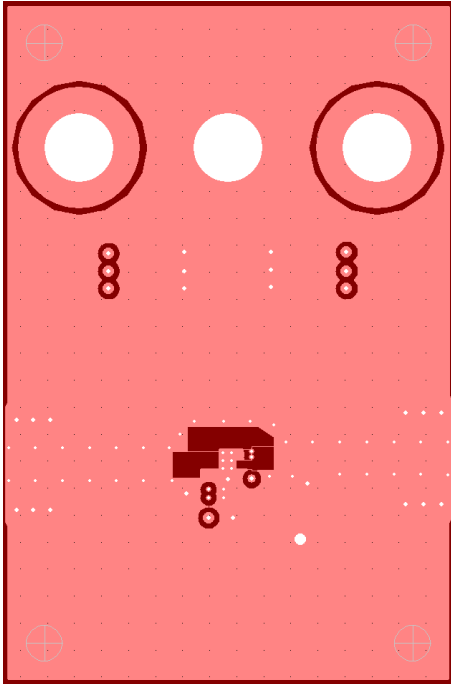

Figure 103. THS4271 Unity Gain EVM Board Layout (Second Layer, Ground)

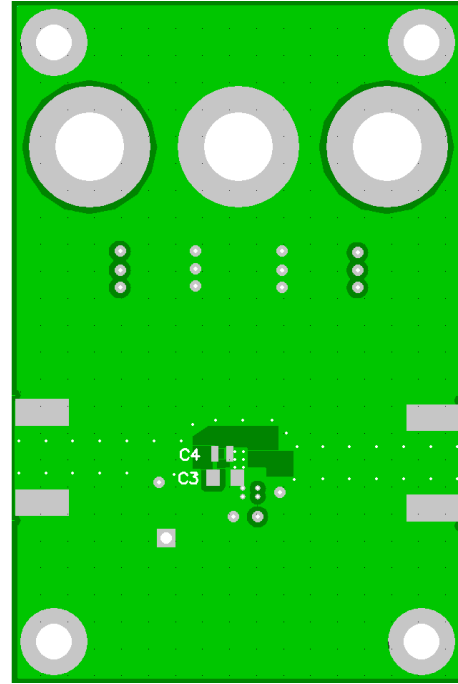

Figure 105. THS4271 Unity Gain EVM Board Layout (Bottom Layer)

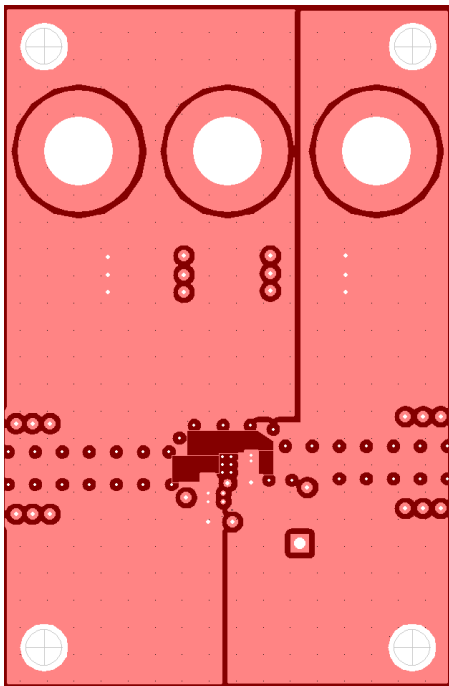

Figure 104. THS4271 Unity Gain EVM Board Layout (Third Layer, Power)

Computer simulation of circuit performance using SPICE is often useful when analyzing the performance of analog circuits and systems. This is particularly true for video and RF amplifier circuits where parasitic capacitance and inductance can have a major effect on circuit performance. A SPICE model for the THS4271 is available through either the Texas Instruments web site (www.ti.com) or as one model on a disk from the Texas Instruments Product Information Center (1-800-548-6132). The PIC is also available for design assistance and detailed product information at this number. These models do a good job of predicting small-signal ac and transient performance under a wide variety of operating conditions. They are not intended to model the distortion characteristics of the amplifier, nor do they attempt to distinguish between the package types in their small-signal ac performance. Detailed information about what is and is not modeled is contained in the model file itself.

ADDITIONAL REFERENCE MATERIAL

- *PowerPAD Made Easy*, application brief (SLMA004)
- *PowerPAD Thermally Enhanced Package*, technical brief (SLMA002)

PACKAGING INFORMATION

| Orderable Device | Status ⁽¹⁾ | Package Type | Package Drawing | Pins | Package Qty | Eco Plan ⁽²⁾ | Lead/Ball Finish | MSL Peak Temp ⁽³⁾ |
|------------------|-----------------------|----------------|-----------------|------|-------------|-------------------------|------------------|------------------------------|
| THS4271MDGNREP | ACTIVE | MSOP-Power PAD | DGN | 8 | 2500 | Green (RoHS & no Sb/Br) | CU NIPDAU | Level-1-260C-UNLIM |
| V62/05610-01YE | ACTIVE | MSOP-Power PAD | DGN | 8 | 2500 | Green (RoHS & no Sb/Br) | CU NIPDAU | Level-1-260C-UNLIM |

⁽¹⁾ The marketing status values are defined as follows:

ACTIVE: Product device recommended for new designs.

LIFEBUY: TI has announced that the device will be discontinued, and a lifetime-buy period is in effect.

NRND: Not recommended for new designs. Device is in production to support existing customers, but TI does not recommend using this part in a new design.

PREVIEW: Device has been announced but is not in production. Samples may or may not be available.

OBSOLETE: TI has discontinued the production of the device.

⁽²⁾ Eco Plan - The planned eco-friendly classification: Pb-Free (RoHS), Pb-Free (RoHS Exempt), or Green (RoHS & no Sb/Br) - please check <http://www.ti.com/productcontent> for the latest availability information and additional product content details.

TBD: The Pb-Free/Green conversion plan has not been defined.

Pb-Free (RoHS): TI's terms "Lead-Free" or "Pb-Free" mean semiconductor products that are compatible with the current RoHS requirements for all 6 substances, including the requirement that lead not exceed 0.1% by weight in homogeneous materials. Where designed to be soldered at high temperatures, TI Pb-Free products are suitable for use in specified lead-free processes.

Pb-Free (RoHS Exempt): This component has a RoHS exemption for either 1) lead-based flip-chip solder bumps used between the die and package, or 2) lead-based die adhesive used between the die and leadframe. The component is otherwise considered Pb-Free (RoHS compatible) as defined above.

Green (RoHS & no Sb/Br): TI defines "Green" to mean Pb-Free (RoHS compatible), and free of Bromine (Br) and Antimony (Sb) based flame retardants (Br or Sb do not exceed 0.1% by weight in homogeneous material)

⁽³⁾ MSL, Peak Temp. -- The Moisture Sensitivity Level rating according to the JEDEC industry standard classifications, and peak solder temperature.

Important Information and Disclaimer:The information provided on this page represents TI's knowledge and belief as of the date that it is provided. TI bases its knowledge and belief on information provided by third parties, and makes no representation or warranty as to the accuracy of such information. Efforts are underway to better integrate information from third parties. TI has taken and continues to take reasonable steps to provide representative and accurate information but may not have conducted destructive testing or chemical analysis on incoming materials and chemicals. TI and TI suppliers consider certain information to be proprietary, and thus CAS numbers and other limited information may not be available for release.

In no event shall TI's liability arising out of such information exceed the total purchase price of the TI part(s) at issue in this document sold by TI to Customer on an annual basis.

OTHER QUALIFIED VERSIONS OF THS4271-EP :

- Catalog: [THS4271](#)

NOTE: Qualified Version Definitions:

- Catalog - TI's standard catalog product

TAPE AND REEL INFORMATION



QUADRANT ASSIGNMENTS FOR PIN 1 ORIENTATION IN TAPE



*All dimensions are nominal

| Device | Package Type | Package Drawing | Pins | SPQ | Reel Diameter (mm) | Reel Width W1 (mm) | A0 (mm) | B0 (mm) | K0 (mm) | P1 (mm) | W (mm) | Pin1 Quadrant |
|----------------|----------------|-----------------|------|------|--------------------|--------------------|---------|---------|---------|---------|--------|---------------|
| THS4271MDGNREP | MSOP-Power PAD | DGN | 8 | 2500 | 330.0 | 12.4 | 5.2 | 3.3 | 1.6 | 8.0 | 12.0 | Q1 |

TAPE AND REEL BOX DIMENSIONS



*All dimensions are nominal

| Device | Package Type | Package Drawing | Pins | SPQ | Length (mm) | Width (mm) | Height (mm) |
|----------------|---------------|-----------------|------|------|-------------|------------|-------------|
| THS4271MDGNREP | MSOP-PowerPAD | DGN | 8 | 2500 | 338.1 | 340.5 | 21.1 |

MECHANICAL DATA

DGN (S-PDSO-G8)

PowerPAD™ PLASTIC SMALL-OUTLINE PACKAGE

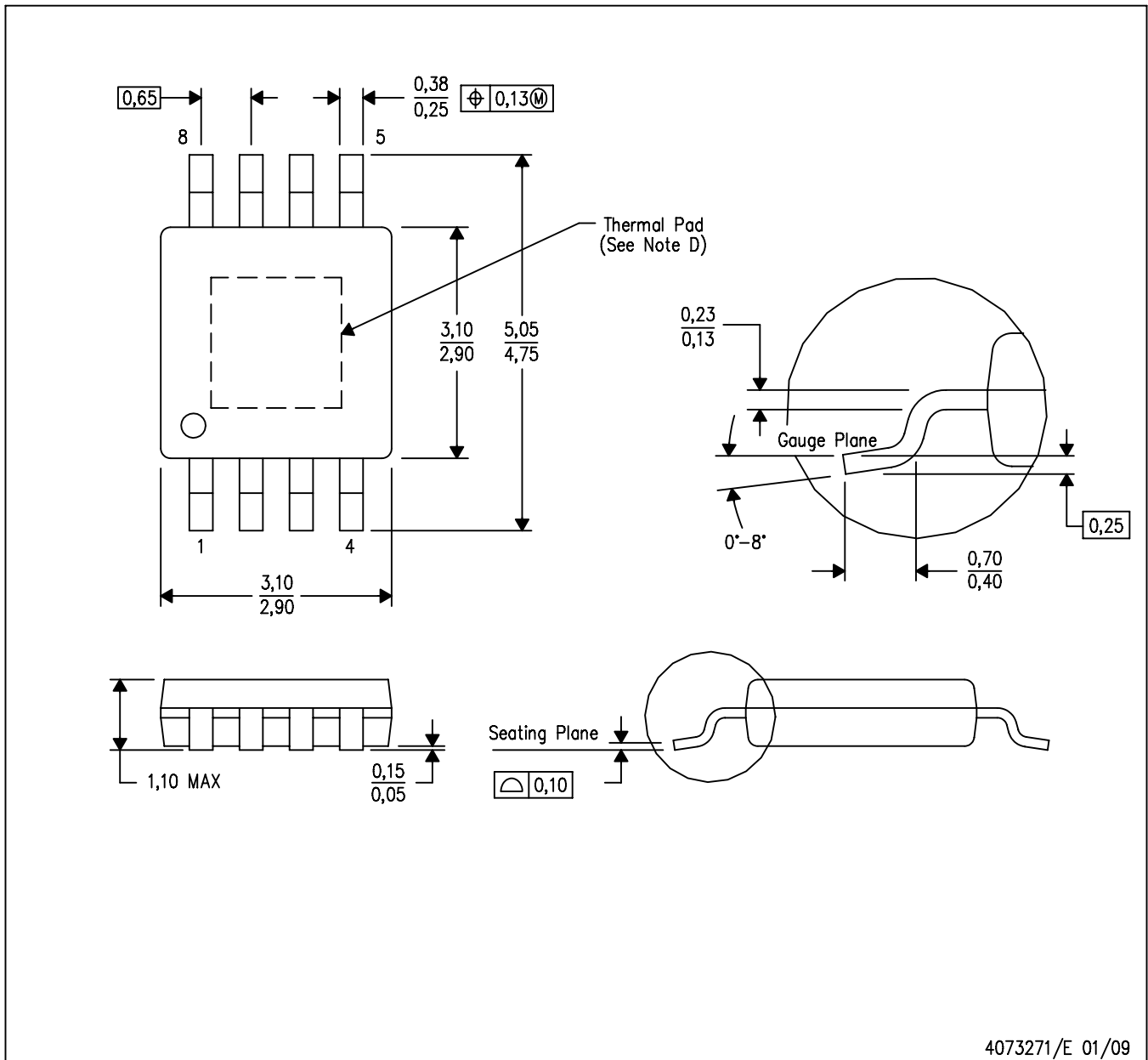

- NOTES:
- A. All linear dimensions are in millimeters.
 - B. This drawing is subject to change without notice.
 - C. Body dimensions do not include mold flash or protrusion.
 - D. This package is designed to be soldered to a thermal pad on the board. Refer to Technical Brief, PowerPAD Thermally Enhanced Package, Texas Instruments Literature No. SLMA002 for information regarding recommended board layout. This document is available at www.ti.com <<http://www.ti.com>>.
 - E. Falls within JEDEC MO-187 variation AA-T

PowerPAD is a trademark of Texas Instruments.

THERMAL INFORMATION

This PowerPAD™ package incorporates an exposed thermal pad that is designed to be attached directly to an external heatsink. The thermal pad must be soldered directly to the printed circuit board (PCB). After soldering, the PCB can be used as a heatsink. In addition, through the use of thermal vias, the thermal pad can be attached directly to the appropriate copper plane shown in the electrical schematic for the device, or alternatively, can be attached to a special heatsink structure designed into the PCB. This design optimizes the heat transfer from the integrated circuit (IC).

For additional information on the PowerPAD package and how to take advantage of its heat dissipating abilities, refer to Technical Brief, PowerPAD Thermally Enhanced Package, Texas Instruments Literature No. SLMA002 and Application Brief, PowerPAD Made Easy, Texas Instruments Literature No. SLMA004. Both documents are available at www.ti.com.

The exposed thermal pad dimensions for this package are shown in the following illustration.

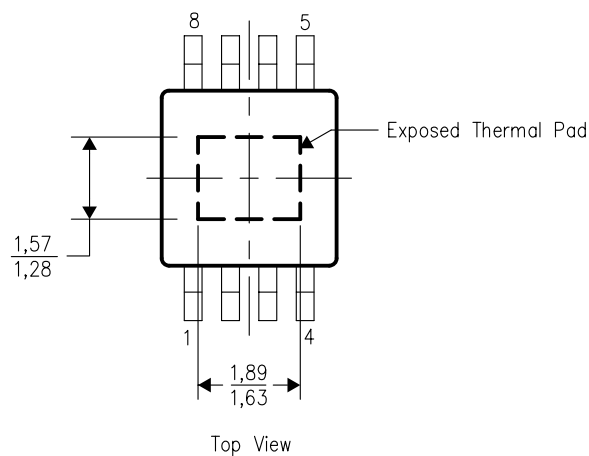

NOTE: All linear dimensions are in millimeters

Exposed Thermal Pad Dimensions

DGN (R-PDS0-G8) PowerPAD™

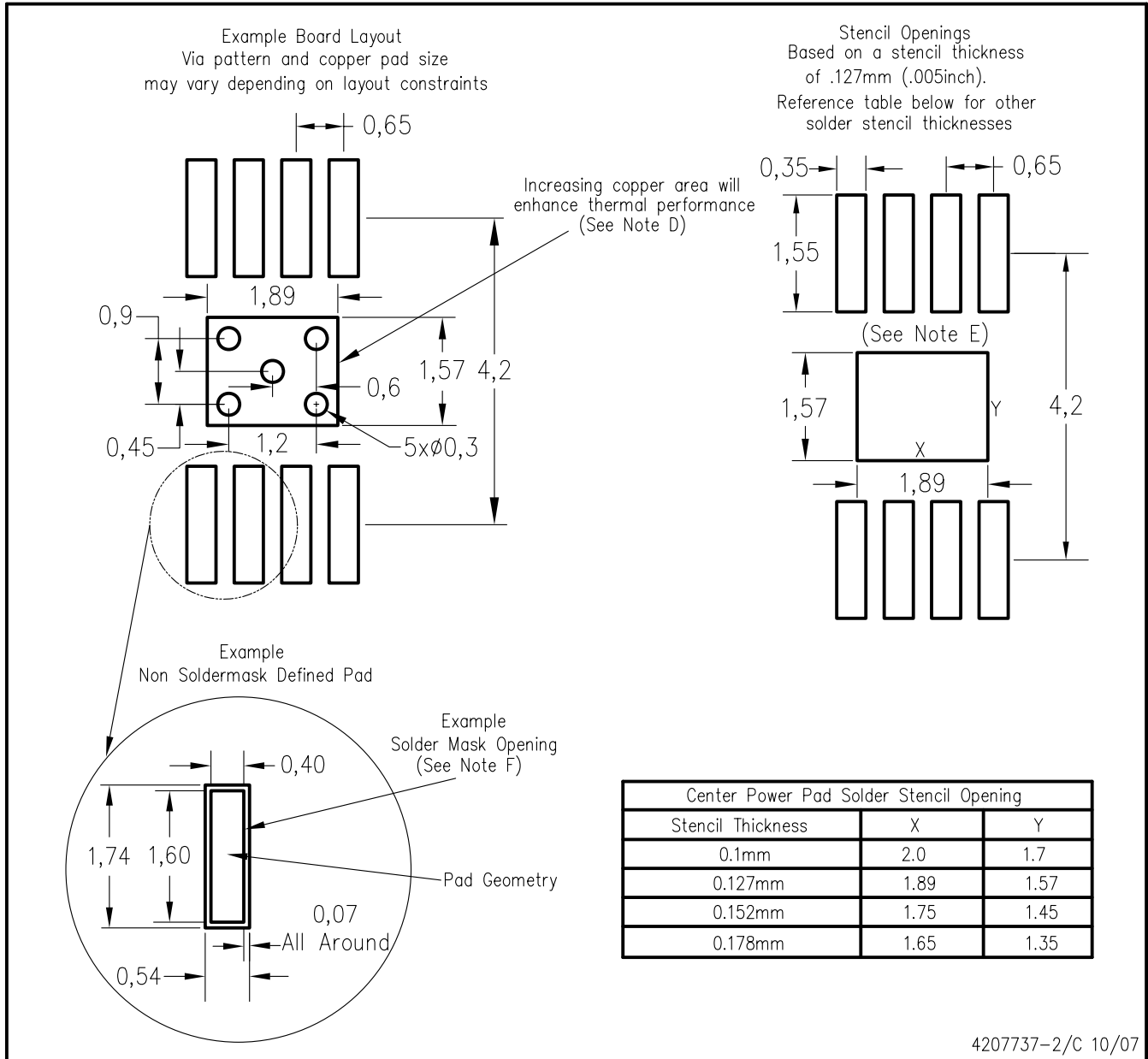

4207737-2/C 10/07

- NOTES:
- A. All linear dimensions are in millimeters.
 - B. This drawing is subject to change without notice.
 - C. Customers should place a note on the circuit board fabrication drawing not to alter the center solder mask defined pad.
 - D. This package is designed to be soldered to a thermal pad on the board. Refer to Technical Brief, PowerPad Thermally Enhanced Package, Texas Instruments Literature No. SLMA002, SLMA004, and also the Product Data Sheets for specific thermal information, via requirements, and recommended board layout. These documents are available at www.ti.com <<http://www.ti.com>>. Publication IPC-7351 is recommended for alternate designs.
 - E. Laser cutting apertures with trapezoidal walls and also rounding corners will offer better paste release. Customers should contact their board assembly site for stencil design recommendations. Example stencil design based on a 50% volumetric metal load solder paste. Refer to IPC-7525 for other stencil recommendations.
 - F. Customers should contact their board fabrication site for solder mask tolerances between and around signal pads.

IMPORTANT NOTICE

Texas Instruments Incorporated and its subsidiaries (TI) reserve the right to make corrections, modifications, enhancements, improvements, and other changes to its products and services at any time and to discontinue any product or service without notice. Customers should obtain the latest relevant information before placing orders and should verify that such information is current and complete. All products are sold subject to TI's terms and conditions of sale supplied at the time of order acknowledgment.

TI warrants performance of its hardware products to the specifications applicable at the time of sale in accordance with TI's standard warranty. Testing and other quality control techniques are used to the extent TI deems necessary to support this warranty. Except where mandated by government requirements, testing of all parameters of each product is not necessarily performed.

TI assumes no liability for applications assistance or customer product design. Customers are responsible for their products and applications using TI components. To minimize the risks associated with customer products and applications, customers should provide adequate design and operating safeguards.

TI does not warrant or represent that any license, either express or implied, is granted under any TI patent right, copyright, mask work right, or other TI intellectual property right relating to any combination, machine, or process in which TI products or services are used. Information published by TI regarding third-party products or services does not constitute a license from TI to use such products or services or a warranty or endorsement thereof. Use of such information may require a license from a third party under the patents or other intellectual property of the third party, or a license from TI under the patents or other intellectual property of TI.

Reproduction of TI information in TI data books or data sheets is permissible only if reproduction is without alteration and is accompanied by all associated warranties, conditions, limitations, and notices. Reproduction of this information with alteration is an unfair and deceptive business practice. TI is not responsible or liable for such altered documentation. Information of third parties may be subject to additional restrictions.

Resale of TI products or services with statements different from or beyond the parameters stated by TI for that product or service voids all express and any implied warranties for the associated TI product or service and is an unfair and deceptive business practice. TI is not responsible or liable for any such statements.

TI products are not authorized for use in safety-critical applications (such as life support) where a failure of the TI product would reasonably be expected to cause severe personal injury or death, unless officers of the parties have executed an agreement specifically governing such use. Buyers represent that they have all necessary expertise in the safety and regulatory ramifications of their applications, and acknowledge and agree that they are solely responsible for all legal, regulatory and safety-related requirements concerning their products and any use of TI products in such safety-critical applications, notwithstanding any applications-related information or support that may be provided by TI. Further, Buyers must fully indemnify TI and its representatives against any damages arising out of the use of TI products in such safety-critical applications.

TI products are neither designed nor intended for use in military/aerospace applications or environments unless the TI products are specifically designated by TI as military-grade or "enhanced plastic." Only products designated by TI as military-grade meet military specifications. Buyers acknowledge and agree that any such use of TI products which TI has not designated as military-grade is solely at the Buyer's risk, and that they are solely responsible for compliance with all legal and regulatory requirements in connection with such use.

TI products are neither designed nor intended for use in automotive applications or environments unless the specific TI products are designated by TI as compliant with ISO/TS 16949 requirements. Buyers acknowledge and agree that, if they use any non-designated products in automotive applications, TI will not be responsible for any failure to meet such requirements.

Following are URLs where you can obtain information on other Texas Instruments products and application solutions:

Products

| | |
|-----------------------------|--|
| Amplifiers | amplifier.ti.com |
| Data Converters | dataconverter.ti.com |
| DLP® Products | www.dlp.com |
| DSP | dsp.ti.com |
| Clocks and Timers | www.ti.com/clocks |
| Interface | interface.ti.com |
| Logic | logic.ti.com |
| Power Mgmt | power.ti.com |
| Microcontrollers | microcontroller.ti.com |
| RFID | www.ti-rfid.com |
| RF/IF and ZigBee® Solutions | www.ti.com/lprf |

Applications

| | |
|--------------------|--|
| Audio | www.ti.com/audio |
| Automotive | www.ti.com/automotive |
| Broadband | www.ti.com/broadband |
| Digital Control | www.ti.com/digitalcontrol |
| Medical | www.ti.com/medical |
| Military | www.ti.com/military |
| Optical Networking | www.ti.com/opticalnetwork |
| Security | www.ti.com/security |
| Telephony | www.ti.com/telephony |
| Video & Imaging | www.ti.com/video |
| Wireless | www.ti.com/wireless |

Mailing Address: Texas Instruments, Post Office Box 655303, Dallas, Texas 75265
Copyright © 2009, Texas Instruments Incorporated