

Features

- Low On-Resistance:
 $R_{DS(ON)} < 120m\Omega$ @ $V_{GS} = -4.5V$
 $R_{DS(ON)} < 240m\Omega$ @ $V_{GS} = -2.5V$
- Low Gate Threshold Voltage
- Low Input Capacitance
- Fast Switching Speed
- Low Input/Output Leakage
- **Lead Free By Design/RoHS Compliant (Note 2)**
- **"Green" Device (Note 3)**
- **Qualified to AEC-Q101 Standards for High Reliability**

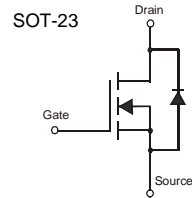

TOP VIEW



Equivalent Circuit

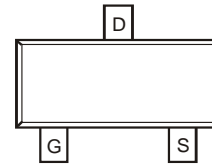

TOP VIEW

Mechanical Data

- Case: SOT-23
- Case Material: Molded Plastic, "Green" Molding Compound. UL Flammability Classification Rating 94V-0
- Moisture Sensitivity: Level 1 per J-STD-020D
- Terminals: Finish – Matte Tin annealed over Copper leadframe. Solderable per MIL-STD-202, Method 208
- Terminal Connections: See Diagram
- Marking Information: See Page 4
- Ordering Information: See Page 4
- Weight: 0.008 grams (approximate)

Maximum Ratings @ $T_A = 25^\circ C$ unless otherwise specified

Characteristic	Symbol	Value	Unit
Drain Source Voltage	V_{DSS}	-30	V
Gate-Source Voltage	V_{GSS}	± 12	V
Drain Current (Note 1)	I_D	$T_A = 25^\circ C$	-2.8
		$T_A = 70^\circ C$	-2.2
Drain Current (Note 1)	I_{DM}	-9	A
Body-Diode Continuous Current (Note 1)	I_S	-2.0	A

Thermal Characteristics

Characteristic	Symbol	Value	Unit
Total Power Dissipation (Note 1)	P_D	1.4	W
Thermal Resistance, Junction to Ambient @ $T_A = 25^\circ C$ (Note 1)	$R_{\theta JA}$	90	$^\circ C/W$
Operating and Storage Temperature Range	T_J, T_{STG}	-55 to +150	$^\circ C$

- Notes:
1. Device mounted on FR-4 PCB. $t \leq 5$ sec.
 2. No purposefully added lead.
 3. Diodes Inc.'s "Green" policy can be found on our website at http://www.diodes.com/products/lead_free/index.php.

Electrical Characteristics @ $T_A = 25^\circ\text{C}$ unless otherwise specified

Characteristic	Symbol	Min	Typ	Max	Unit	Test Condition
OFF CHARACTERISTICS (Note 4)						
Drain-Source Breakdown Voltage	BV_{DSS}	-30	—	—	V	$V_{GS} = 0V, I_D = -250\mu A$
Zero Gate Voltage Drain Current	I_{DSS}	—	—	-1	μA	$V_{DS} = -30V, V_{GS} = 0V$
Gate-Body Leakage	I_{GSS}	—	—	± 100	nA	$V_{GS} = \pm 12V, V_{DS} = 0V$
ON CHARACTERISTICS (Note 4)						
Gate Threshold Voltage	$V_{GS(th)}$	-0.6	—	-1.4	V	$V_{DS} = V_{GS}, I_D = -250\mu A$
Static Drain-Source On-Resistance	$R_{DS(on)}$	—	—	120 240	m Ω	$V_{GS} = -4.5V, I_D = -2.8A$ $V_{GS} = -2.5V, I_D = -1.8A$
Forward Transconductance	g_{fs}	—	5	—	S	$V_{DS} = -5V, I_D = -2.8A$
Source-Drain Diode Forward Voltage	V_{SD}	—	—	-1.1	V	$V_{GS} = 0V, I_S = -2.0A$
DYNAMIC CHARACTERISTICS						
Input Capacitance	C_{iss}	—	285	—	pF	$V_{DS} = -15V, V_{GS} = 0V$ $f = 1.0MHz$
Output Capacitance	C_{oss}	—	56	—	pF	
Reverse Transfer Capacitance	C_{rss}	—	40	—	pF	
Gate Resistance	R_G	—	13	—	Ω	$V_{DS} = 0V, V_{GS} = 0V$ $f = 1.0MHz$
SWITCHING CHARACTERISTICS						
Turn-On Delay Time	$t_{d(on)}$	—	5.6	—	ns	$V_{DS} = -15V, V_{GS} = -4.5V,$ $I_D = -1A, R_G = 6.0\Omega$
Rise Time	t_r	—	6.8	—		
Turn-Off Delay Time	$t_{d(off)}$	—	35.3	—		
Fall Time	t_f	—	19.2	—		
Total Gate Charge	Q_G	—	6.7 3.0	—	nC	$V_{DS} = -15V, V_{GS} = -10V, I_D = -1.0A$
Gate-Source Charge	Q_{GS}	—	0.8	—		$V_{DS} = -15V, V_{GS} = -4.5V, I_D = -1.0A$
Gate-Drain Charge	Q_{GD}	—	0.5	—		

Notes: 4. Short duration pulse test used to minimize self-heating effect.

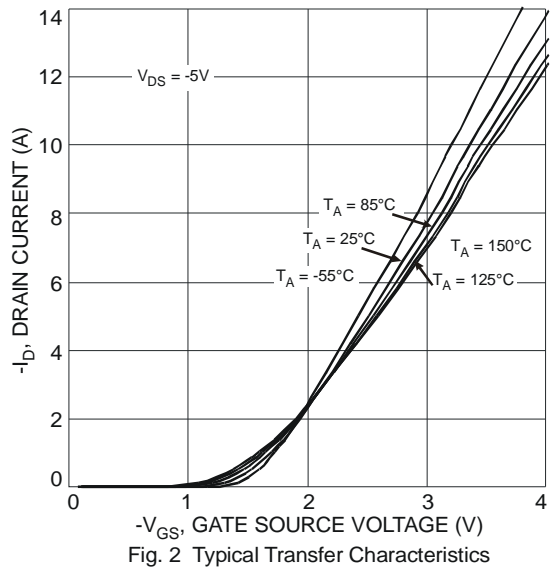
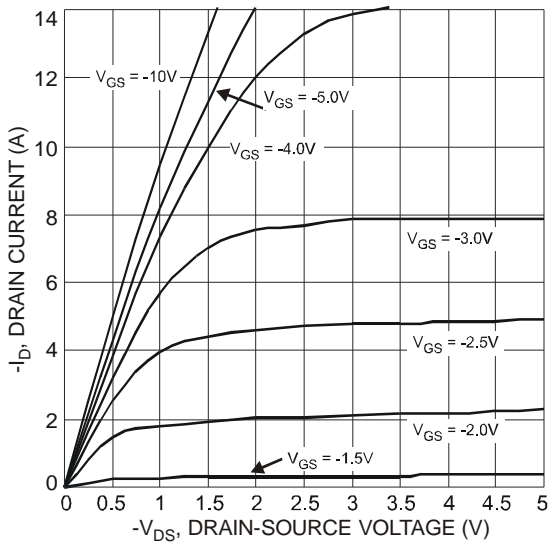

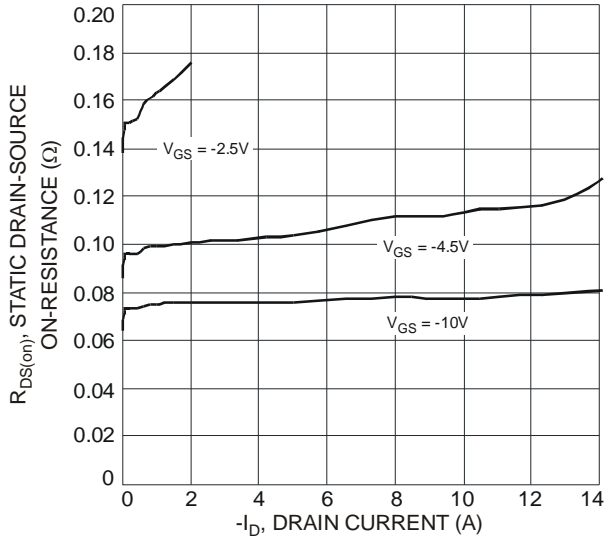

Fig. 3 On-Resistance vs. Drain Current and Gate Voltage

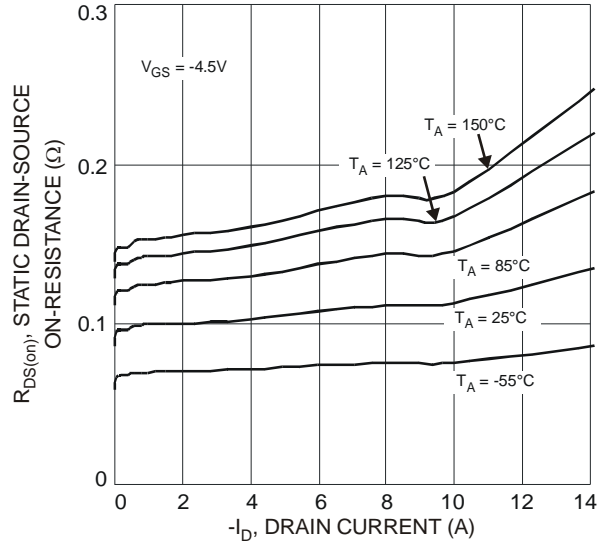

Fig. 4 On-Resistance vs. Drain Current and Temperature

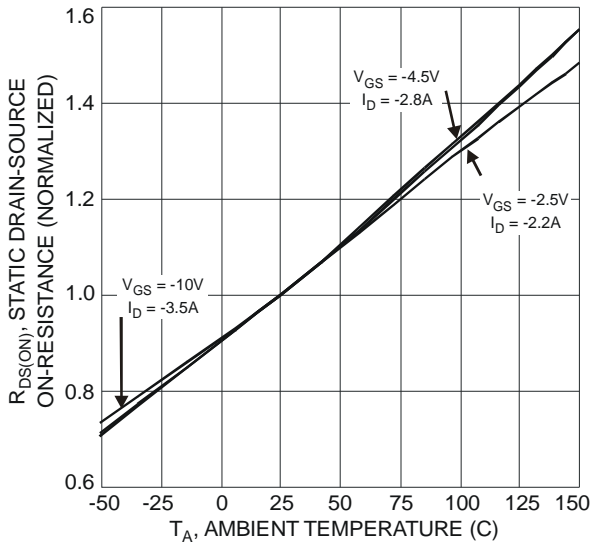

Fig. 5 Normalized Static Drain-Source On-Resistance vs. Ambient Temperature

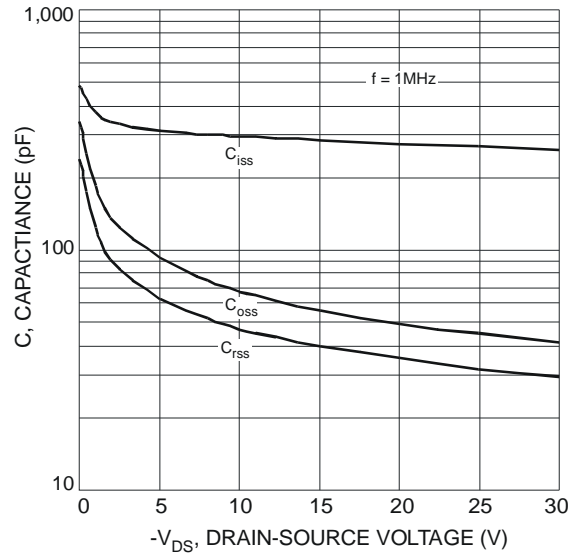

Fig. 6 Typical Capacitance

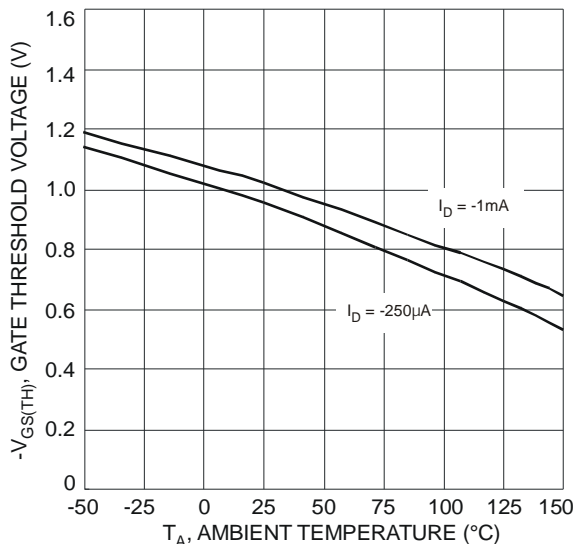

Fig. 7 Gate Threshold Voltage vs. Ambient Temperature

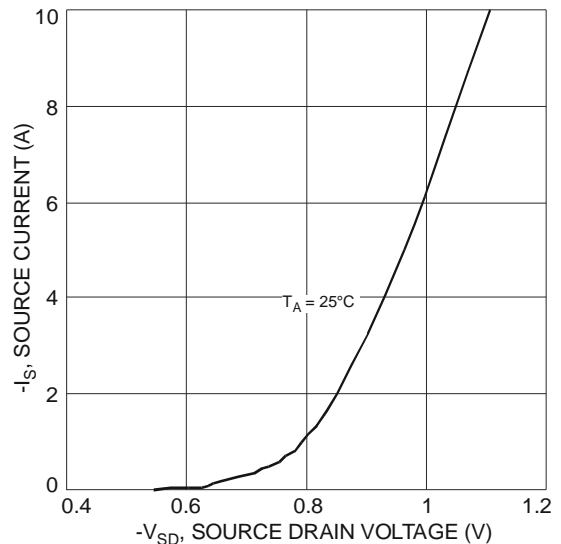

Fig. 8 Reverse Drain Current vs. Source-Drain Voltage

Ordering Information (Note 5)

Part Number	Case	Packaging
DMP3120L-7	SOT-23	3000/Tape & Reel

Notes: 5. For packaging details, go to our website at <http://www.diodes.com/datasheets/ap02007.pdf>.

Marking Information

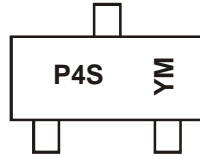

P4S = Product Type Marking Code
 YM = Date Code Marking
 Y = Year (ex: V = 2008)
 M = Month (ex: 9 = September)

Date Code Key

Year	2008	2009	2010	2011	2012	2013	2014	2015				
Code	V	W	X	Y	Z	A	B	C				
Month	Jan	Feb	Mar	Apr	May	Jun	Jul	Aug	Sep	Oct	Nov	Dec
Code	1	2	3	4	5	6	7	8	9	O	N	D

Package Outline Dimensions

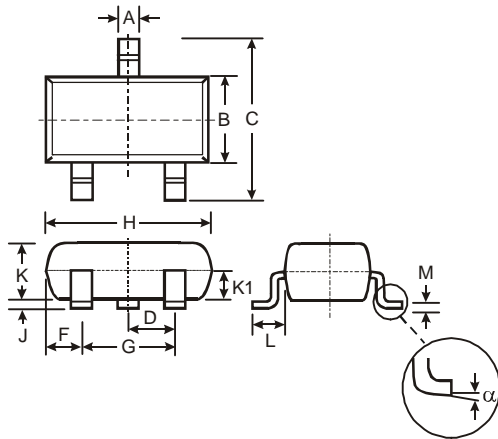

SOT-23			
Dim	Min	Max	Typ
A	0.37	0.51	0.40
B	1.20	1.40	1.30
C	2.30	2.50	2.40
D	0.89	1.03	0.915
F	0.45	0.60	0.535
G	1.78	2.05	1.83
H	2.80	3.00	2.90
J	0.013	0.10	0.05
K	0.903	1.10	1.00
K1	-	-	0.400
L	0.45	0.61	0.55
M	0.085	0.18	0.11
α	0°	8°	-

All Dimensions in mm

Suggested Pad Layout

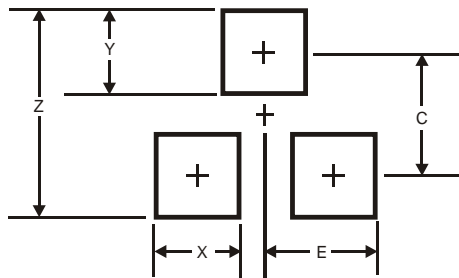

Dimensions	Value (in mm)
Z	2.9
X	0.8
Y	0.9
C	2.0
E	1.35

IMPORTANT NOTICE

Diodes Incorporated and its subsidiaries reserve the right to make modifications, enhancements, improvements, corrections or other changes without further notice to any product herein. Diodes Incorporated does not assume any liability arising out of the application or use of any product described herein; neither does it convey any license under its patent rights, nor the rights of others. The user of products in such applications shall assume all risks of such use and will agree to hold Diodes Incorporated and all the companies whose products are represented on our website, harmless against all damages.

LIFE SUPPORT

Diodes Incorporated products are not authorized for use as critical components in life support devices or systems without the expressed written approval of the President of Diodes Incorporated.