

ASMT-Jx1x

1W Power LED Light Source



Data Sheet



Lead (Pb) Free
RoHS 6 fully
compliant



Description

This 1W Power LED Light Source is a high performance energy efficient device which can handle high thermal and high driving current. Option with electrically isolated metal slug is also available.

The White Power LED is available in the range of color temperature from 2700K to 10000K.

The low profile package design and ultra small footprint is suitable for a wide variety of applications especially where space and height is a constraint.

The package is compatible with reflow soldering process. To facilitate easy pick & place assembly, the LEDs are packed in EIA-compliant tape and reel.

Features

- Available in Red, Amber, Green, Blue, Cool White, Neutral White and Warm White
- Small footprint
- Energy efficient
- Direct heat transfer from metal slug to mother board
- Compatible with reflow soldering process
- High current operation
- Long operation life
- Wide viewing angle
- Silicone encapsulation
- Non-ESD sensitive (threshold > 16kV)
- MSL 1 products

Applications

- Architectural lighting
- Garden lighting
- Decorative lighting
- Sign backlight
- Safety, exit and emergency sign lightings
- Specialty lighting such as task lighting and reading lights
- Retail display
- Commercial lighting
- Accent or marker lightings, strip or step lightings
- Portable lightings, bicycle head lamp, torch lights.
- Pathway lighting
- Street lighting
- Tunnel lighting

CAUTION: Customer is advised to keep the LEDs in the MBB when not in use as prolonged exposure to environment might cause the silver plated leads to tarnish, which might cause difficulties in soldering.

Package Dimensions

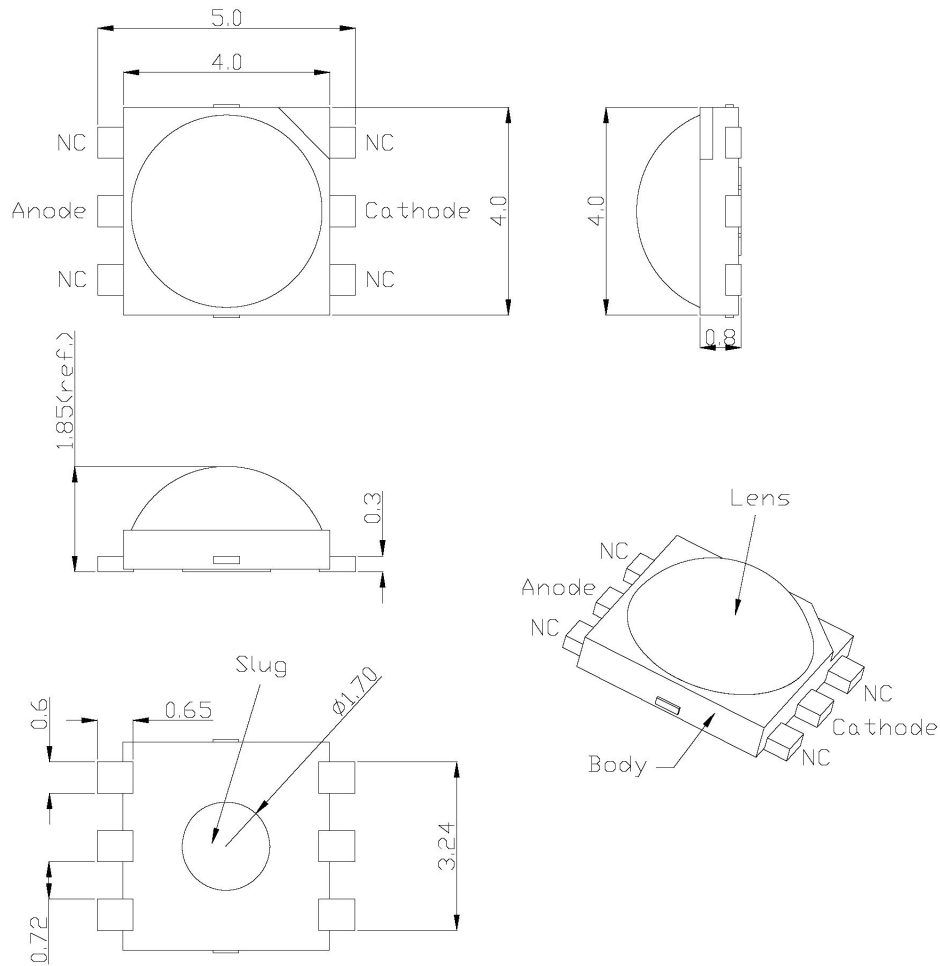

Notes:

1. All dimensions in millimeters.
2. Metal slug is connected to anode for electrically non-isolated option.
3. Tolerance is ± 0.1 mm unless otherwise specified.

Device Selection Guide ($T_J = 25^\circ\text{C}$)

Part Number	Color	Luminous Flux, $\Phi_V^{[1,2]}$ (lm)			Test Current (mA)	Dice Technology	Electrically Isolated Metal Slug
		Min.	Typ.	Max.			
ASMT-JR10-ARS01	Red	39.8	45	67.2	350	AllInGaP	No
ASMT-JA10-ARS01	Amber	39.8	45	67.2	350	AllInGaP	No
ASMT-JB11-NLN01	Blue	10.7	15	23.5	350	InGaN	Yes
ASMT-JG11-NST01	Green	51.7	70	87.4	350	InGaN	Yes
ASMT-JW11-NTT01	Cool White	67.2	70	87.4	350	InGaN	Yes
ASMT-JN11-NST01	Neutral White	51.7	65	87.4	350	InGaN	Yes
ASMT-JY11-NST01	Warm White	51.7	60	87.4	350	InGaN	Yes

Notes:

1. Φ_V is the total luminous flux output as measured with an integrating sphere at 25ms mono pulse condition.
2. Flux tolerance is $\pm 10\%$

Part Numbering System

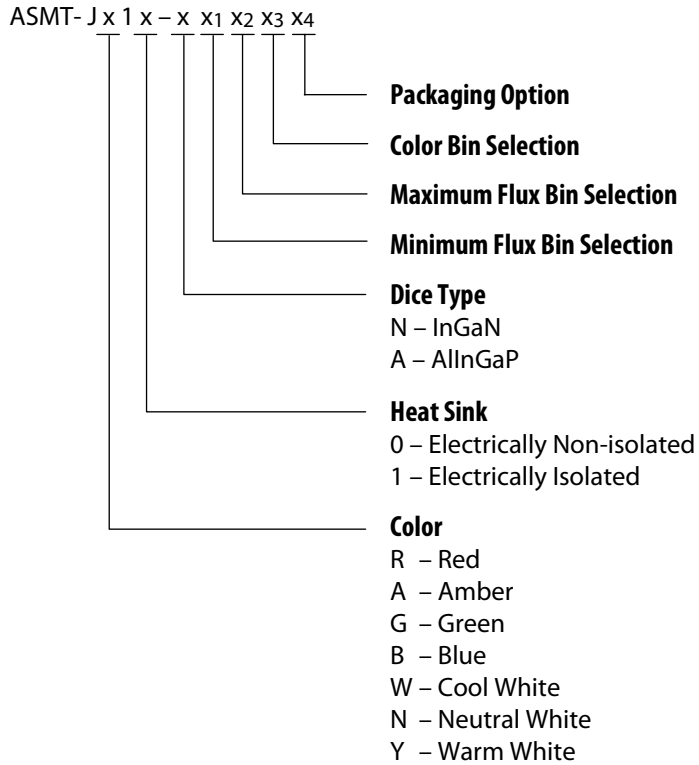

Note:

1. Please refer to Page 10 for selection details.

Absolute Maximum Ratings

Parameter	AllInGaP	InGaN	Units
DC Forward Current ^[1]	350	350	mA
Power Dissipation	1085	1400	mW
Reverse Voltage	5	5	V
LED Junction Temperature	125	150	°C
Operating Metal Slug Temperature Range at 350 mA	-40 to +115	-40 to +135	°C
Storage Temperature Range	-40 to +120	-40 to +135	°C
Soldering Temperature		Refer to Figure 16	

Note:

1. Derate linearly based on Figure 7 for AllInGaP and Figure 17 for InGaN.

Optical Characteristics at 350 mA (T_J = 25°C)

Part Number	Color	Peak Wavelength, λ_{PEAK} (nm)	Dominant Wavelength, λ_{D} [1] (nm)	Viewing Angle, $2\theta_{1/2}$ [2] (°)	Luminous Efficiency (lm/W)
		Typ.	Typ.	Typ.	Typ.
ASMT-JR10	Red	635	625	165	54
ASMT-JA10	Amber	598	590	165	54
ASMT-JG11	Green	519	525	165	57
ASMT-JB11	Blue	460	470	165	12

Part Number	Color	Correlated Color Temperature, CCT (Kelvin)		Viewing Angle, $2\theta_{1/2}$ [2] (°)	Luminous Efficiency (lm/W)
		Min.	Max.	Typ.	Typ.
ASMT-JW11	Cool White	4500	10000	140	57
ASMT-JN11	Neutral White	3500	4500	140	53
ASMT-JY11	Warm White	2700	3500	140	49

Notes:

1. The dominant wavelength, λ_{D} , is derived from the CIE Chromaticity Diagram and represents the color of the device.
2. $\theta_{1/2}$ is the off-axis angle where the luminous intensity is 1/2 the peak intensity.

Electrical Characteristic at 350 mA (T_J = 25°C)

Dice Type	Forward Voltage, V_{F} (Volts) at $I_{\text{F}} = 350\text{mA}$			Thermal Resistance, $R_{\theta_{\text{j-ms}}}$ (°C/W) [1]
	Min.	Typ.	Max.	Typ.
AllnGaP	1.9	2.4	3.1	10
InGaN	2.8	3.5	4.0	10

Note:

1. $R_{\theta_{\text{j-ms}}}$ is Thermal Resistance from LED junction to metal slug.

AlInGaP

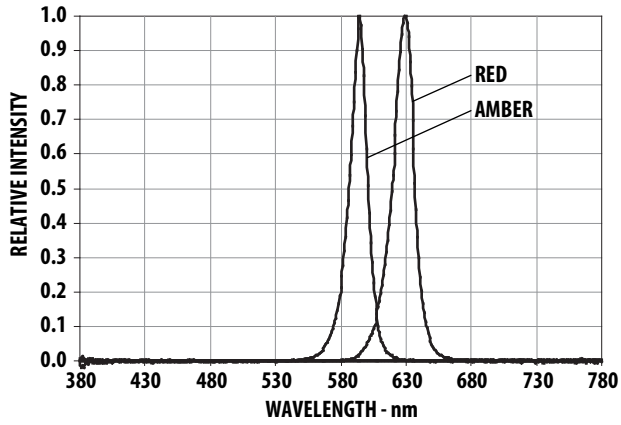

Figure 1. Relative Intensity vs. Wavelength.

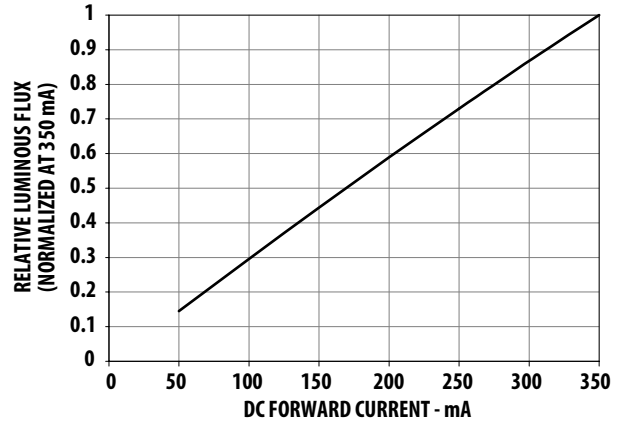

Figure 2. Relative Luminous Flux vs. Mono Pulse Current.

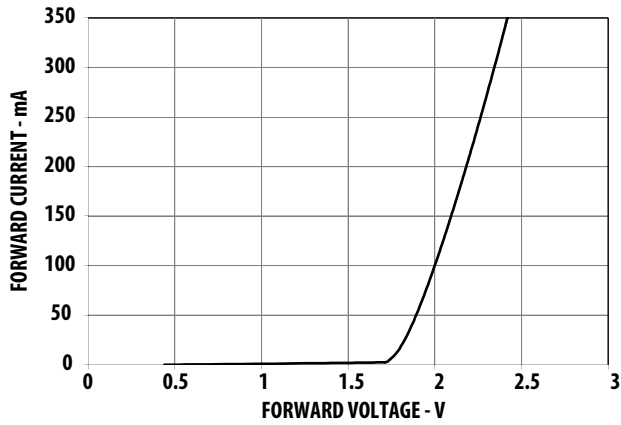

Figure 3. Forward Current vs. Forward Voltage.

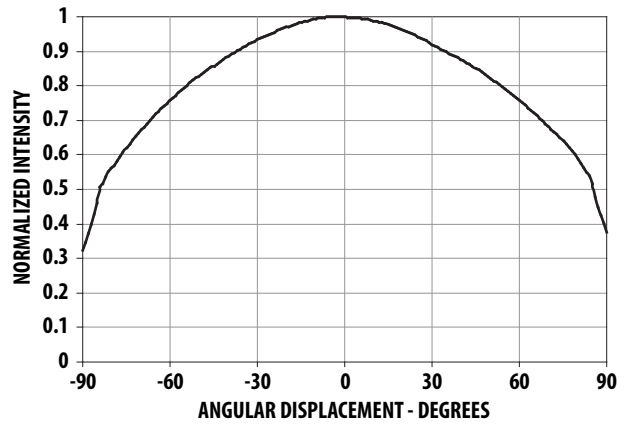

Figure 4. Radiation Pattern Red and Amber.

AllnGaP

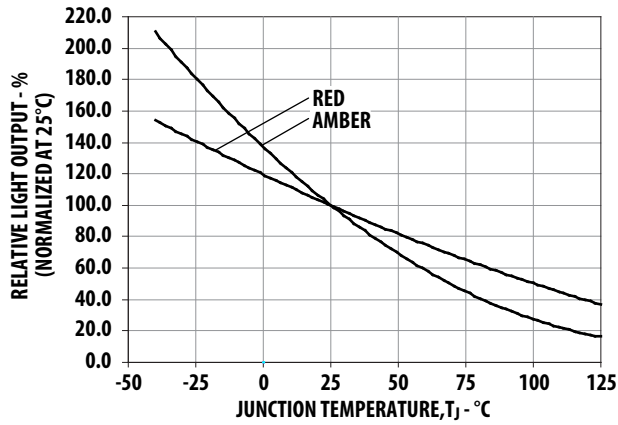

Figure 5. Relative Light Output vs. Junction Temperature.

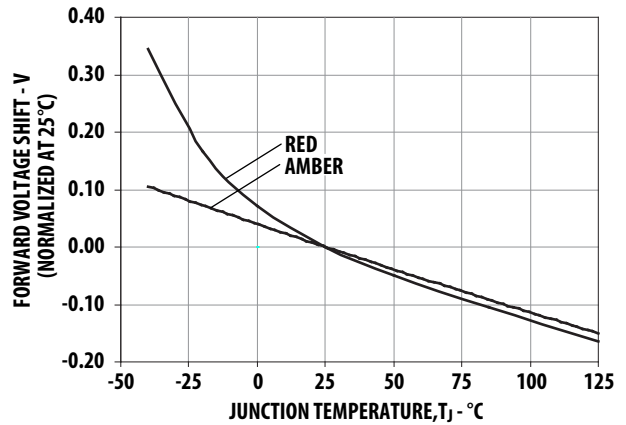

Figure 6. Forward Voltage Shift vs. Junction Temperature.

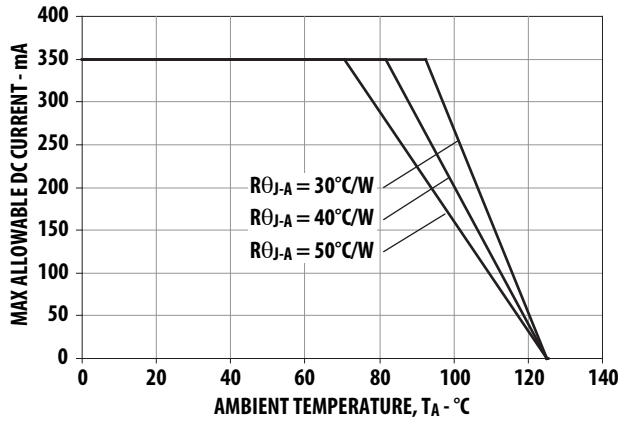

Figure 7. Maximum Forward Current vs. Ambient Temperature. Derated based on $T_{JMAX} = 125^{\circ}C$, $R_{\theta j-a} = 30^{\circ}C/W$, $40^{\circ}C/W$ and $50^{\circ}C/W$.

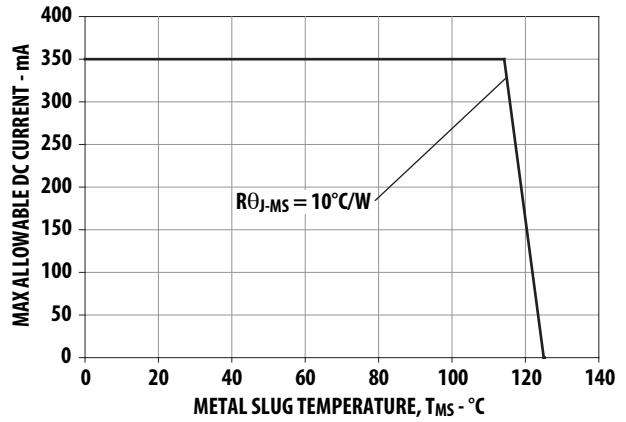

Figure 8. Maximum Forward Current vs. Metal Slug Temperature. Derated based on $T_{JMAX} = 125^{\circ}C$, $R_{\theta j-ms} = 10^{\circ}C/W$.

InGaN

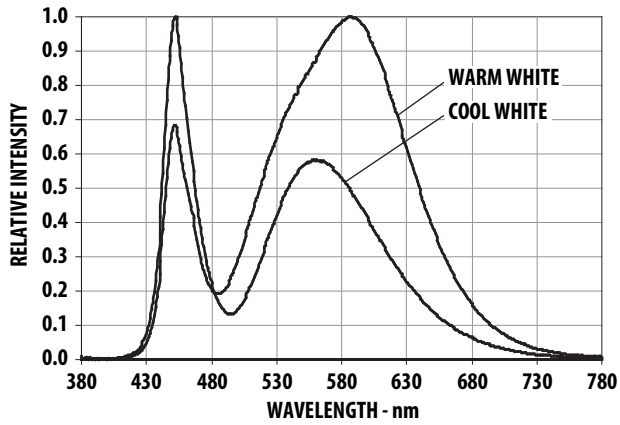

Figure 9. Relative Intensity vs. Wavelength for Cool and Warm White.

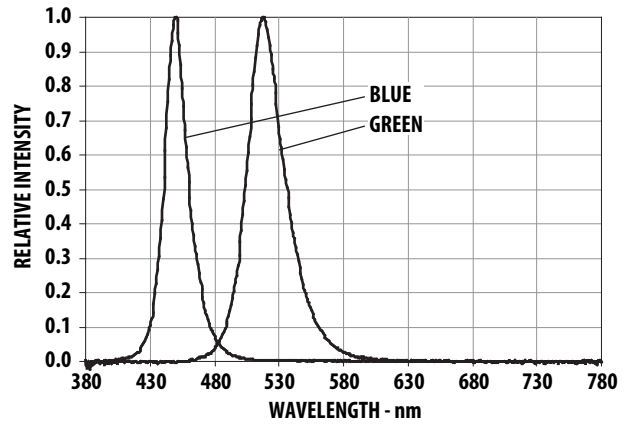

Figure 10. Relative Intensity vs. Wavelength for Blue and Green.

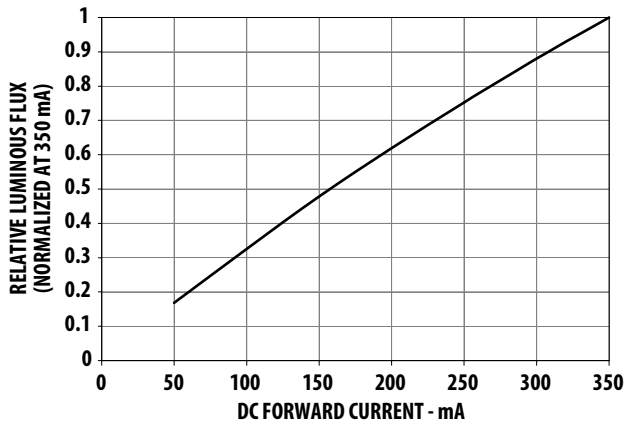

Figure 11. Relative Luminous Flux vs. Mono Pulse Current.

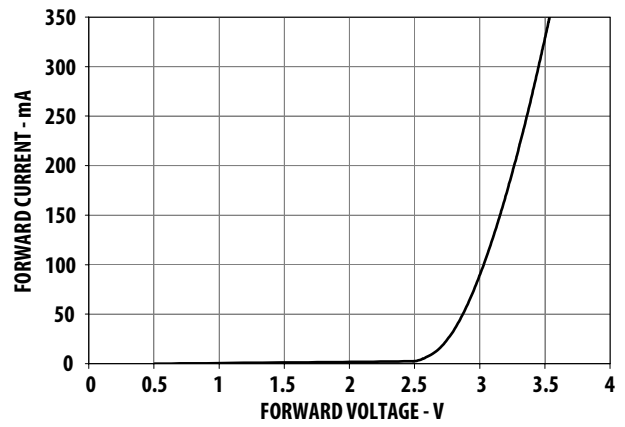

Figure 12. Forward Current vs. Forward Voltage.

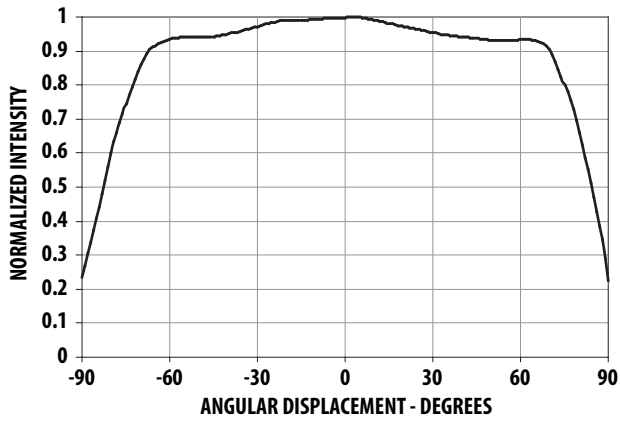

Figure 13. Radiation Pattern for Blue and Green.



Figure 14. Radiation Pattern for Cool White and Warm White.

InGaN

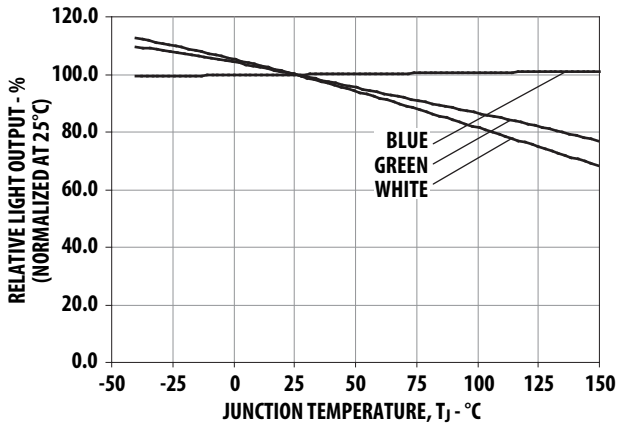

Figure 15. Relative Light Output vs. Junction Temperature.

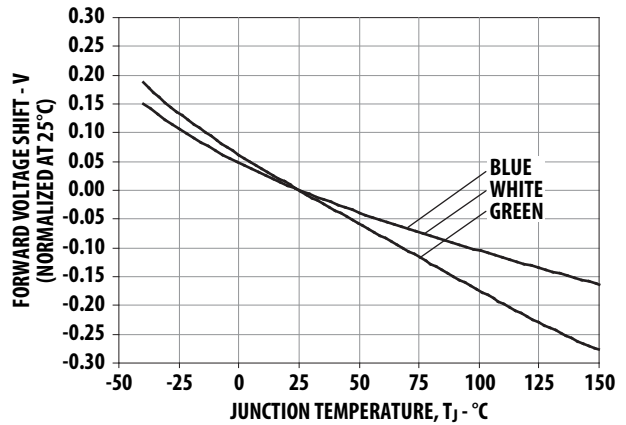

Figure 16. Forward Voltage Shift vs. Junction Temperature.

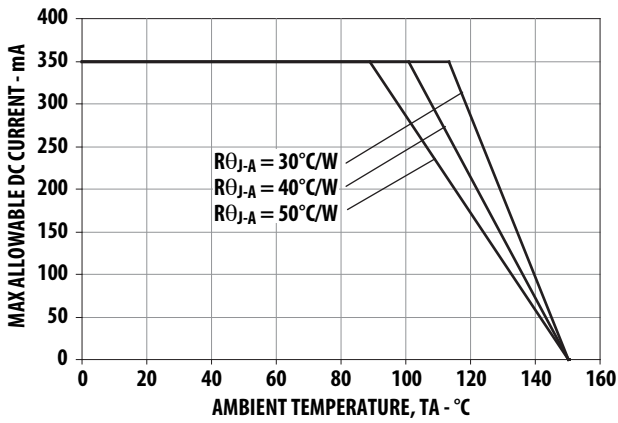

Figure 17. Maximum Forward Current vs. Ambient Temperature. Derated based on $T_{JMAX} = 150^{\circ}C$, $R_{\theta J-A} = 30^{\circ}C/W$, $40^{\circ}C/W$ and $50^{\circ}C/W$.

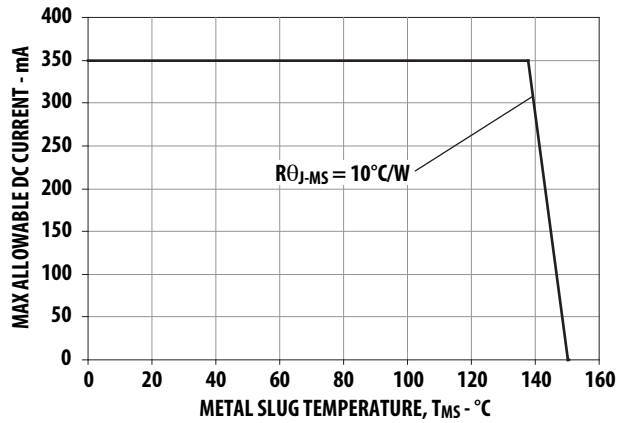

Figure 18. Maximum Forward Current vs. Metal Slug Temperature. Derated based on $T_{JMAX} = 150^{\circ}C$, $R_{\theta J-MS} = 10^{\circ}C/W$.

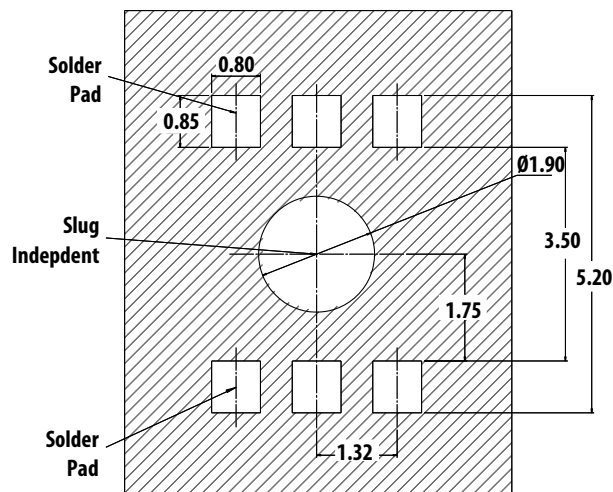

Figure 19. Recommended soldering land pattern.

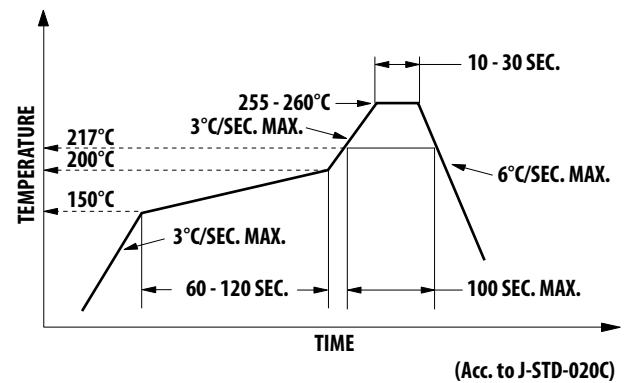

Figure 20. Recommended Reflow Soldering Profile.

Note: For detail information on reflow soldering of Avago surface mount LEDs, do refer to Avago Application Note AN 1060 Surface Mounting SMT LED Indicator Components.

Option Selection Details

ASMT-Jx1x – x x₁ x₂ x₃ x₄

x₁ – Minimum Flux Bin Selection

x₂ – Maximum Flux Bin Selection

x₃ – Color Bin Selection

x₄ – Packaging Option

Flux Bin Limit [x₁, x₂]

Color	Bin ID	Luminous Flux (lm) at 350 mA	
		Min.	Max.
Blue	K	8.2	10.7
	L	10.7	13.9
	M	13.9	18.1
	N	18.1	23.5
Other Colors	Q	30.6	39.8
	R	39.8	51.7
	S	51.7	67.2
	T	67.2	87.4

Tolerance for each bin limits is ±10%

Color Bin Selection (x₃)

Individual reel will contain parts from one full bin only.

Cool White

O	Full Distribution
E	VM, UM, VN and UN
F	WM, VM, WN and VN
G	XM, WM, XN and WN
H	UN, VN, U0 and V0
J	WN, VN, W0 and V0
K	XN, WN, X0 and W0
L	V0, U0, VP and UP
M	W0, V0, WP, VP and WQ
N	X0, W0, XP, WP and WQ
P	Y0
Q	YA

Neutral White

O	Full Distribution
E	SM, RM, S1 and R1
F	TM, SM, TN and S1
G	S1, R1, S0 and R0
H	TN, S1, T0 and S0
J	S0, R0, SA and RA
K	T0, S0, TP and SA

Warm White

O	Full Distribution
E	NM, MM, N1 and M1
F	PM, NM, P1 and N1
G	QM, PM, Q1 and P1
H	M1, N1, M0 and N0
J	P1, N1, P0 and N0
K	Q1, P1, Q0 and P0
L	N0, M0, NA and MA
M	P0, N0, PA and NA
N	Q0, P0, QA and PA

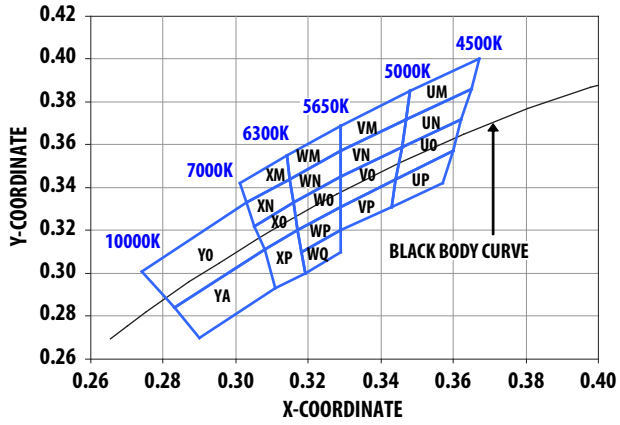

Figure 21. Color bin Structure for Cool White.

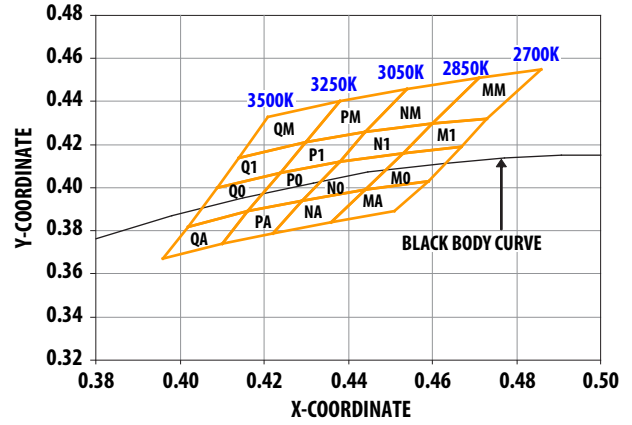

Figure 22. Color bin structure for Warm White.

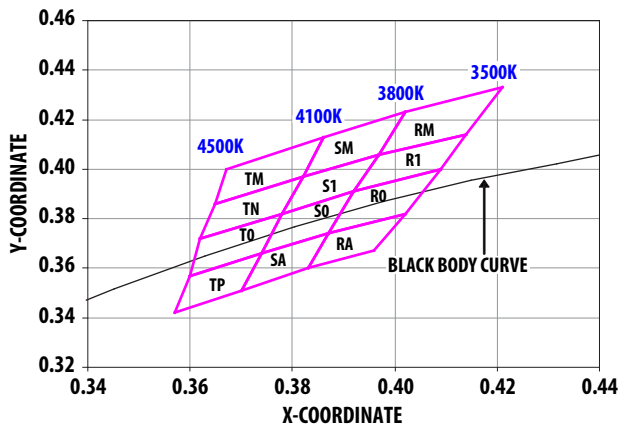

Figure 23. Color bin structure for Neutral White.

Color Bin Limits

Cool White	Color Limits (Chromaticity Coordinates)				
		x	y	z	w
Bin UM	x	0.365	0.348	0.347	0.367
	y	0.386	0.385	0.372	0.400
Bin UN	x	0.365	0.362	0.346	0.347
	y	0.386	0.372	0.359	0.372
Bin UO	x	0.362	0.360	0.344	0.346
	y	0.372	0.357	0.344	0.359
Bin UP	x	0.360	0.357	0.343	0.344
	y	0.357	0.342	0.331	0.344
Bin VM	x	0.329	0.329	0.348	0.347
	y	0.357	0.369	0.385	0.372
Bin VN	x	0.329	0.329	0.347	0.346
	y	0.345	0.357	0.372	0.359
Bin VO	x	0.329	0.329	0.346	0.344
	y	0.331	0.345	0.359	0.344
Bin VP	x	0.329	0.344	0.343	0.329
	y	0.331	0.344	0.331	0.320
Bin WM	x	0.329	0.329	0.315	0.314
	y	0.369	0.357	0.344	0.355
Bin WN	x	0.329	0.316	0.315	0.329
	y	0.345	0.333	0.344	0.357
Bin W0	x	0.329	0.329	0.317	0.316
	y	0.345	0.331	0.320	0.333
Bin WP	x	0.329	0.329	0.318	0.317
	y	0.331	0.320	0.310	0.320
Bin WQ	x	0.329	0.329	0.319	0.318
	y	0.320	0.310	0.300	0.310
Bin XM	x	0.301	0.314	0.315	0.303
	y	0.342	0.355	0.344	0.333
Bin XN	x	0.305	0.303	0.315	0.316
	y	0.322	0.333	0.344	0.333
Bin XO	x	0.308	0.305	0.316	0.317
	y	0.311	0.322	0.333	0.320
Bin XP	x	0.308	0.317	0.319	0.311
	y	0.311	0.320	0.300	0.293
Bin YO	x	0.308	0.283	0.274	0.303
	y	0.311	0.284	0.301	0.333
Bin YA	x	0.308	0.311	0.290	0.283
	y	0.311	0.293	0.270	0.284

Tolerance: ±0.01

Warm White	Color Limits (Chromaticity Coordinates)				
		x	y	z	w
Bin MM	x	0.471	0.460	0.473	0.486
	y	0.451	0.430	0.432	0.455
Bin M1	x	0.460	0.453	0.467	0.473
	y	0.430	0.416	0.419	0.432
Bin M0	x	0.453	0.444	0.459	0.467
	y	0.416	0.399	0.403	0.419
Bin MA	x	0.459	0.444	0.436	0.451
	y	0.403	0.399	0.384	0.389
Bin NM	x	0.454	0.444	0.460	0.453
	y	0.446	0.426	0.430	0.416
Bin N1	x	0.444	0.438	0.453	0.436
	y	0.426	0.412	0.416	0.384
Bin N0	x	0.438	0.429	0.444	0.460
	y	0.412	0.394	0.399	0.430
Bin NA	x	0.444	0.429	0.422	0.471
	y	0.399	0.394	0.379	0.451
Bin PM	x	0.438	0.430	0.444	0.454
	y	0.440	0.421	0.426	0.446
Bin P1	x	0.430	0.424	0.438	0.444
	y	0.421	0.407	0.412	0.426
Bin P0	x	0.424	0.416	0.429	0.438
	y	0.407	0.389	0.394	0.412
Bin PA	x	0.429	0.416	0.410	0.422
	y	0.394	0.389	0.374	0.379
Bin QM	x	0.421	0.414	0.430	0.438
	y	0.433	0.414	0.421	0.440
Bin Q1	x	0.414	0.409	0.424	0.430
	y	0.414	0.400	0.407	0.421
Bin Q0	x	0.409	0.402	0.416	0.424
	y	0.400	0.382	0.389	0.407
Bin QA	x	0.416	0.402	0.396	0.410
	y	0.389	0.382	0.367	0.374

Tolerance: ±0.01

Neutral White	Color Limits (Chromaticity Coordinates)				
		x	y	z	w
Bin RM	x	0.421	0.414	0.397	0.402
	y	0.433	0.414	0.406	0.423
Bin R1	x	0.414	0.409	0.392	0.397
	y	0.414	0.400	0.391	0.406
Bin R0	x	0.392	0.387	0.402	0.409
	y	0.391	0.374	0.382	0.400
Bin RA	x	0.387	0.383	0.396	0.402
	y	0.374	0.360	0.367	0.382
Bin SM	x	0.402	0.397	0.382	0.386
	y	0.423	0.406	0.397	0.413
Bin S1	x	0.397	0.392	0.378	0.382
	y	0.406	0.391	0.382	0.397
Bin S0	x	0.392	0.387	0.374	0.378
	y	0.391	0.374	0.366	0.382
Bin SA	x	0.387	0.383	0.370	0.374
	y	0.374	0.360	0.351	0.366
Bin TM	x	0.386	0.382	0.365	0.367
	y	0.413	0.397	0.386	0.400
Bin TN	x	0.382	0.378	0.362	0.365
	y	0.397	0.382	0.372	0.386
Bin T0	x	0.378	0.374	0.360	0.362
	y	0.382	0.366	0.357	0.372
Bin TP	x	0.374	0.370	0.357	0.360
	y	0.366	0.351	0.342	0.357

Tolerance: ±0.01

Packaging Option [x₄]

Selection	Option
1	Tape and Reel

Color	Bin ID	Min.	Max.	
Red	–	620.0	635.0	
	Amber	A	584.5	587.0
		B	587.0	589.5
		C	589.5	592.0
		D	592.0	594.5
E		594.5	597.0	
Blue	A	460.0	465.0	
	B	465.0	470.0	
	C	470.0	475.0	
	D	475.0	480.0	
Green	A	515.0	520.0	
	B	520.0	525.0	
	C	525.0	530.0	
	D	530.0	535.0	

Tolerance: ±1 nm

Example

ASMT-JY11-NST01

ASMT-JY11-Nxxxx – Warm White, InGaN,
Electrically isolated Heat Sink

- X₁ = S – Minimum Flux Bin S
- X₂ = T – Maximum Flux Bin T
- X₃ = 0 – Full Distribution
- X₄ = 1 – Tape and Reel Option

Tape and Reel – Option 1

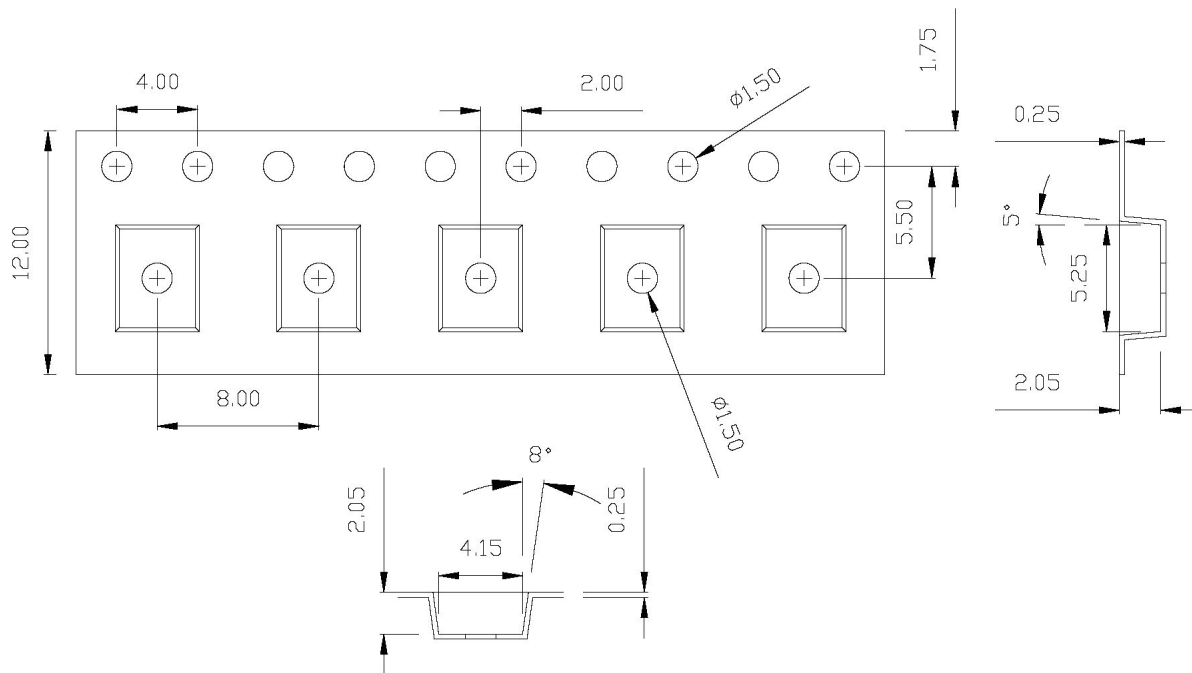
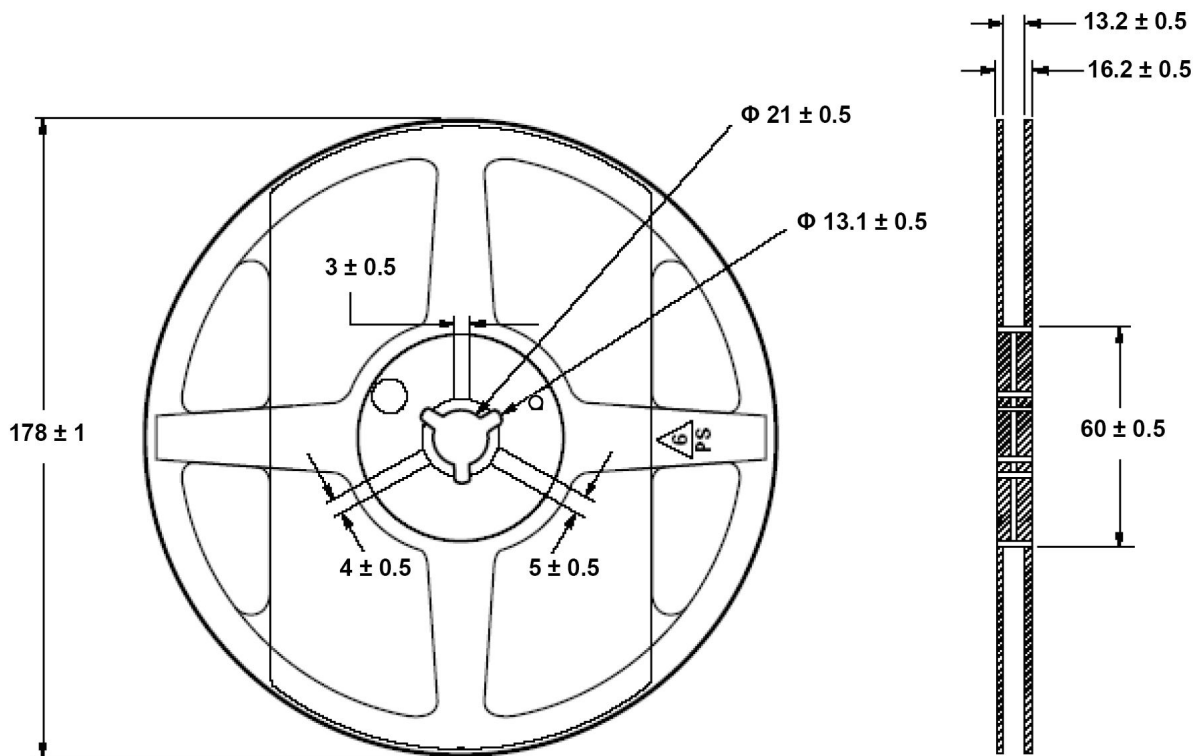

Figure 24. Carrier Tape Dimensions.



Notes:

1. Empty component pockets sealed with top cover tape.
2. 250 or 500 pieces per reel.
3. Drawing not to scale.
4. All dimensions are in millimeters.

Figure 25. Reel dimensions.

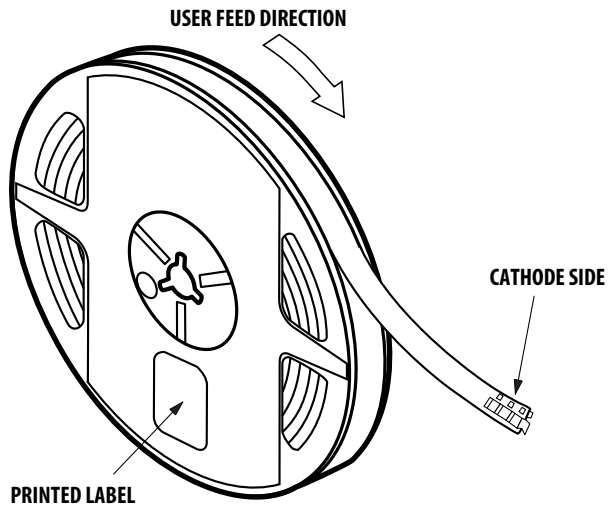

Figure 26. Reeling Orientation.

DISCLAIMER: Avago's products and software are not specifically designed, manufactured or authorized for sale as parts, components or assemblies for the planning, construction, maintenance or direct operation of a nuclear facility or for use in medical devices or applications. Customer is solely responsible, and waives all rights to make claims against avago or its suppliers, for all loss, damage, expense or liability in connection with such use.

For product information and a complete list of distributors, please go to our web site: www.avagotech.com

Avago, Avago Technologies, and the A logo are trademarks of Avago Technologies in the United States and other countries. Data subject to change. Copyright © 2005-2009 Avago Technologies. All rights reserved. AV02-1770EN - February 6, 2009

AVAGO
TECHNOLOGIES