

## Features

- Low  $R_{DS(ON)}$ :
  - $45m\Omega$  @  $V_{GS} = -10V$
  - $65m\Omega$  @  $V_{GS} = -4.5V$
- Low Input/Output Leakage
- **Lead Free By Design/RoHS Compliant (Note 3)**
- **Qualified to AEC-Q101 Standards for High Reliability**
- **"Green" Device (Note 4)**

## Mechanical Data

- Case: SOT-26, Molded Plastic
- Case Material - UL Flammability Rating 94V-0
- Moisture Sensitivity: Level 1 per J-STD-020D
- Terminals: Finish - Matte Tin annealed over Copper leadframe. Solderable per MIL-STD-202, Method 208
- Terminal Connections: See Diagram
- Marking Information: See Page 4
- Ordering Information: See page 4
- Weight: 0.008 grams (approximate)

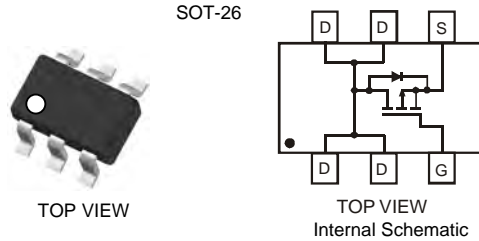

## Maximum Ratings @ $T_A = 25^\circ C$ unless otherwise specified

Characteristic	Symbol	Value	Unit
Drain-Source Voltage	$V_{DSS}$	-30	V
Gate-Source Voltage	$V_{GSS}$	$\pm 20$	V
Drain Current (Note 1) Continuous	$I_D$	-4.3 -3.7	A
		$T_A = 25^\circ C$ $T_A = 70^\circ C$	
Pulsed Drain Current (Note 2)	$I_{DM}$	-13	A

## Thermal Characteristics

Characteristic	Symbol	Value	Unit
Total Power Dissipation (Note 1)	$P_D$	1.25	W
Thermal Resistance, Junction to Ambient (Note 1); Steady-State	$R_{\theta JA}$	100	$^\circ C/W$
Operating and Storage Temperature Range	$T_J, T_{STG}$	-55 to +150	$^\circ C$

- Notes:
1. Device mounted on 1"x1", FR-4 PC board on 0.1in.<sup>2</sup> pads on 2 oz. Copper pads and test pulse width  $t \leq 10s$ .
  2. Repetitive Rating, pulse width limited by junction temperature.
  3. No purposefully added lead.
  4. Diodes Inc's "Green" policy can be found on our website at [http://www.diodes.com/products/lead\\_free/index.php](http://www.diodes.com/products/lead_free/index.php).

**Electrical Characteristics** @T<sub>A</sub> = 25°C unless otherwise specified

Characteristic	Symbol	Min	Typ	Max	Unit	Test Condition
<b>STATIC PARAMETERS</b>						
Drain-Source Breakdown Voltage	BV <sub>DSS</sub>	-30	—	—	V	V <sub>GS</sub> = 0V, I <sub>D</sub> = -250μA
Zero Gate Voltage Drain Current	I <sub>DSS</sub>	—	—	-1	μA	T <sub>J</sub> = 25°C V <sub>GS</sub> = 0V, V <sub>DS</sub> = -30V
Gate-Body Leakage Current	I <sub>GSS</sub>	—	—	±100 ±800	nA	V <sub>GS</sub> = ±20V, V <sub>DS</sub> = 0V V <sub>GS</sub> = ±25V, V <sub>DS</sub> = 0V
Gate Threshold Voltage	V <sub>GS(th)</sub>	-1.0	—	-2.1	V	V <sub>GS</sub> = V <sub>DS</sub> , I <sub>D</sub> = -250μA
Static Drain-Source On-Resistance (Note 5)	R <sub>DS(on)</sub>	—	—	45 65	mΩ	V <sub>GS</sub> = -10V, I <sub>D</sub> = -4.3A V <sub>GS</sub> = -4.5V, I <sub>D</sub> = -3.7A
Forward Transconductance (Note 5)	g <sub>FS</sub>	—	8	—	S	V <sub>DS</sub> = -10V, I <sub>D</sub> = -4.3A
Diode Forward Voltage (Note 5)	V <sub>SD</sub>	—	—	-1.2	V	V <sub>GS</sub> = 0V, I <sub>S</sub> = -1.7A
<b>DYNAMIC PARAMETERS (Note 6)</b>						
Input Capacitance	C <sub>iss</sub>	—	722	—	pF	V <sub>GS</sub> = 0V, V <sub>DS</sub> = -25V, f = 1.0MHz
Output Capacitance	C <sub>oss</sub>	—	114	—	pF	
Reverse Transfer Capacitance	C <sub>rss</sub>	—	92	—	pF	
Gate Resistance	R <sub>G</sub>	—	3.3	—	Ω	V <sub>DS</sub> = 0V, V <sub>GS</sub> = 0V f = 1.0MHz
<b>SWITCHING CHARACTERISTICS</b>						
Total Gate Charge	Q <sub>G</sub>	—	6.8	—	nC	V <sub>DS</sub> = -15V, V <sub>GS</sub> = -4.5V, I <sub>D</sub> = -6A
	Q <sub>G</sub>	—	13.7	—	nC	
Gate-Source Charge	Q <sub>GS</sub>	—	1.6	—	nC	V <sub>DS</sub> = -15V, V <sub>GS</sub> = -10V, I <sub>D</sub> = -6A
Gate-Drain Charge	Q <sub>GD</sub>	—	4.2	—	nC	
Turn-On Delay Time	t <sub>d(on)</sub>	—	6.4	—	ns	V <sub>DS</sub> = -15V, V <sub>GS</sub> = -10V, I <sub>D</sub> = -1A, R <sub>G</sub> = 6.0Ω
Rise Time	t <sub>r</sub>	—	5.3	—		
Turn-Off Delay Time	t <sub>d(off)</sub>	—	26.5	—		
Fall Time	t <sub>f</sub>	—	14.7	—		

Notes: 5. Test pulse width t = 300μs.  
6. Guaranteed by design. Not subject to production testing.

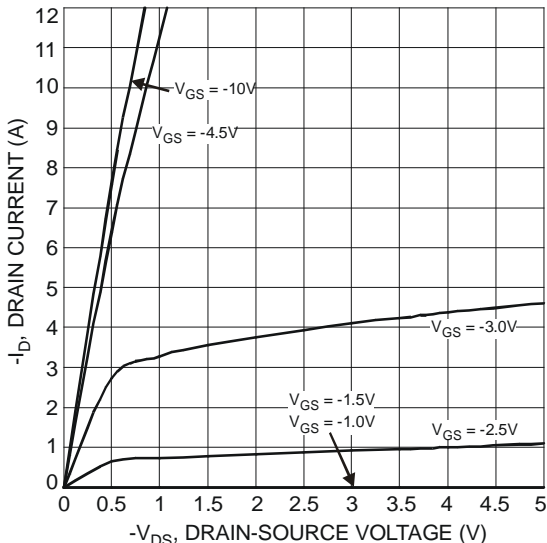

Fig. 1 Typical Output Characteristics

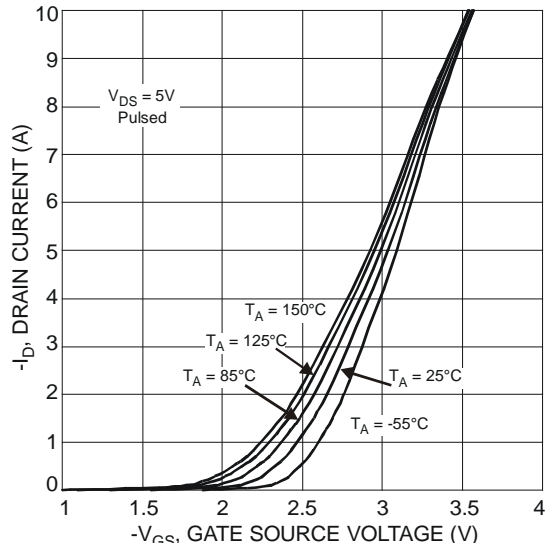

Fig. 2 Typical Transfer Characteristics

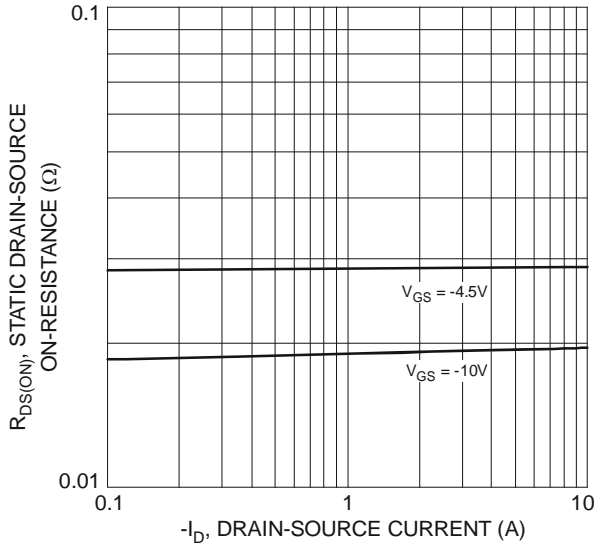

Fig. 3 On-Resistance vs. Drain Current & Gate Voltage

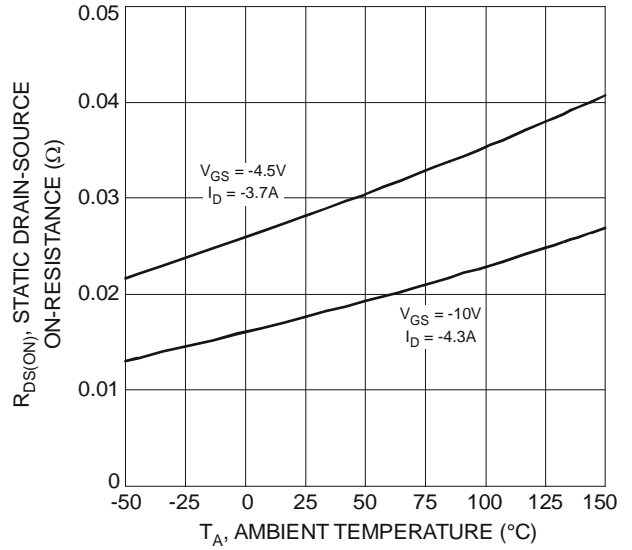

Fig. 4 Static Drain-Source On-Resistance vs. Ambient Temperature

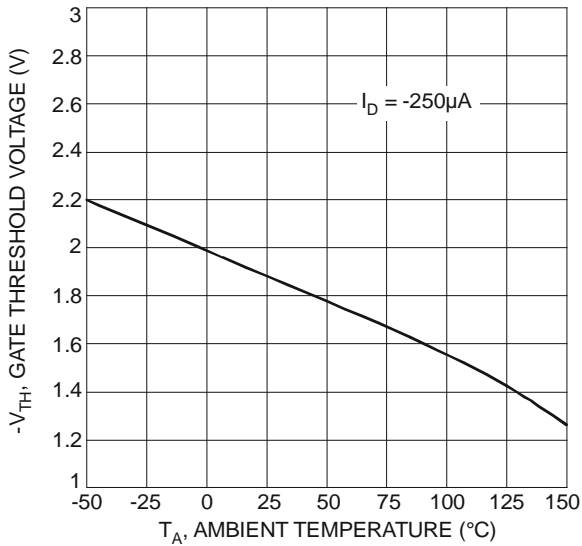

Fig. 5 Gate Threshold Variation vs. Ambient Temperature

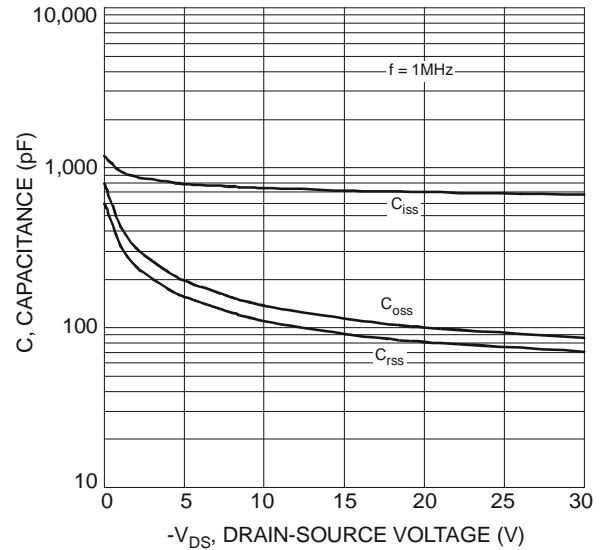

Fig. 6 Typical Total Capacitance

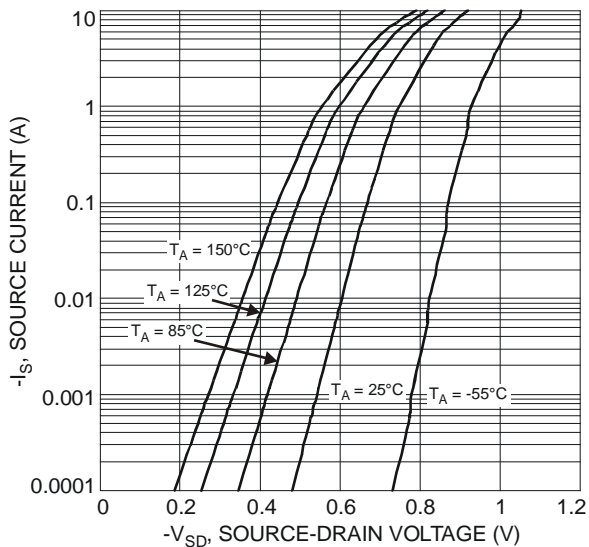

Fig. 7 Reverse Drain Current vs. Source-Drain Voltage

**Ordering Information** (Note 7)

Part Number	Case	Packaging
DMP3056LDM-7	SOT-26	3000/Tape & Reel

Notes: 7. For packaging details, go to our website at <http://www.diodes.com/datasheets/ap02007.pdf>.

**Marking Information**

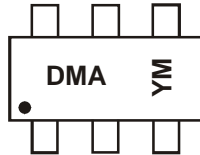

DMA = Product Type Marking Code  
 YM = Date Code Marking  
 Y = Year (ex: V = 2008)  
 M = Month (ex: 9 = September)

Date Code Key

Year	2008	2009	2010	2011	2012	2013	2014	2015
Code	V	W	X	Y	Z	A	B	C

Month	Jan	Feb	Mar	Apr	May	Jun	Jul	Aug	Sep	Oct	Nov	Dec
Code	1	2	3	4	5	6	7	8	9	O	N	D

**Package Outline Dimensions**

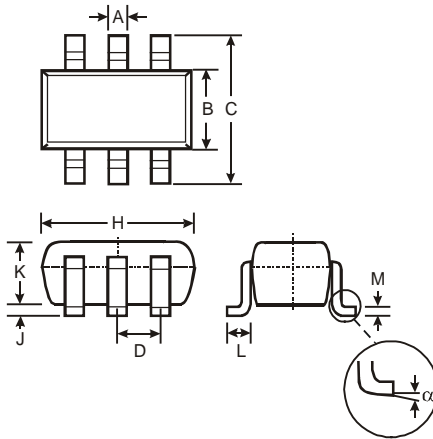

SOT-26			
Dim	Min	Max	Typ
A	0.35	0.50	0.38
B	1.50	1.70	1.60
C	2.70	3.00	2.80
D	—	—	0.95
H	2.90	3.10	3.00
J	0.013	0.10	0.05
K	1.00	1.30	1.10
L	0.35	0.55	0.40
M	0.10	0.20	0.15
α	0°	8°	—
All Dimensions in mm			

**Suggested Pad Layout**

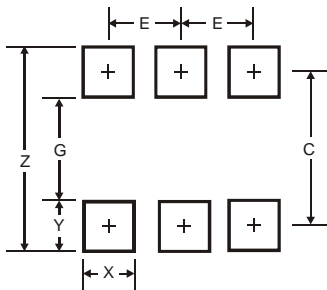

Dimensions	Value (in mm)
Z	3.20
G	1.60
X	0.55
Y	0.80
C	2.40
E	0.95

**IMPORTANT NOTICE**

Diodes Incorporated and its subsidiaries reserve the right to make modifications, enhancements, improvements, corrections or other changes without further notice to any product herein. Diodes Incorporated does not assume any liability arising out of the application or use of any product described herein; neither does it convey any license under its patent rights, nor the rights of others. The user of products in such applications shall assume all risks of such use and will agree to hold Diodes Incorporated and all the companies whose products are represented on our website, harmless against all damages.

**LIFE SUPPORT**

Diodes Incorporated products are not authorized for use as critical components in life support devices or systems without the expressed written approval of the President of Diodes Incorporated.