

20V N-CHANNEL ENHANCEMENT MODE MOSFET

SUMMARY

$V_{(BR)DSS}=20V$; $R_{DS(ON)}=0.040\Omega$; $I_D=5.4A$

DESCRIPTION

This new generation of high density MOSFETs from Zetex utilises a unique structure that combines the benefits of low on-resistance with fast switching speed. This makes them ideal for high efficiency, low voltage, power management applications.

FEATURES

- Low on-resistance
- Fast switching speed
- Low threshold
- Low gate drive
- Low profile SOIC package

APPLICATIONS

- DC - DC Converters
- Power Management Functions
- Disconnect switches
- Motor control

ORDERING INFORMATION

DEVICE	REEL SIZE (inches)	TAPE WIDTH (mm)	QUANTITY PER REEL
ZXM64N02XTA	7	12mm embossed	1000 units
ZXM64N02XTC	13	12mm embossed	4000 units

DEVICE MARKING

- ZXM64N02



MSOP8

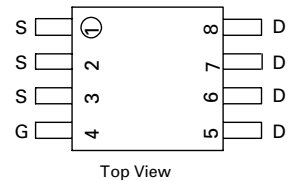
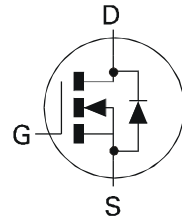

ZXM64N02X

ABSOLUTE MAXIMUM RATINGS.

PARAMETER	SYMBOL	LIMIT	UNIT
Drain-Source Voltage	V_{DSS}	20	V
Gate- Source Voltage	V_{GS}	± 12	V
Continuous Drain Current ($V_{GS}=4.5V$; $T_A=25^\circ C$)(b) ($V_{GS}=4.5V$; $T_A=70^\circ C$)(b)	I_D	5.4 4.3	A
Pulsed Drain Current (c)	I_{DM}	30	A
Continuous Source Current (Body Diode)(b)	I_S	2.4	A
Pulsed Source Current (Body Diode)(c)	I_{SM}	30	A
Power Dissipation at $T_A=25^\circ C$ (a) Linear Derating Factor	P_D	1.1 8.8	W mW/ $^\circ C$
Power Dissipation at $T_A=25^\circ C$ (b) Linear Derating Factor	P_D	1.8 14.4	W mW/ $^\circ C$
Operating and Storage Temperature Range	$T_j:T_{stg}$	-55 to +150	$^\circ C$

THERMAL RESISTANCE

PARAMETER	SYMBOL	VALUE	UNIT
Junction to Ambient (a)	$R_{\theta JA}$	113	$^\circ C/W$
Junction to Ambient (b)	$R_{\theta JA}$	70	$^\circ C/W$

NOTES

(a) For a device surface mounted on 25mm x 25mm FR4 PCB with high coverage of single sided 1oz copper, in still air conditions

(b) For a device surface mounted on FR4 PCB measured at $t \leq 10$ secs.

(c) Repetitive rating - pulse width limited by maximum junction temperature. Refer to Transient Thermal Impedance graph.

TYPICAL CHARACTERISTICS

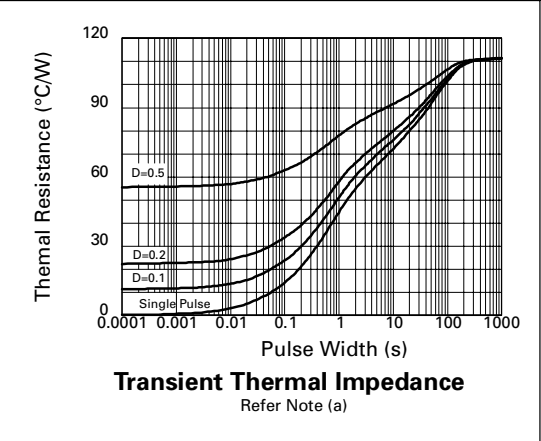
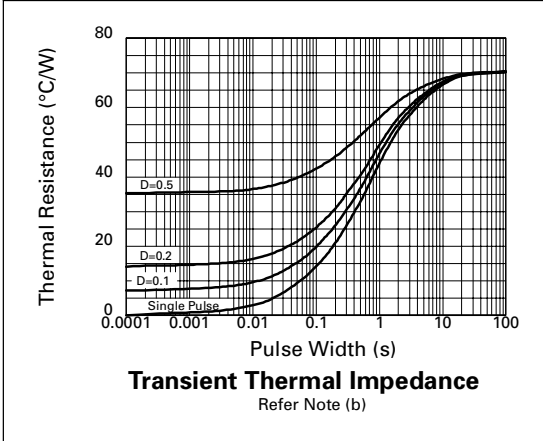
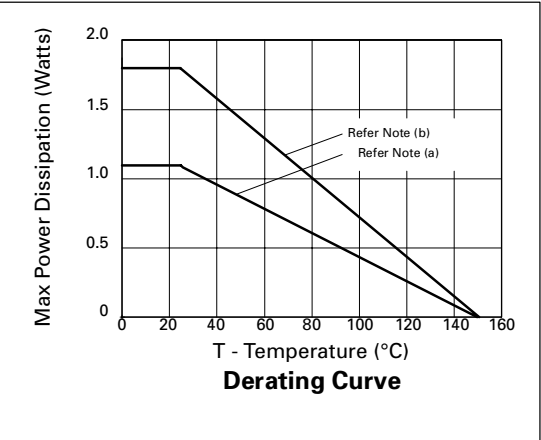
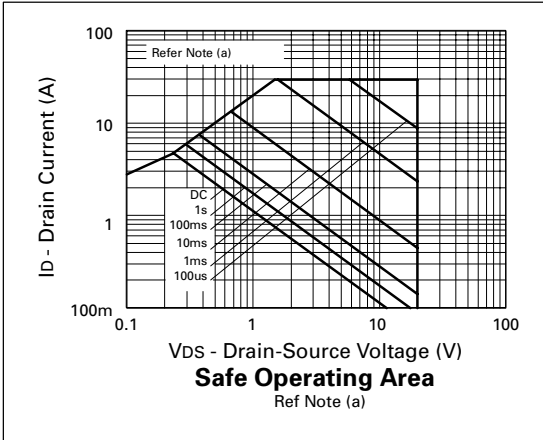

ZXM64N02X

ELECTRICAL CHARACTERISTICS (at $T_{amb} = 25^{\circ}\text{C}$ unless otherwise stated).

PARAMETER	SYMBOL	MIN.	TYP.	MAX.	UNIT	CONDITIONS.
STATIC						
Drain-Source Breakdown Voltage	$V_{(BR)DSS}$	20			V	$I_D=250\mu\text{A}, V_{GS}=0\text{V}$
Zero Gate Voltage Drain Current	I_{DSS}			1	μA	$V_{DS}=20\text{V}, V_{GS}=0\text{V}$
Gate-Body Leakage	I_{GSS}			100	nA	$V_{GS}=\pm 12\text{V}, V_{DS}=0\text{V}$
Gate-Source Threshold Voltage	$V_{GS(th)}$	0.7			V	$I_D=250\mu\text{A}, V_{DS}=V_{GS}$
Static Drain-Source On-State Resistance (1)	$R_{DS(on)}$			0.040 0.050	Ω Ω	$V_{GS}=4.5\text{V}, I_D=3.8\text{A}$ $V_{GS}=2.7\text{V}, I_D=1.9\text{A}$
Forward Transconductance (3)	g_{fs}	6.1			S	$V_{DS}=10\text{V}, I_D=1.9\text{A}$
DYNAMIC (3)						
Input Capacitance	C_{iss}		1100		pF	$V_{DS}=15\text{V}, V_{GS}=0\text{V},$ $f=1\text{MHz}$
Output Capacitance	C_{oss}		350		pF	
Reverse Transfer Capacitance	C_{rss}		100		pF	
SWITCHING(2) (3)						
Turn-On Delay Time	$t_{d(on)}$		5.7		ns	$V_{DD}=10\text{V}, I_D=3.8\text{A}$ $R_G=6.2\Omega, R_D=2.6\Omega$ (Refer to test circuit)
Rise Time	t_r		9.6		ns	
Turn-Off Delay Time	$t_{d(off)}$		28.3		ns	
Fall Time	t_f		11.6		ns	
Total Gate Charge	Q_g			16	nC	
Gate-Source Charge	Q_{gs}			3.5	nC	$V_{DS}=16\text{V}, V_{GS}=4.5\text{V},$ $I_D=3.8\text{A}$ (Refer to test circuit)
Gate Drain Charge	Q_{gd}			5.4	nC	
SOURCE-DRAIN DIODE						
Diode Forward Voltage (1)	V_{SD}			0.95	V	$T_j=25^{\circ}\text{C}, I_S=3.8\text{A},$ $V_{GS}=0\text{V}$
Reverse Recovery Time (3)	t_{rr}		23.7		ns	$T_j=25^{\circ}\text{C}, I_F=3.8\text{A},$ $di/dt=100\text{A}/\mu\text{s}$
Reverse Recovery Charge(3)	Q_{rr}		13.3		nC	

(1) Measured under pulsed conditions. Width=300 μs . Duty cycle $\leq 2\%$.

(2) Switching characteristics are independent of operating junction temperature.

(3) For design aid only, not subject to production testing.

TYPICAL CHARACTERISTICS

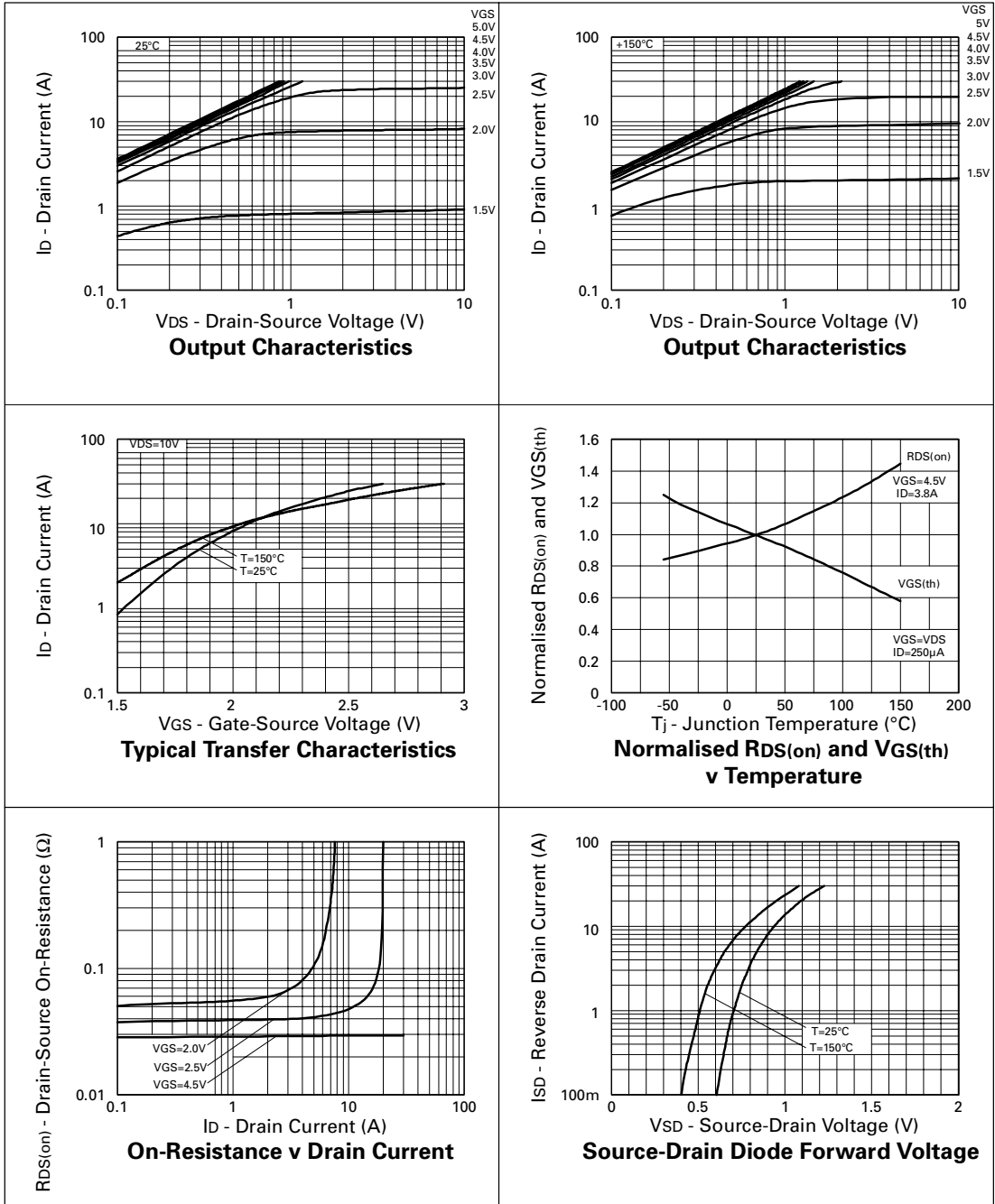

ZXM64N02X

TYPICAL CHARACTERISTICS

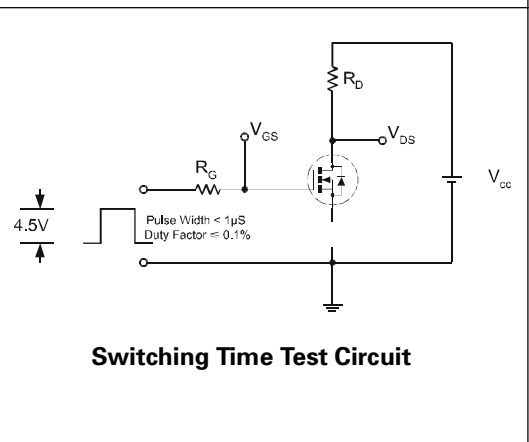
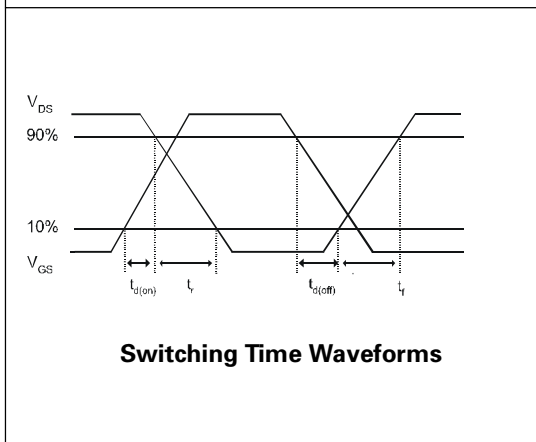
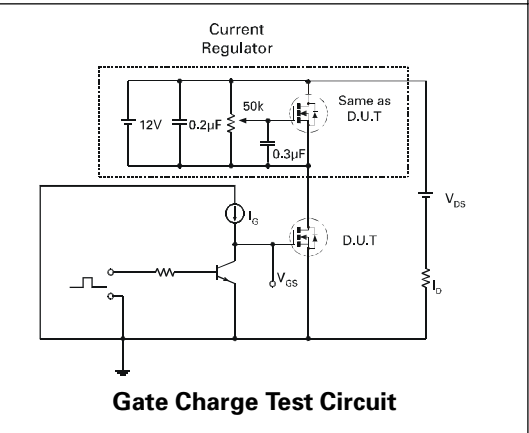
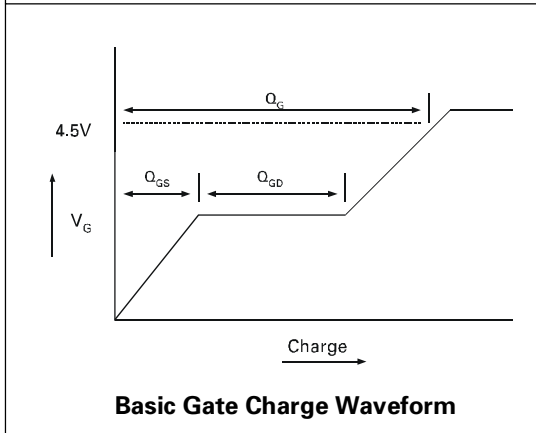
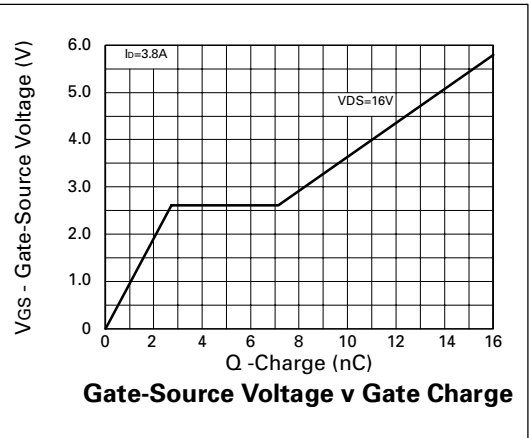
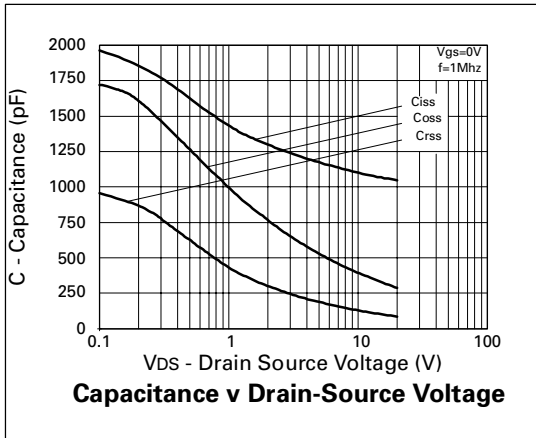

ZXM64N02X

PACKAGE DIMENSIONS

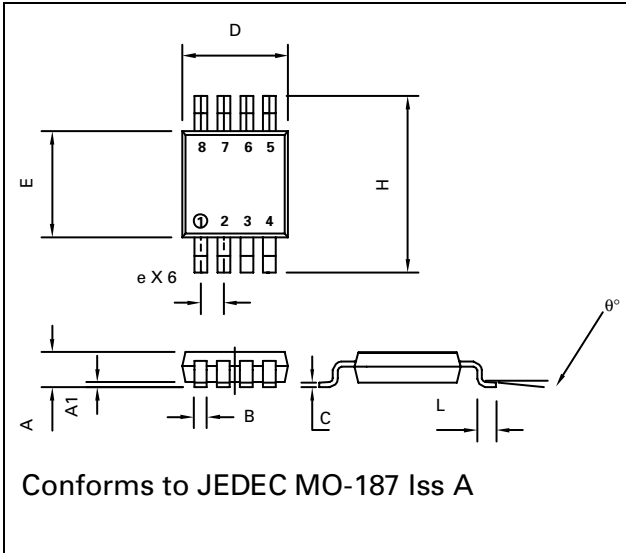

DIM	Millimetres		Inches	
	MIN	MAX	MIN	MAX
A		1.10		0.043
A1	0.05	0.15	0.002	0.006
B	0.25	0.40	0.010	0.016
C	0.13	0.23	0.005	0.009
D	2.90	3.10	0.114	0.122
e	0.65	BSC	0.0256	BSC
E	2.90	3.10	0.114	0.122
H	4.90	BSC	0.193	BSC
L	0.40	0.70	0.016	0.028
q°	0°	6°	0°	6°

PAD LAYOUT DETAILS

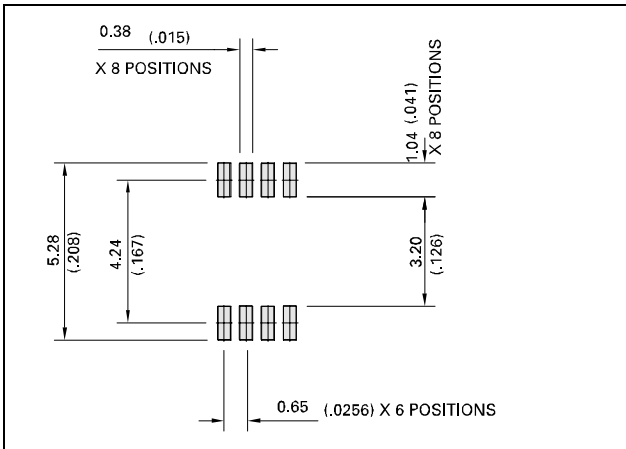

Zetex plc.
Chadderton Technology Park, Chadderton, Oldham, OL9-9LL, United Kingdom.
Telephone: (44)161 622 4422 (Sales), (44)161 622 4444 (General Enquiries)
Fax: (44)161 622 4420

Zetex GmbH
Kustermann-park
D-81541 München
Germany
Telephone: (49) 89 45 49 49 0
Fax: (49) 89 45 49 49 49

Zetex Inc.
700 Veterans Mem. Highway
Hauppauge, NY 11788
USA
Telephone: (516) 543-7100
Fax: (516) 864-7630

Zetex (Asia) Ltd.
Metroplaza, Tower 1
Hing Fong Road
Kwai Fong, Hong Kong
Telephone: (852) 26100 611
Fax: (852) 24250 494

These are supported by
agents and distributors in
major countries world-wide
©Zetex plc 1999

Internet: <http://www.zetex.com>

This publication is issued to provide outline information only which (unless agreed by the Company in writing) may not be used, applied or reproduced for any purpose or form part of any order or contract or be regarded as a representation relating to the products or services concerned. The Company reserves the right to alter without notice the specification, design, price or conditions of supply of any product or service.

