

Features

- Low On-Resistance
- Low Gate Threshold Voltage
- Low Input Capacitance
- Fast Switching Speed
- Available in Lead Free/RoHS Compliant Version (Note 4)
- Qualified to AEC-Q101 Standards for High Reliability
- "Green" Device (Note 5 and 6)

Mechanical Data

- Case: SOT-363
- Case Material: Molded Plastic. "Green" Molding Compound. UL Flammability Classification Rating 94V-0
- Moisture Sensitivity: Level 1 per J-STD-020C
- Terminals: Solderable per MIL-STD-202, Method 208
- Also Available in Lead Free Plating (Matte Tin Finish annealed over Alloy 42 leadframe). Please see Ordering Information, Note 8, on Page 3
- Terminal Connections: See Diagram
- Marking Information: See Page 3
- Ordering Information: See Page 3
- Weight: 0.006 grams (approximate)



TOP VIEW

SOT-363

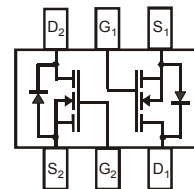

TOP VIEW
Internal Schematic

Maximum Ratings @ $T_A = 25^\circ\text{C}$ unless otherwise specified

Characteristic	Symbol	BSS138DW	Units
Drain-Source Voltage	V_{DSS}	50	V
Drain-Gate Voltage (Note 3)	V_{DGR}	50	V
Gate-Source Voltage	V_{GSS}	± 20	V
Drain Current (Note 1)	I_D	200	mA

Thermal Characteristics @ $T_A = 25^\circ\text{C}$ unless otherwise specified

Characteristic	Symbol	BSS138DW	Units
Total Power Dissipation (Note 1)	P_d	200	mW
Thermal Resistance, Junction to Ambient	$R_{\theta JA}$	625	$^\circ\text{C/W}$
Operating and Storage Temperature Range	T_j, T_{STG}	-55 to +150	$^\circ\text{C}$

Electrical Characteristics @ $T_A = 25^\circ\text{C}$ unless otherwise specified

Characteristic	Symbol	Min	Typ	Max	Unit	Test Condition
OFF CHARACTERISTICS (Note 2)						
Drain-Source Breakdown Voltage	BV_{DSS}	50	75	—	V	$V_{GS} = 0V, I_D = 250\mu\text{A}$
Zero Gate Voltage Drain Current	I_{DSS}	—	—	0.5	μA	$V_{DS} = 50V, V_{GS} = 0V$
Gate-Body Leakage	I_{GSS}	—	—	± 100	nA	$V_{GS} = \pm 20V, V_{DS} = 0V$
ON CHARACTERISTICS (Note 2)						
Gate Threshold Voltage	$V_{GS(th)}$	0.5	1.2	1.5	V	$V_{DS} = V_{GS}, I_D = 250\mu\text{A}$
Static Drain-Source On-Resistance	$R_{DS(on)}$	—	1.4	3.5	Ω	$V_{GS} = 10V, I_D = 0.22A$
Forward Transconductance	g_{FS}	100	—	—	mS	$V_{DS} = 25V, I_D = 0.2A, f = 1.0\text{KHz}$
DYNAMIC CHARACTERISTICS						
Input Capacitance	C_{iss}	—	—	50	pF	$V_{DS} = 10V, V_{GS} = 0V, f = 1.0\text{MHz}$
Output Capacitance	C_{oss}	—	—	25	pF	
Reverse Transfer Capacitance	C_{rss}	—	—	8.0	pF	
SWITCHING CHARACTERISTICS						
Turn-On Delay Time	$t_{D(ON)}$	—	—	20	ns	$V_{DD} = 30V, I_D = 0.2A, R_{GEN} = 50\Omega$
Turn-Off Delay Time	$t_{D(OFF)}$	—	—	20	ns	

- Notes:
1. Device mounted on FR-4 PCB, 1 inch x 0.85 inch x 0.062 inch; pad layout as shown on Diodes Inc. suggested pad layout document AP02001, which can be found on our website at <http://www.diodes.com/datasheets/ap02001.pdf>.
 2. Short duration pulse test used to minimize self-heating effect.
 3. $R_{\theta SS} \leq 20\text{K}\Omega$.
 4. No purposefully added lead.
 5. Diodes Inc.'s "Green" policy can be found on our website at http://www.diodes.com/products/lead_free/index.php.
 6. Product manufactured with Date Code UO (week 40, 2007) and newer are built with Green Molding Compound. Product manufactured prior to Date Code UO are built with Non-Green Molding Compound and may contain Halogens or Sb2O3 Fire Retardants.

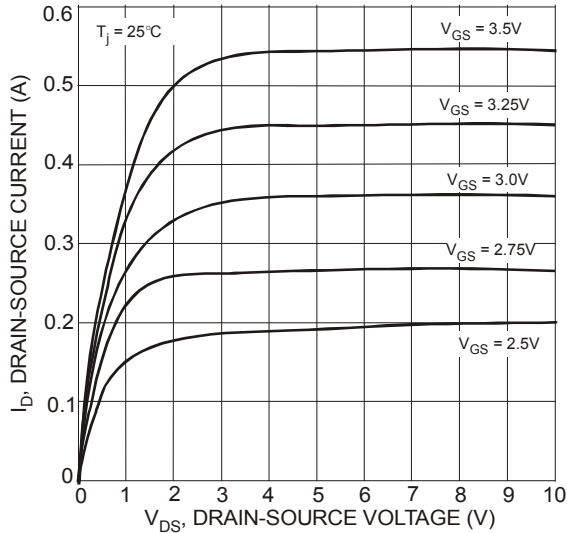

Fig. 1 Drain-Source Current vs. Drain-Source Voltage

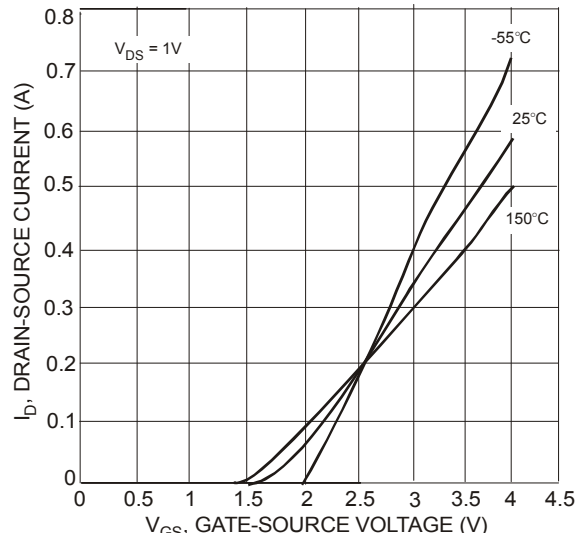

Fig. 2 Transfer Characteristics

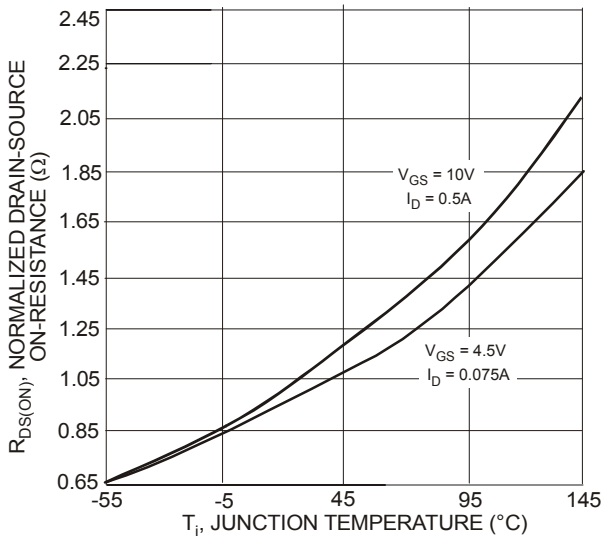

Fig. 3 Drain-Source On Resistance vs. Junction Temperature

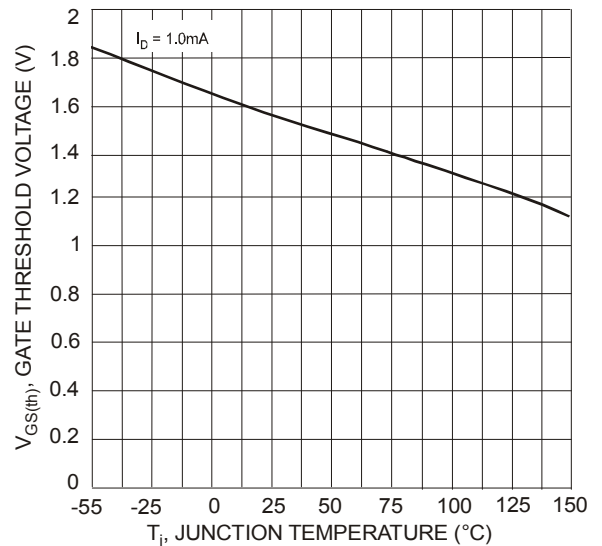

Fig. 4 Gate Threshold Voltage vs. Junction Temperature

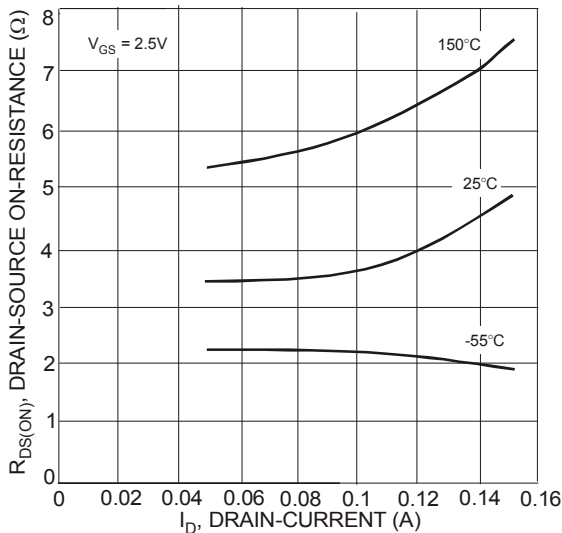

Fig. 5 Drain-Source On-Resistance vs. Drain-Current

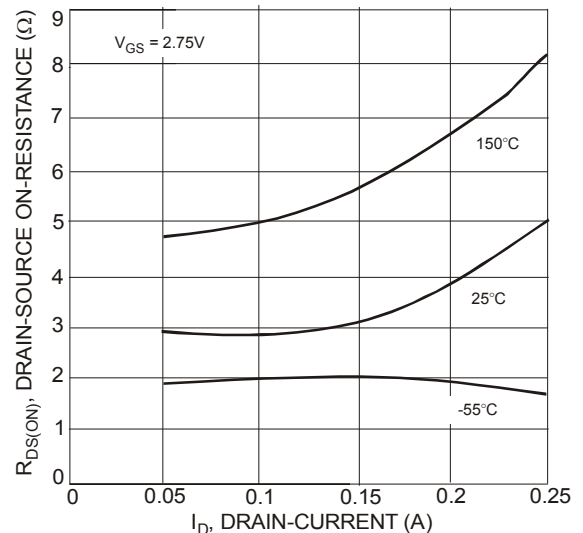

Fig. 6 Drain-Source On-Resistance vs. Drain-Current

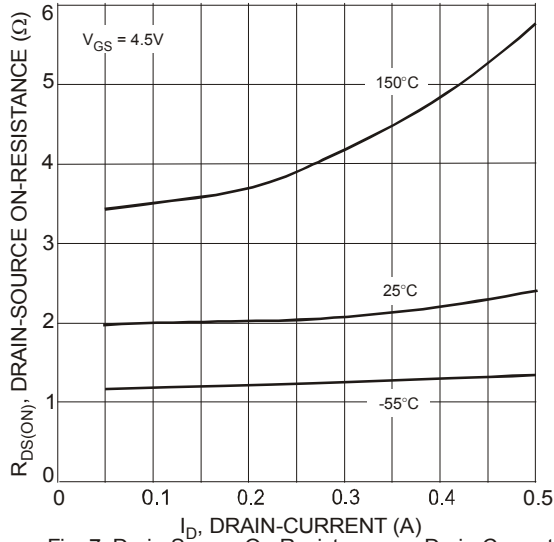

Fig. 7 Drain-Source On-Resistance vs. Drain-Current

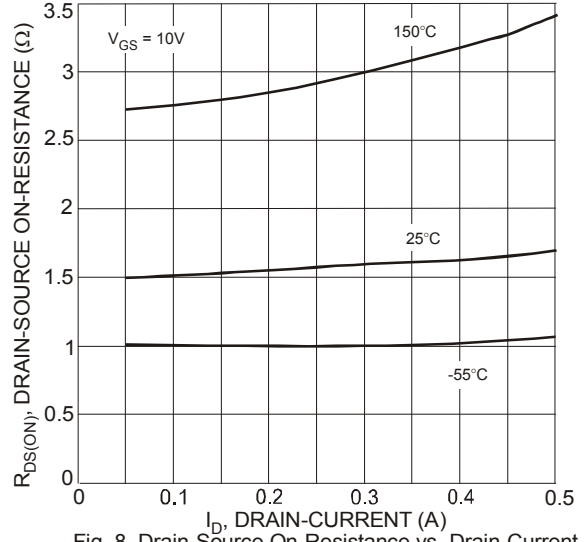

Fig. 8 Drain-Source On-Resistance vs. Drain-Current

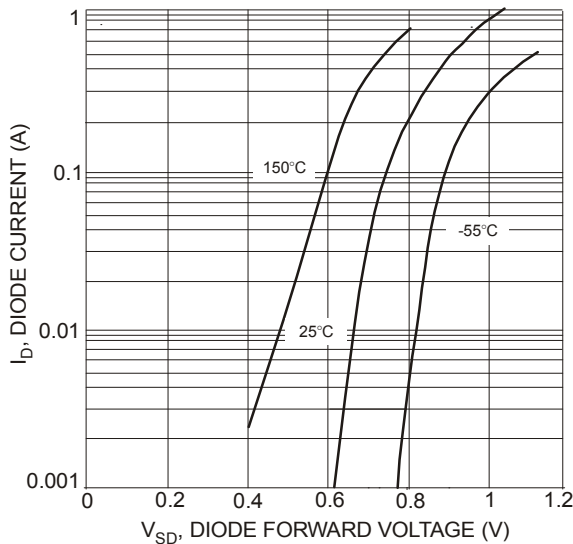

Fig. 9 Body Diode Current vs. Body Diode Voltage

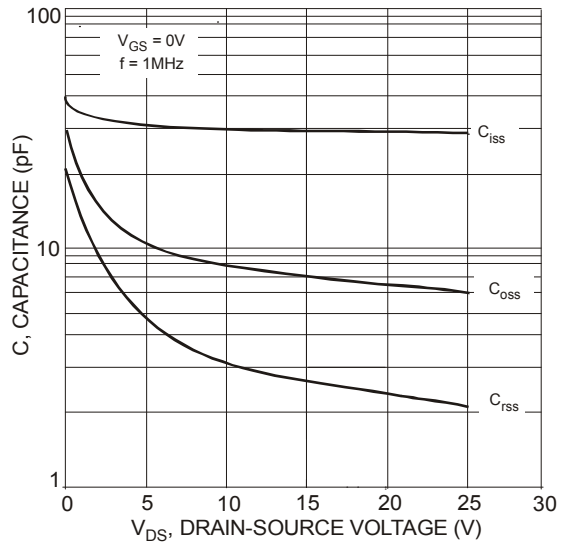

Fig. 10 Capacitance vs. Drain-Source Voltage

Ordering Information (Notes 7 & 8)

Part Number	Case	Packaging
BSS138DW-7	SOT-363	3000/Tape & Reel

- Notes: 7. For packaging details, go to our website at <http://www.diodes.com/datasheets/ap02007.pdf>.
8. For Lead Free/RoHS Compliant version part number, please add "-F" suffix to the part number above. Example: BSS138DW-7-F.

Marking Information

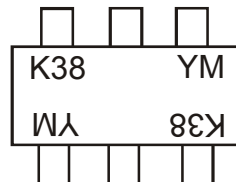

K38 = Product Type Marking Code
YM = Date Code Marking
Y = Year ex: N = 2002
M = Month ex: 9 = September

Date Code Key

Year	1998	1999	2000	2001	2002	2003	2004	2005	2006	2007	2008	2009	2010	2011	2012
Code	J	K	L	M	N	P	R	S	T	U	V	W	X	Y	Z
Month	Jan	Feb	Mar	Apr	May	Jun	Jul	Aug	Sep	Oct	Nov	Dec			
Code	1	2	3	4	5	6	7	8	9	O	N	D			

Package Outline Dimensions

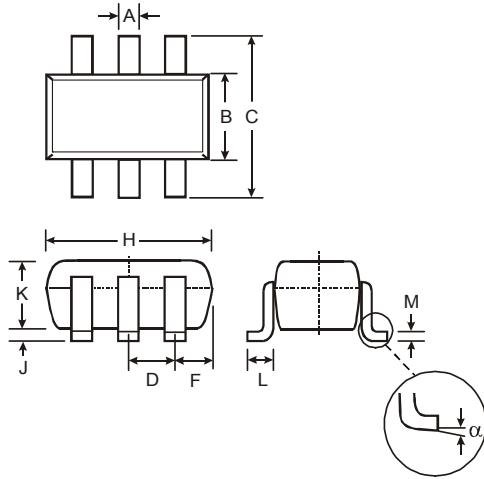

SOT-363		
Dim	Min	Max
A	0.10	0.30
B	1.15	1.35
C	2.00	2.20
D	0.65 Nominal	
F	0.30	0.40
H	1.80	2.20
J	—	0.10
K	0.90	1.00
L	0.25	0.40
M	0.10	0.25
α	0°	8°
All Dimensions in mm		

Suggested Pad Layout

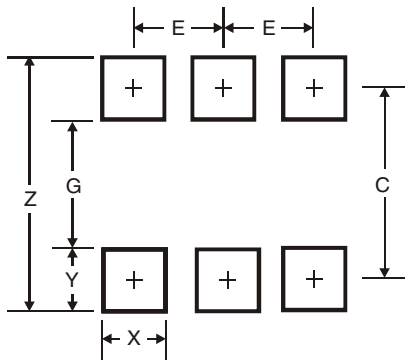

Dimensions	Value (in mm)
Z	2.5
G	1.3
X	0.42
Y	0.6
C	1.9
E	0.65

IMPORTANT NOTICE

Diodes Incorporated and its subsidiaries reserve the right to make modifications, enhancements, improvements, corrections or other changes without further notice to any product herein. Diodes Incorporated does not assume any liability arising out of the application or use of any product described herein; neither does it convey any license under its patent rights, nor the rights of others. The user of products in such applications shall assume all risks of such use and will agree to hold Diodes Incorporated and all the companies whose products are represented on our website, harmless against all damages.

LIFE SUPPORT

Diodes Incorporated products are not authorized for use as critical components in life support devices or systems without the expressed written approval of the President of Diodes Incorporated.