

TELUX™

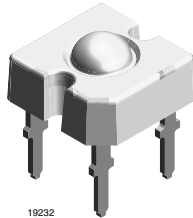

DESCRIPTION

The TELUX™ series is a clear, non diffused LED for applications where supreme luminous flux is required. It is designed in an industry standard 7.62 mm square package utilizing highly developed (AS) AlInGaP technology.

The supreme heat dissipation of TELUX™ allows applications at high ambient temperatures.

All packing units are binned for luminous flux, forward voltage and color to achieve the most homogenous light appearance in application.

SAE and ECE color requirements for automobile application are available for color red.

FEATURES

- Utilizing one of the world's brightest (AS) AlInGaP technologies
- High luminous flux
- Supreme heat dissipation: R_{thJP} is 90 K/W
- High operating temperature:
 $T_{amb} = -40$ to $+110$ °C
- Meets SAE and ECE color requirements for the automobile industry for color red
- Packed in tubes for automatic insertion
- Luminous flux, forward voltage and color categorized for each tube
- Small mechanical tolerances allow precise usage of external reflectors or lightguides
- Lead (Pb)-free device
- Component in accordance to RoHS 2002/95/EC and WEEE 2002/96/EC
- Compatible with wave solder processes acc. to CECC 00802 and J-STD-020C
- ESD-withstand voltage:
up to 2 kV according to JESD22-A114-B
- Qualified according Vishay automotive requirement



APPLICATIONS

- Exterior lighting
- Dashboard illumination
- Tail-, Stop - and Turn Signals of motor vehicles
- Replaces small incandescent lamps
- Traffic signals and signs

PRODUCT GROUP AND PACKAGE DATA

- Product group: LED
- Product series: TELUX Power
- Package: TELUX™ Standard
- Angle of half intensity: $\pm 30^\circ$

PARTS TABLE		
PART	COLOR, LUMINOUS FLUX	TECHNOLOGY
TLWR8600	Red, $\phi_V = 3000$ mlm (typ.)	AlInGaP on GaAs
TLWY8600	Yellow, $\phi_V = 3000$ mlm (typ.)	AlInGaP on GaAs



ABSOLUTE MAXIMUM RATINGS¹⁾ TLWR8600, TLWY8600				
PARAMETER	TEST CONDITION	SYMBOL	VALUE	UNIT
Reverse voltage ²⁾	$I_R = 100 \mu\text{A}$	V_R	10	V
DC Forward current	$T_{\text{amb}} \leq 85 \text{ }^\circ\text{C}$	I_F	70	mA
Surge forward current	$t_p \leq 10 \mu\text{s}$	I_{FSM}	1	A
Power dissipation		P_V	187	mW
Junction temperature		T_j	125	$^\circ\text{C}$
Operating temperature range		T_{amb}	- 40 to + 110	$^\circ\text{C}$
Storage temperature range		T_{stg}	- 55 to + 110	$^\circ\text{C}$
Soldering temperature	$t \leq 5 \text{ s}$, 1.5 mm from body preheat temperature 100 $^\circ\text{C}$ / 30 sec.	T_{sd}	260	$^\circ\text{C}$
Thermal resistance junction/ambient	with cathode heatsink of 70 mm ²	R_{thJA}	200	K/W
Thermal resistance junction/pin		R_{thJP}	90	K/W

Note:

¹⁾ $T_{\text{amb}} = 25 \text{ }^\circ\text{C}$, unless otherwise specified

²⁾ Driving the LED in reverse direction is suitable for a short term application

OPTICAL AND ELECTRICAL CHARACTERISTICS¹⁾ TLWR8600, RED						
PARAMETER	TEST CONDITION	SYMBOL	MIN	TYP.	MAX	UNIT
Total flux	$I_F = 70 \text{ mA}$, $R_{\text{thJA}} = 200 \text{ }^\circ\text{K/W}$	ϕ_V	2000	3000		mlm
Luminous intensity/Total flux	$I_F = 70 \text{ mA}$, $R_{\text{thJA}} = 200 \text{ }^\circ\text{K/W}$	I_V/ϕ_V		0.8		mcd/mlm
Dominant wavelength	$I_F = 70 \text{ mA}$, $R_{\text{thJA}} = 200 \text{ }^\circ\text{K/W}$	λ_d	611	615	634	nm
Peak wavelength	$I_F = 70 \text{ mA}$, $R_{\text{thJA}} = 200 \text{ }^\circ\text{K/W}$	λ_p		624		nm
Angle of half intensity	$I_F = 70 \text{ mA}$, $R_{\text{thJA}} = 200 \text{ }^\circ\text{K/W}$	φ		± 30		deg
Total included angle	90 % of Total Flux Captured	$\varphi_{0.9V}$		75		deg
Forward voltage	$I_F = 70 \text{ mA}$, $R_{\text{thJA}} = 200 \text{ }^\circ\text{K/W}$	V_F	1.83	2.2	2.67	V
Reverse voltage	$I_R = 10 \mu\text{A}$	V_R	10	20		V
Junction capacitance	$V_R = 0$, $f = 1 \text{ MHz}$	C_j		17		pF

Note:

¹⁾ $T_{\text{amb}} = 25 \text{ }^\circ\text{C}$, unless otherwise specified

OPTICAL AND ELECTRICAL CHARACTERISTICS¹⁾ TLWY8600, YELLOW						
PARAMETER	TEST CONDITION	SYMBOL	MIN	TYP.	MAX	UNIT
Total flux	$I_F = 70 \text{ mA}$, $R_{\text{thJA}} = 200 \text{ }^\circ\text{K/W}$	ϕ_V	2000	3000		mlm
Luminous intensity/Total flux	$I_F = 70 \text{ mA}$, $R_{\text{thJA}} = 200 \text{ }^\circ\text{K/W}$	I_V/ϕ_V		0.8		mcd/mlm
Dominant wavelength	$I_F = 70 \text{ mA}$, $R_{\text{thJA}} = 200 \text{ }^\circ\text{K/W}$	λ_d	585	590	597	nm
Peak wavelength	$I_F = 70 \text{ mA}$, $R_{\text{thJA}} = 200 \text{ }^\circ\text{K/W}$	λ_p		594		nm
Angle of half intensity	$I_F = 70 \text{ mA}$, $R_{\text{thJA}} = 200 \text{ }^\circ\text{K/W}$	φ		± 30		deg
Total included angle	90 % of Total Flux Captured	$\varphi_{0.9V}$		75		deg
Forward voltage	$I_F = 70 \text{ mA}$, $R_{\text{thJA}} = 200 \text{ }^\circ\text{K/W}$	V_F	1.83	2.1	2.67	V
Reverse voltage	$I_R = 10 \mu\text{A}$	V_R	10	15		V
Junction capacitance	$V_R = 0$, $f = 1 \text{ MHz}$	C_j		17		pF

Note:

¹⁾ $T_{\text{amb}} = 25 \text{ }^\circ\text{C}$, unless otherwise specified

LUMINOUS FLUX CLASSIFICATION		
GROUP STANDARD	LUMINOUS FLUX (MLM)	
	MIN	MAX
D	2000	3000
E	2500	3600
F	3000	4200
G	3500	4800
H	4000	6100
I	5000	7300
K	6000	9700
L	7000	12200
M	8000	15000

Note:

Luminous flux is tested at a current pulse duration of 25 ms and an accuracy of $\pm 11\%$.

The above type numbers represent the order groups which include only a few brightness groups. Only one group will be shipped on each tube (there will be no mixing of two groups on each tube).

In order to ensure availability, single brightness groups will be not orderable.

In a similar manner for colors where wavelength groups are measured and binned, single wavelength groups will be shipped in any one tube.

In order to ensure availability, single wavelength groups will not be orderable.

TYPICAL CHARACTERISTICS

$T_{amb} = 25\text{ }^{\circ}\text{C}$, unless otherwise specified

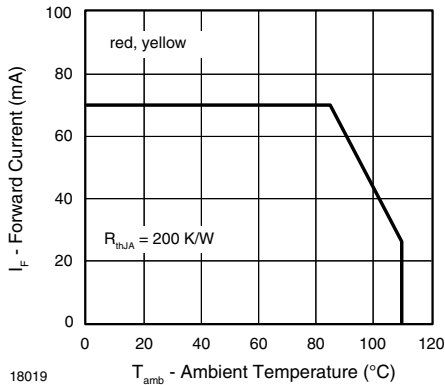

Figure 1. Forward Current vs. Ambient Temperature

COLOR CLASSIFICATION				
GROUP	DOM. WAVELENGTH (NM)			
	YELLOW		RED	
	MIN.	MAX.	MIN.	MAX.
0	585	588		
1	587	591	611	618
2	589	594	614	622
3	592	597	616	634

Note:

Wavelengths are tested at a current pulse duration of 25 ms and an accuracy of $\pm 1\text{ nm}$.

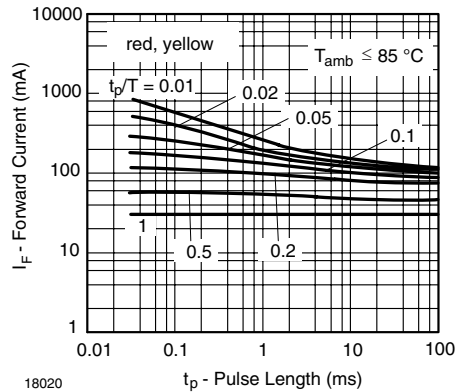

Figure 2. Forward Current vs. Pulse Length

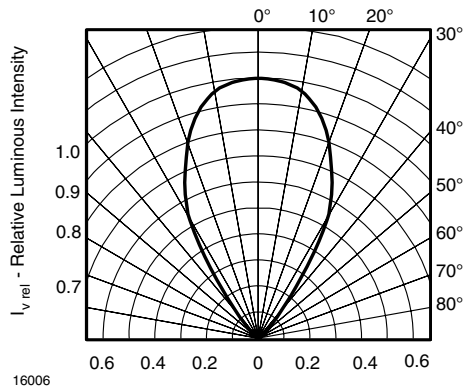

Figure 3. Rel. Luminous Intensity vs. Angular Displacement

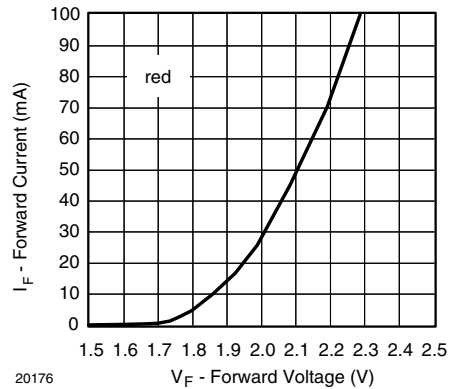

Figure 6. Forward Current vs. Forward Voltage

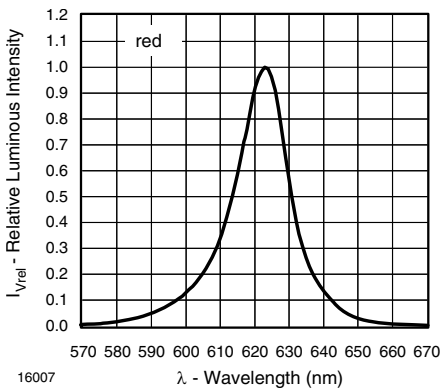

Figure 4. Relative Intensity vs. Wavelength

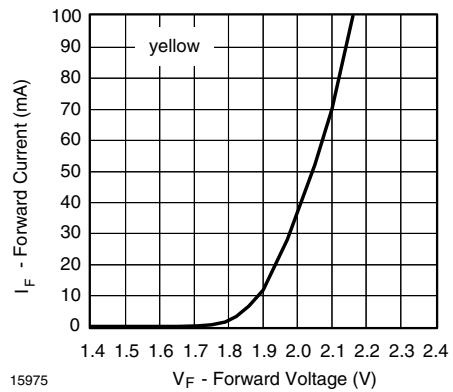

Figure 7. Forward Current vs. Forward Voltage

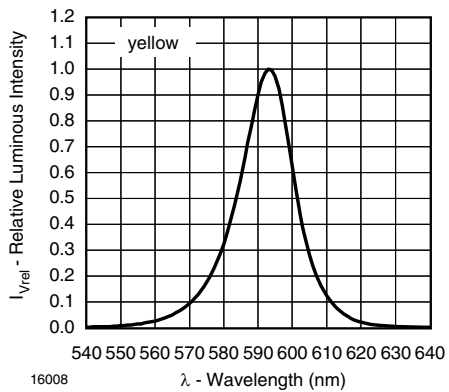

Figure 5. Relative Intensity vs. Wavelength

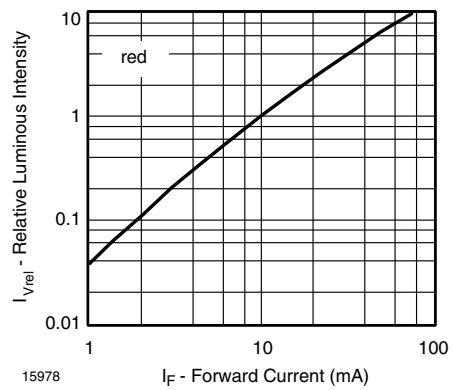

Figure 8. Relative Luminous Flux vs. Forward Current

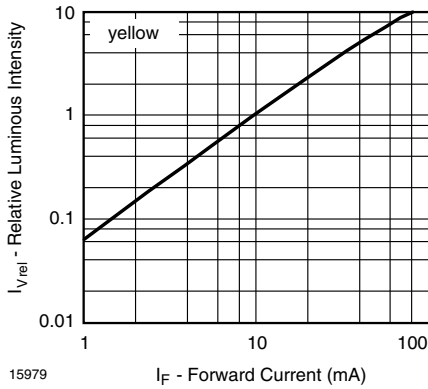

Figure 9. Relative Luminous Flux vs. Forward Current

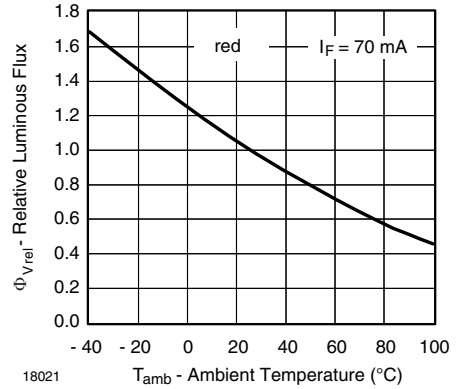

Figure 12. Rel. Luminous Flux vs. Ambient Temperature

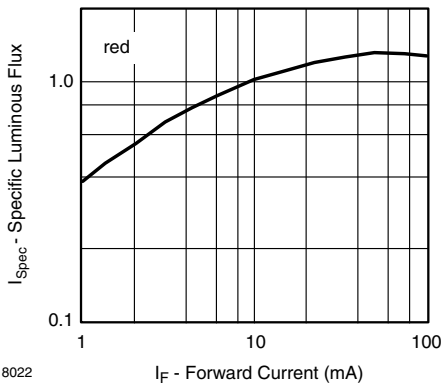

Figure 10. Specific Luminous Flux vs. Forward Current

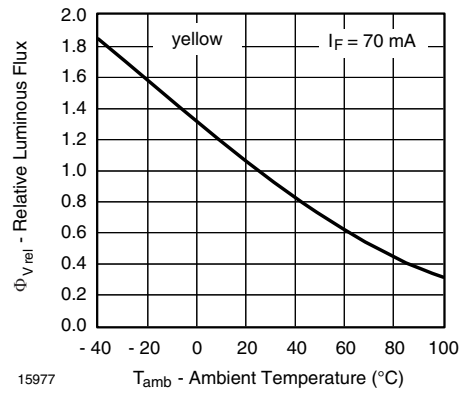

Figure 13. Rel. Luminous Flux vs. Ambient Temperature

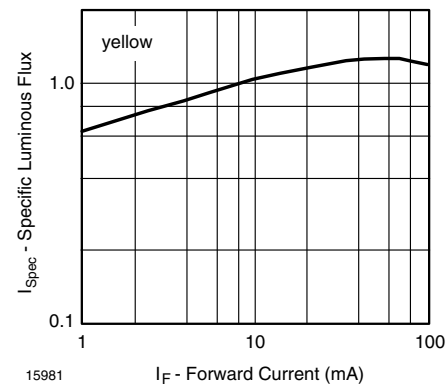

Figure 11. Specific Luminous Flux vs. Forward Current

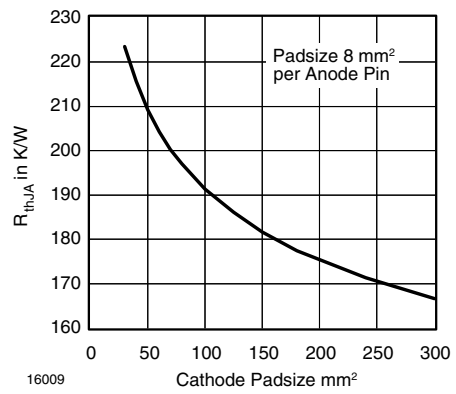

Figure 14. Thermal Resistance Junction Ambient vs. Cathode Padsizes

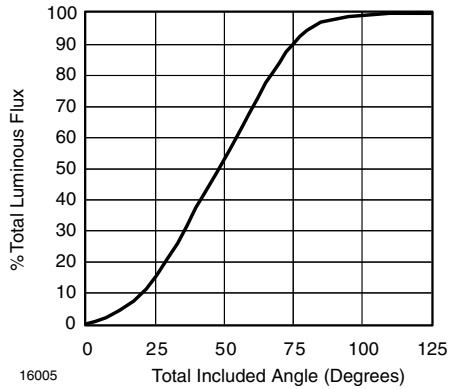
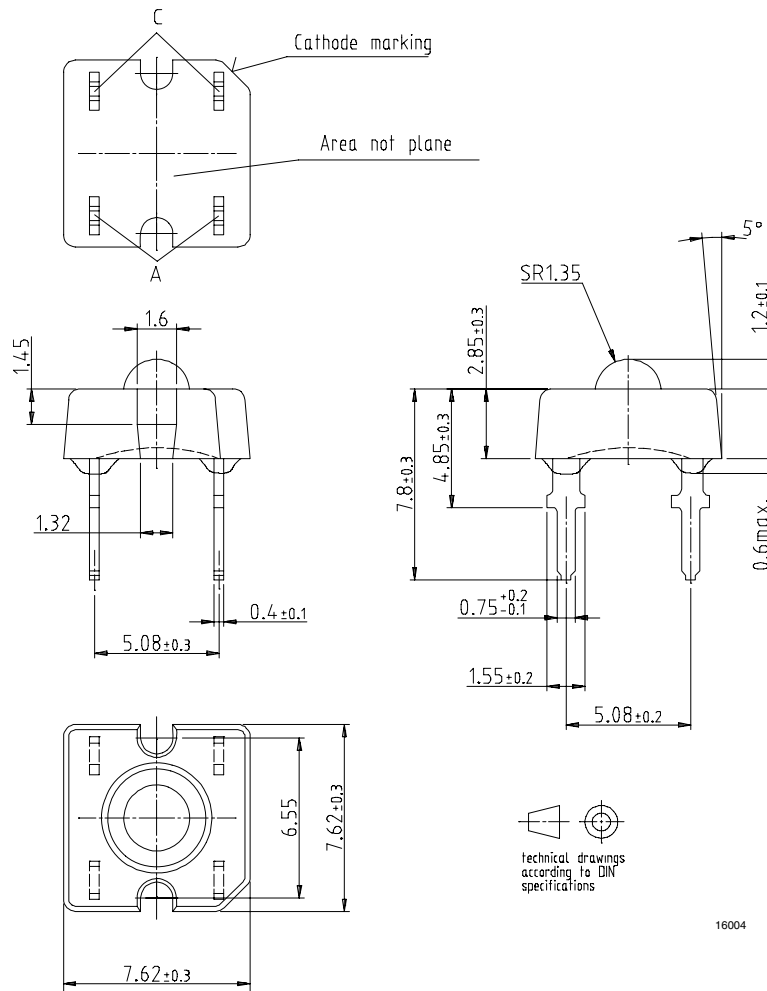

Figure 15. Percentage Total Luminous Flux vs. Total Included Angle for 60° emission angle

PACKAGE DIMENSIONS in millimeters



16004



Ozone Depleting Substances Policy Statement

It is the policy of Vishay Semiconductor GmbH to

1. Meet all present and future national and international statutory requirements.
2. Regularly and continuously improve the performance of our products, processes, distribution and operating systems with respect to their impact on the health and safety of our employees and the public, as well as their impact on the environment.

It is particular concern to control or eliminate releases of those substances into the atmosphere which are known as ozone depleting substances (ODSs).

The Montreal Protocol (1987) and its London Amendments (1990) intend to severely restrict the use of ODSs and forbid their use within the next ten years. Various national and international initiatives are pressing for an earlier ban on these substances.

Vishay Semiconductor GmbH has been able to use its policy of continuous improvements to eliminate the use of ODSs listed in the following documents.

1. Annex A, B and list of transitional substances of the Montreal Protocol and the London Amendments respectively
2. Class I and II ozone depleting substances in the Clean Air Act Amendments of 1990 by the Environmental Protection Agency (EPA) in the USA
3. Council Decision 88/540/EEC and 91/690/EEC Annex A, B and C (transitional substances) respectively.

Vishay Semiconductor GmbH can certify that our semiconductors are not manufactured with ozone depleting substances and do not contain such substances.

We reserve the right to make changes to improve technical design
and may do so without further notice.

Parameters can vary in different applications. All operating parameters must be validated for each customer application by the customer. Should the buyer use Vishay Semiconductors products for any unintended or unauthorized application, the buyer shall indemnify Vishay Semiconductors against all claims, costs, damages, and expenses, arising out of, directly or indirectly, any claim of personal damage, injury or death associated with such unintended or unauthorized use.

Vishay Semiconductor GmbH, P.O.B. 3535, D-74025 Heilbronn, Germany



Disclaimer

All product specifications and data are subject to change without notice.

Vishay Intertechnology, Inc., its affiliates, agents, and employees, and all persons acting on its or their behalf (collectively, "Vishay"), disclaim any and all liability for any errors, inaccuracies or incompleteness contained herein or in any other disclosure relating to any product.

Vishay disclaims any and all liability arising out of the use or application of any product described herein or of any information provided herein to the maximum extent permitted by law. The product specifications do not expand or otherwise modify Vishay's terms and conditions of purchase, including but not limited to the warranty expressed therein, which apply to these products.

No license, express or implied, by estoppel or otherwise, to any intellectual property rights is granted by this document or by any conduct of Vishay.

The products shown herein are not designed for use in medical, life-saving, or life-sustaining applications unless otherwise expressly indicated. Customers using or selling Vishay products not expressly indicated for use in such applications do so entirely at their own risk and agree to fully indemnify Vishay for any damages arising or resulting from such use or sale. Please contact authorized Vishay personnel to obtain written terms and conditions regarding products designed for such applications.

Product names and markings noted herein may be trademarks of their respective owners.