

QG030-353/12

DC tangential blower

forward curved



ebm-papst St. Georgen GmbH & Co. KG

Hermann-Papst-Straße 1

74673 St. Georgen

Phone: +49 7724 81-0

Fax: +49 7724 81-1309

www.ebmpapst.com

info2@de.ebmpapst.com

Nominal data

Type	QG030-353/12	
Nominal voltage	[VDC]	12
Power input	[W]	9.6
Min. ambient temperature	[°C]	-20
Max. ambient temperature	[°C]	60
Air flow	[m ³ /h]	155
Sound pressure level	[dB(A)]	51

ml = max. load · me = max. efficiency · rfa = running at free air · cs = customer specs · cu = customer unit
Subject to alterations

Technical features

General description	Cross flow fan with high air flow. Large outflow surface. Electronic commutation completely integrated.
Locked-rotor protection	Blocking and overload protection
Direction of protection	Right, looking at rotor
Bearing	Motor with ball bearing system. Impeller bracket with sliding bearings.
Lifetime L10 at 40 °C	30000 h
Lifetime L10 at maximum temperature	10000 h
Mass	0.415 kg
Housing material	Aluminum, housing side parts of plastic.
Material of impeller	Aluminum
Motor protection	Protected against reverse polarity and locking.
Approval	VDE, CSA, UL, CE

Product drawing

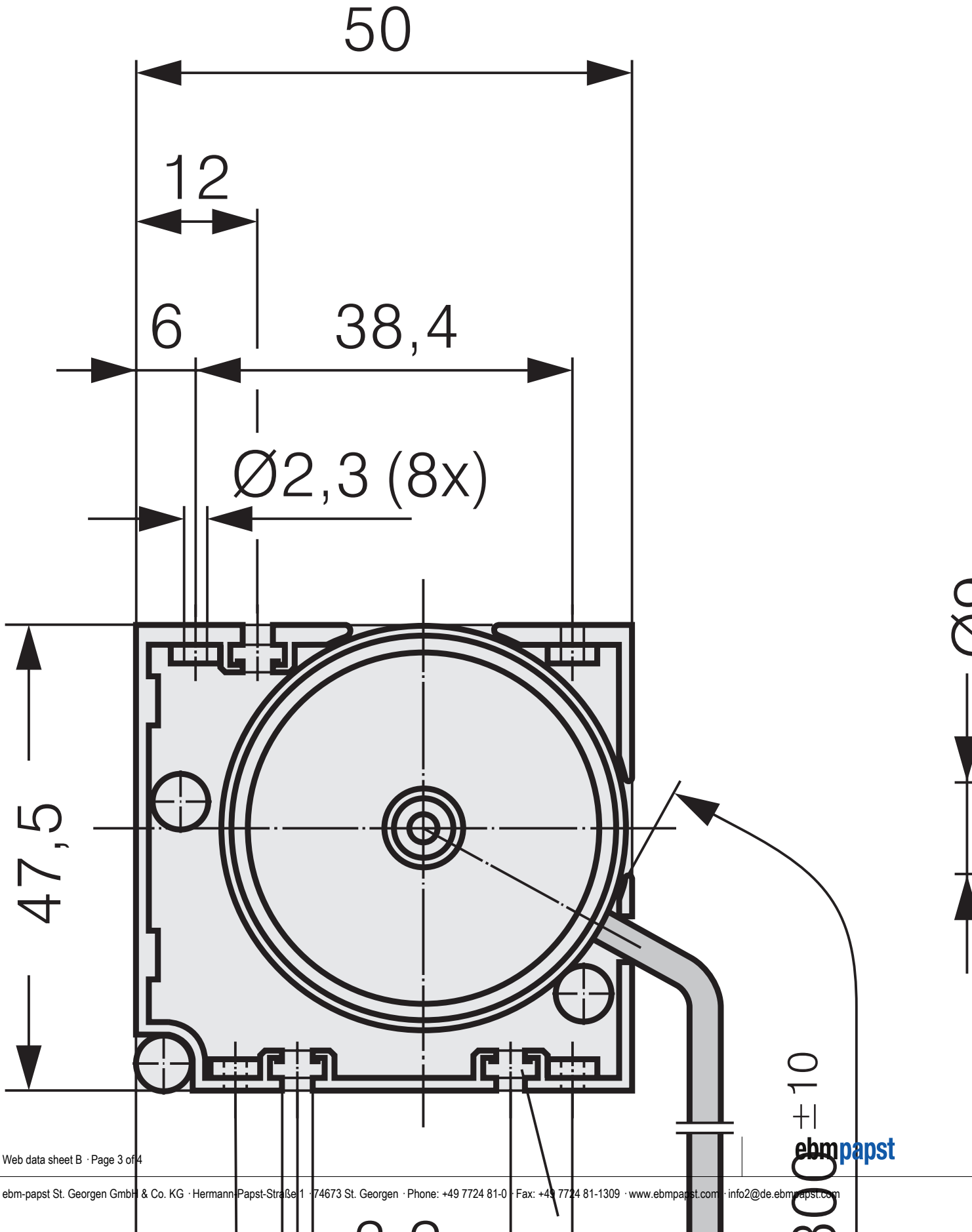

Charts: Air flow

