

**ebm-papst Mulfingen GmbH & Co. KG**

Bachmühle 2

74673 Mulfingen

Phone: +49 7938 81-0

Fax: +49 7938 81-110

www.ebmpapst.com

info1@de.ebmpapst.com

Nominal data

Type	W1G250-HH37-52	
Motor	M1G074-BF	
Nominal voltage	[VDC]	24
Nominal voltage range	[VDC]	16 .. 28
Type of data definition		rfa
Speed	[min ⁻¹]	2750
Power input	[W]	105
Current draw	[A]	5.0
Max. ambient temperature	[°C]	60
Air flow	[m ³ /h]	1920
Back pressure	[Pa]	0

ml = max. load · me = max. efficiency · rfa = running at free air · cs = customer specs · cu = customer unit
Subject to alterations

Technical features

Leakage current	<= 0,25 mA
Dimensions	250 mm
Size	250 mm
Operation mode	Continuous operation (S1)
Electrical leads	Via terminal strip
Direction of air flow	"V"
Insulation class	"B"
Bearing-motor	Ball bearing
Mass	2.5 kg
Housing material	Die-cast aluminum
Material of impeller	Sheet steel, coated in black
Motor protection	Reverse polarity and locked-rotor protection
Type of protection	IP 42
Protection class	I
Technical features	Control input 0-10 VDC / PWM, tach output, polarity and locked rotor protection
Approval	CSA C22.2 Nr.77; UL 1004

Product drawing

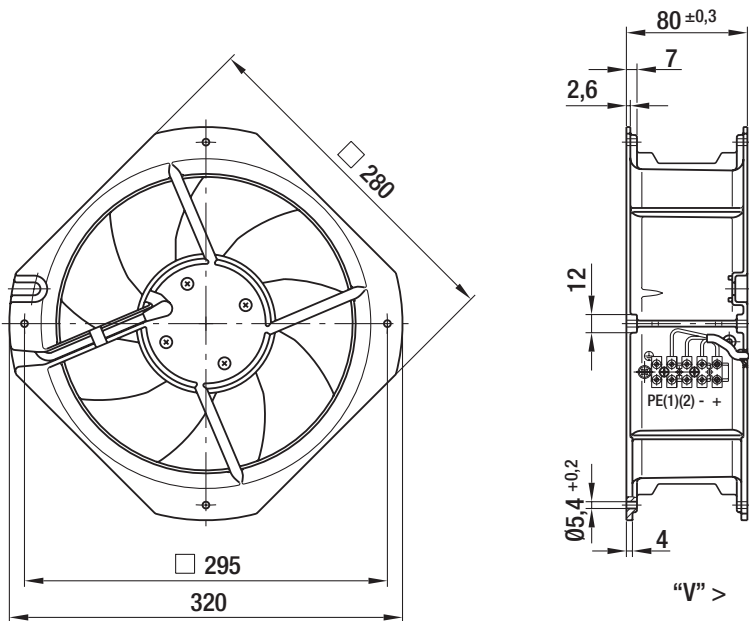

Charts: Air flow

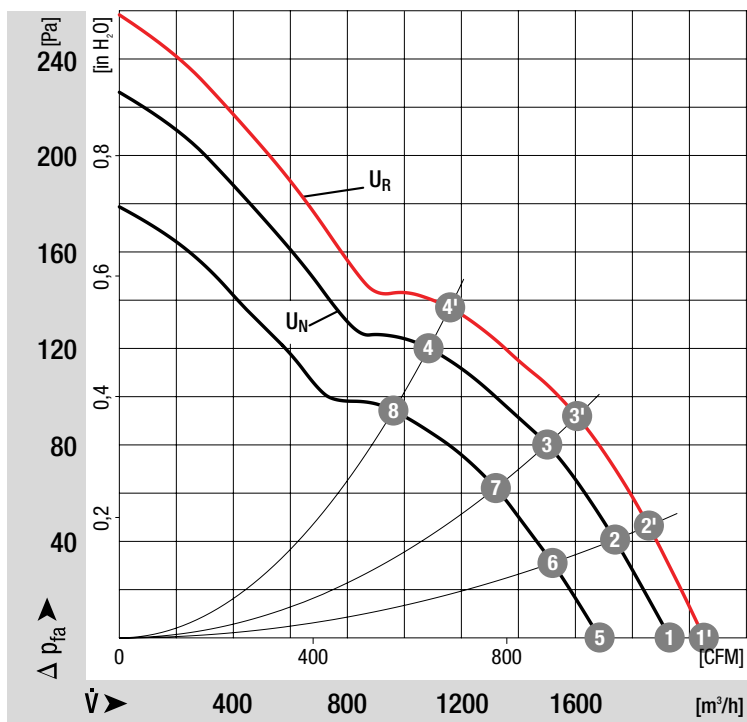

	n	P ₁	η _{TL}
	[min ⁻¹]	[W]	[%]
1'	2920	129	
2'	2800	132	63
3'	2680	135	60
4'	2600	139	45
1	2750	105	
2	2630	110	63
3	2520	111	60
4	2440	114	45
5	2610	73	
6	2320	75	63
7	2230	78	60
8	2170	80	45