

**ebm-papst St. Georgen GmbH & Co. KG**

Hermann-Papst-Straße 1

74673 St. Georgen

Phone: +49 7724 81-0

Fax: +49 7724 81-1309

www.ebmpapst.com

info2@de.ebmpapst.com

**Nominal data**

Type	5318 /2 TDHP	
Nominal voltage	[VDC]	48
Speed	[min <sup>-1</sup> ]	6000
Power input	[W]	41
Min. ambient temperature	[°C]	-20
Max. ambient temperature	[°C]	70
Air flow	[m <sup>3</sup> /h]	410
Sound power level	[B]	7.7
Sound pressure level	[dB(A)]	70

ml = max. load · me = max. efficiency · rfa = running at free air · cs = customer specs · cu = customer unit  
Subject to alterations

**Technical features**

<b>Dimensions</b>	140 x 140 x 51 mm
<b>General description</b>	Very smooth running 3-phase fan drive. Very rigid compression curve for high air flow at high counterpressure. Low operating noise level at high counterpressure. Standard with PWM control input and speed signal. Electronic commutation completely integrated.
<b>Direction of protection</b>	Counterclockwise, looking at rotor
<b>Direction of air flow</b>	Inlet over bars
<b>Bearing</b>	Ball bearings
<b>Lifetime L10 at 40 °C</b>	70000 h
<b>Lifetime L10 at maximum temperature</b>	35000 h
<b>Mass</b>	0.900 kg
<b>Material of impeller</b>	Fiberglass-reinforced PA plastic
<b>Motor protection</b>	Protected against reverse polarity and locking.

## Product drawing

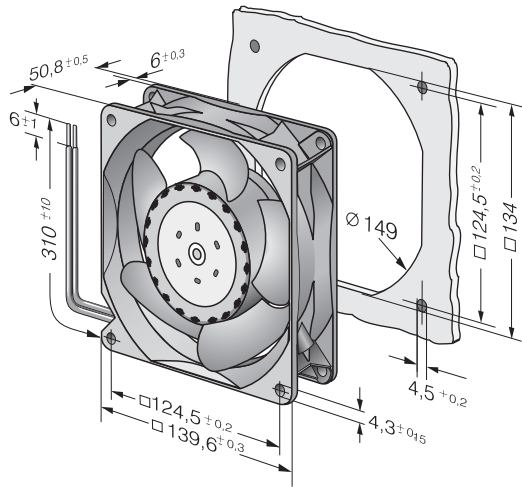

## Charts: Air flow

