

**ebm-papst St. Georgen GmbH & Co. KG**

Hermann-Papst-Straße 1

74673 St. Georgen

Phone: +49 7724 81-0

Fax: +49 7724 81-1309

www.ebmpapst.com

info2@de.ebmpapst.com

**Nominal data**

Type	4114 N/2H7P	
Nominal voltage	[VDC]	24
Speed	[min <sup>-1</sup> ]	9500
Power input	[W]	90
Min. ambient temperature	[°C]	-20
Max. ambient temperature	[°C]	75
Air flow	[m <sup>3</sup> /h]	500
Sound power level	[B]	8.5
Sound pressure level	[dB(A)]	76

ml = max. load · me = max. efficiency · rfa = running at free air · cs = customer specs · cu = customer unit  
Subject to alterations

**Technical features**

<b>Dimensions</b>	119 x 119 x 38 mm
<b>General description</b>	Very rigid compression curve for high air flow at high counterpressure. Low operating noise level at high counterpressure. Standard with PWM control input and speed signal. Very smooth running 3-phase fan drive. Electronic commutation completely integrated.
<b>Connection line</b>	Single strands AWG 20, sensor and control strands AWG 22, UL 1007, TR 64, bared and tin-plated.
<b>Direction of protection</b>	Clockwise, looking at rotor
<b>Direction of air flow</b>	Inlet over bars
<b>Bearing</b>	Ball bearings
<b>Lifetime L10 at 40 °C</b>	57500 h
<b>Lifetime L10 at maximum temperature</b>	25000 h
<b>Mass</b>	0.425 kg
<b>Material of impeller</b>	Fiberglass-reinforced PA plastic
<b>Motor protection</b>	Protected against reverse polarity and locking.

## Product drawing

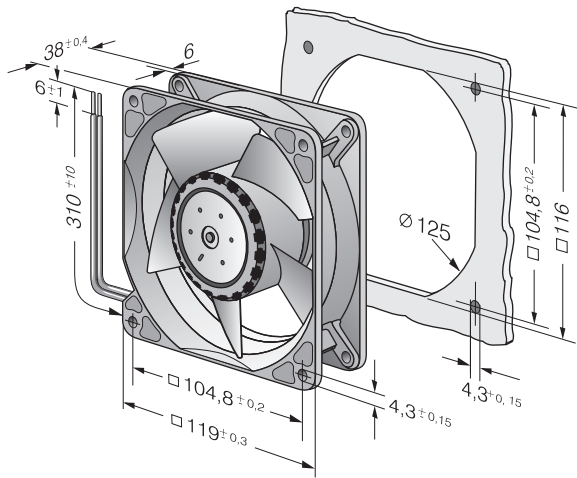

Charts: Air flow

